



This is a digital copy of a book that was preserved for generations on library shelves before it was carefully scanned by Google as part of a project to make the world's books discoverable online.

It has survived long enough for the copyright to expire and the book to enter the public domain. A public domain book is one that was never subject to copyright or whose legal copyright term has expired. Whether a book is in the public domain may vary country to country. Public domain books are our gateways to the past, representing a wealth of history, culture and knowledge that's often difficult to discover.

Marks, notations and other marginalia present in the original volume will appear in this file - a reminder of this book's long journey from the publisher to a library and finally to you.

Usage guidelines

Google is proud to partner with libraries to digitize public domain materials and make them widely accessible. Public domain books belong to the public and we are merely their custodians. Nevertheless, this work is expensive, so in order to keep providing this resource, we have taken steps to prevent abuse by commercial parties, including placing technical restrictions on automated querying.

We also ask that you:

- + *Make non-commercial use of the files* We designed Google Book Search for use by individuals, and we request that you use these files for personal, non-commercial purposes.
- + *Refrain from automated querying* Do not send automated queries of any sort to Google's system: If you are conducting research on machine translation, optical character recognition or other areas where access to a large amount of text is helpful, please contact us. We encourage the use of public domain materials for these purposes and may be able to help.
- + *Maintain attribution* The Google "watermark" you see on each file is essential for informing people about this project and helping them find additional materials through Google Book Search. Please do not remove it.
- + *Keep it legal* Whatever your use, remember that you are responsible for ensuring that what you are doing is legal. Do not assume that just because we believe a book is in the public domain for users in the United States, that the work is also in the public domain for users in other countries. Whether a book is still in copyright varies from country to country, and we can't offer guidance on whether any specific use of any specific book is allowed. Please do not assume that a book's appearance in Google Book Search means it can be used in any manner anywhere in the world. Copyright infringement liability can be quite severe.

About Google Book Search

Google's mission is to organize the world's information and to make it universally accessible and useful. Google Book Search helps readers discover the world's books while helping authors and publishers reach new audiences. You can search through the full text of this book on the web at <http://books.google.com/>

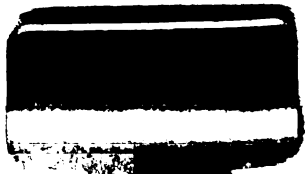





**REINFORCED CONCRETE
DESIGN**

REINFORCED CONCRETE DESIGN

BY

OSCAR FABER

B.Sc, A.M.I.C.E., A.M.I.E.E., A.C.G.I.

CHIEF ENGINEER TO MESSRS. TROLLOPE AND COLLS, LTD., LONDON

AND

P. G. BOWIE,

A.C.G.I.

ASSISTANT ENGINEER TO MESSRS. TROLLOPE AND COLLS, LTD., LONDON

ILLUSTRATED

NEW YORK
LONGMANS, GREEN & CO.

LONDON: EDWARD ARNOLD

1912

[All rights reserved]

TA 683
F2

TO VNU
ANNOUAD

PREFACE

THAT the technique of the art of designing reinforced concrete structures cannot be mastered solely by the study of books hardly needs to be emphasized, and no one realizes this fact more fully than the Authors of the present book. Coupled with study, practice under supervision is also essential. And this supervision may be of two kinds. There may be the constant vigilance of a master ready to indicate weak places, places where material has been wasted, and to suggest other designs which would be more generally suitable. The alternative is the supervision under which the pioneers conducted their practice, that is, directly under Dame Nature, who still has to be consulted from time to time. Weak places were found by collapses of test pieces or structures, places where material was wasted were indicated by a falling-off in clientèle, and a lack of success in competitive work.

Coupled, then, with practical work and experiment, upon which more is said in Chap. XIII., it is hoped that this work may prove helpful. A good deal of the matter is new, and several important considerations are taken into account which have hitherto been ignored, as far as the Authors are aware, in published literature on the subject. For example, it has long been realized that the bending moment for which beams should be designed cannot adequately be written down by any rigid formula, such as $\frac{wl^2}{12}$, as suggested by certain reports on reinforced concrete, but depends on such considerations as the ratio

of live to dead load, the relative stiffness of beams and columns, etc.; yet the present treatise is perhaps the first to subject these considerations to mathematical treatment and arrive at simple formulæ taking them into account. In the same way, it has been realized by some that columns are subjected to some bending action in addition to their direct load, owing to unequal loading of the floors. Some allowance is made for this in certain reports by specifying a lower stress in columns than in beams. It is shown in this book that this provision is in many cases utterly inadequate, while it is in a few cases excessive, and the mathematical investigations lead to comparatively simple formulæ, by which the stress due to bending may be calculated for any particular case. The question of resistance of beams to shear is also, among others, dealt with in a way which has far greater theoretical justification than commonly accepted methods.

But it is not claimed for the book that it obviates the necessity of the specialist. Because of the very great number of variables and the extraordinary choice of alternatives, the design of reinforced concrete is a hundred times more difficult than the design of steelwork, which commercial considerations have standardized to such an extent that the selection, for example, of a joist to do certain work may be made by reference to a table. With a concrete beam, you may use almost any depth and breadth you please, you may use a few large or many small bars, and no two designers will provide for shear, adhesion, etc., exactly alike. It is only, therefore, the fundamental considerations governing design that can be dealt with in a book, and we hope that our treatment will bring into prominence the principles underlying the practical design, which must remain more or less a compromise.

It is obvious that in practice many considerations must be considered which cannot be dealt with in a book of this kind, such as standardization of calculations and quantities, arrangements of reinforcement, and the many similar questions

which are essential to efficient, rapid, and reliable work, and are matters of importance to the engineering departments of large firms. Apart, however, from such questions of organization, an engineer will always require to be able to make accurate calculations, and it is hoped that this book may present the means to the solution of problems hitherto considered indeterminate.

The authors desire to record their indebtedness to Messrs. Taylor and Thompson for permission to reproduce Table IV., p. 104; to the Council of the R.I.B.A. for sanctioning the inclusion of the second report on Reinforced Concrete, as an appendix to this treatise; and to Prof. W. C. Unwin and W. Dunn, Esq., for allowing Appendices VII. and VIII. of that report to be given also.

OSCAR FABER.

P. G. BOWIE.

5, COLEMAN STREET, LONDON, E.C.,
February, 1912.

CONTENTS

	PAGE
PREFACE	v
NUMBERS OF PRINCIPAL FIGURES	xvii
LIST OF SYMBOLS	xviii

CHAPTER I

GENERAL PRINCIPLES

Properties of Concrete	1
Primary Object of Reinforcement	1
Examples of Concrete Structures	2
Advantages of Reinforced Concrete	2

MATERIALS

Steel	8
Patent Bars	10
Cement	12
Concrete	18
Sand	18
Aggregate	14
Proportions	16
Increase of Strength with Age	18
Consistency	18
Effect of alternate Wetting and Drying Cement Mortar	19
Effect of Variation of Stress on the Strength of Concrete and Steel	22

PART I

CALCULATION OF STRESSES UNDER KNOWN FORCES AND MOMENTS

CHAPTER II

SIMPLE BENDING AND SIMPLE COMPRESSION

Assumptions	25
Simple Bending	26

CONTENTS

	PAGE
T-Beams	38
Double Reinforcement	40
Simple Compression	44

CHAPTER III

BENDING COMBINED WITH DIRECT FORCES

Bending and Tension	47
Bending and Compression	61

CHAPTER IV

ADHESION AND SHEAR

Adhesion	71
Hooks and Bends	77
Shear in Beams	79
Shear in Slabs of T-Beams	90

PART II

THE DESIGN OF COLUMNS

CHAPTER V

STRENGTH OF COLUMNS

Difficulties in the Design	94
Short Columns	97
Value of Hooping and Binding	97
Eccentric Loading	109
Long Columns	110
Splices in Columns	118

CONTENTS

xi

CHAPTER VI

THE DETERMINATION OF THE DIRECT LOADS ON COLUMNS

	PAGE
Two Spans	116
Three Spans	117
Four or more Spans	120

CHAPTER VII

THE DETERMINATION OF THE ECCENTRIC STRESSES IN COLUMNS

Interior Columns	
Two Spans	123
Three Spans	136
Four or more Spans	141
Outside Columns	
One Span	143
Two Spans	151
Three or more Spans	152
Value of the Eccentricity	153

PART III

THE DESIGN OF BEAMS AND SLABS

CHAPTER VIII

BEAMS

Shearing Forces	156
Bending Moments under Different Conditions of Loading	157
Variation of Size of Beams	172
General Considerations	179
Effect of Settlement of Supports	181
Bent Beams	183
Lintels	186

CHAPTER IX

SLABS

	PAGE
Bending Moments	188
Effect of the Deflection of the Supporting Beams	198
Shearing Forces and Adhesion	198

PART IV

APPLICATIONS AND GENERAL NOTES

CHAPTER X

RESERVOIRS

Stresses	201
Reservoirs below Ground	208
Circular Reservoirs	205
Rectangular Reservoirs; Bending Moments	210
Water Towers	212
Wind Moments	213

CHAPTER XI

RETAINING WALLS

Earth Pressures	219
Types and Proportions	223
Factor of Safety	224

CHAPTER XII

SPECIFICATIONS

General	238
Variations	238
Foundations	238
Column Loads	234
Floor Loads	234

CONTENTS

xiii

	PAGE
Test Loads	235
Materials	237
Finish	237
Centering	238
Vibration	239
Camber	239
Inspection	240
Wiring Bars	240
Leaving Holes	240
Maximum Depth of Beams	241
Maximum Size of Columns	241
Plain Concrete under Footings	241
Test Blocks	241
Fire-resisting Constructions	242

CHAPTER XIII

QUANTITIES AND NOTES ON PRACTICAL APPLICATIONS

Quantities	245
Additional Notes on Applications of Reinforced Concrete	
Use of Brick and Concrete Supports	247
Foundation Rafts.	247
Piles	248
Concrete Chimneys	249
Notes for Students and the Need for Experimental Study	253
Electrolytic Corrosion of Reinforcements	254

CHAPTER XIV

THE SPECIALIST ENGINEER, AND THE CONTRACTOR

The Specialist Engineer	256
The Contractor	258

APPENDIX I

BEING MATHEMATICAL ANALYSES OF BEAMS UNDER
VARIOUS CONDITIONS OF LOADING AND FIXING

NO.	SUBJECT	PAGE
	LIST OF SYMBOLS	262

ONE SPAN

1	Uniform load, slope at the ends given	268
2	Load uniformly varying from zero at the ends to a maximum at the centre, slope at the ends given	266
3	Concentrated load at midspan, slope at the ends given	267
4	Two concentrated loads at the third points, slope at the ends given	270
5	Uniform load, beam monolithic with columns	278

TWO SPANS

6	Uniform load, beam not monolithic with columns	278
7	Uniform load, beam monolithic with columns	274

THREE SPANS

8	Uniform load, beam monolithic with columns	277
---	--	-----

GENERAL CASE

9	Any number of spans, uniform loads, spans and loads on different spans not necessarily equal	280
---	--	-----

INTERIOR BAY OF BEAM OF MANY SPANS

UNIFORMLY DISTRIBUTED LOAD

10	Maximum moment at the centre	288
11	Maximum moment at the supports	284

LOAD UNIFORMLY VARYING FROM ZERO AT THE ENDS TO A MAXIMUM
AT THE CENTRE

12	Maximum moment at the centre	286
13	Maximum moment at the supports	287

CONTENTS

XV

NO.	SUBJECT	PAGE
	CONCENTRATED LOAD AT MIDSPAN	
14	Maximum moment at the centre	288
15	Maximum moment at the supports	289
	TWO CONCENTRATED LOADS AT THIRD POINTS	
16	Maximum moment at the centre	291
17	Maximum moment at the supports	292
18	BEAMS UNDER A LOAD UNIFORMLY VARYING FROM ZERO AT ONE END TO A MAXIMUM AT THE OTHER	298
	EFFECT OF SETTLEMENT OF SUPPORTS ON THE CENTRE MOMENTS OF CONTINUOUS BEAMS	
19	Many Spans	296
20	Two Spans	298

APPENDIX II

SECOND REPORT OF THE R.I.B.A. ON REINFORCED CONCRETE (1911)

Notation	301
Prefatory note	304
Fire resistance	305
Materials	306
Methods of calculation	310
Shear reinforcement	315
Pillars and pieces under direct thrust	317
Pillars eccentrically loaded	321
Long pillars	323
Appendix VII., Bach's theory of slabs	324
Appendix VIII., strength of slabs	326
INDEX	329

PRINCIPAL FIGURE NUMBERS

FIG.	SUBJECT	PAGE
2	Typical Reinforcement for a Continuous Beam	6
6	Variations of strength of concrete with age	17
10	Relation between p and n_1	28
11	„ „ t_1 „ n_1	30
12	„ „ p „ t_1	32
13	„ „ p „ a_1	38
14	„ „ t_1 „ a_1	35
16	„ „ p „ R/bd^2	37
23	„ „ $t_1, p,$ „ $\frac{e-f}{d}$ ($m = 15$)	50
24	„ „ $t_1, p,$ „ $\frac{e-f}{d}$ ($m = 10$)	51
32	„ „ $t_1, p,$ „ $\frac{e+f}{d}$ ($m = 15$)	65
33	„ „ $t_1, p,$ „ $\frac{e+f}{d}$ ($m = 10$)	66
70	Values of constant K in the equation $M = KCE\alpha$ for columns	125
82	Values of the bending moment on exterior columns	154
84 } 85 } 86 }	Values of the bending moments due to dead and live loads on beams of two, three, and four spans.	<div style="display: flex; align-items: center; justify-content: center;"> <div style="font-size: 3em; margin-right: 5px;">}</div> <div style="text-align: left;"> <div style="margin-bottom: 5px;">158</div> <div style="margin-bottom: 5px;">159</div> <div style="margin-bottom: 5px;">160</div> </div> </div>
99	Typical reinforcement to the junction of a beam to an outside column	171

LIST OF SYMBOLS

LENGTHS, DISTANCES, INTENSITY OF LOADS, STRESSES PER UNIT OF AREA, AND CONSTANTS

- a* Arm of the couple formed by the compressive and tensile forces in a beam.
- a*, Ratio a/d .
- b* Breadth of a rectangular beam.
- b_r* Breadth of the rib in a T-beam.
- b_e* Effective breadth of the slab in a T-beam.
- c* Compressive stress intensity.
- c*. Compressive stress intensity on concrete.
- c_s* Compressive stress intensity on steel.
- d* Effective depth of a beam from top of beam to axis of tensile reinforcements.
- d_t* Total depth.
- d_s* Total depth of a slab in a T-beam.
- d_c* Depth or distance of the centre of compressive reinforcement from the compressed edge.
- δ* Deflection of a beam.
- e* Eccentricity of any load.
- f* Friction or adhesion between surfaces in units of force per unit of area.
- h* Height.
- l* Length.
- l* Effective length or span of a beam or arch.
- m* Modular ratio, i.e. the ratio between the elastic moduli of steel and concrete = E_s/E_c .
- n* In beams: distance of the neutral axis from the compressed edge of a beam.
- n_s* The ratio n/d , i.e. the distance between the neutral axis and the compressed edge divided by the effective depth of a beam.
- p* Percentage of steel, i.e. $p = 100r$.
- p* Intensity of pressure per unit of length or area in any direction.
- r* Radius.
- r* Ratio of area of steel to area of concrete in single reinforced beams (compare *p*).
- t* Tensile stress intensity.

- t , Ratio of stresses = t/c .
 w Weight per unit of length.
 w Weight per unit of volume.
 x Horizontal co-ordinate of a point.
 y Vertical co-ordinate of a point.

AREAS, VOLUMES, MOMENTS, TOTAL LOADS, TOTAL FORCES,
AND CONSTANTS

- A Total cross-sectional area of a pillar.
 A_L Cross-sectional area of longitudinal steel rods in a pillar.
 A_E Equivalent area.
 A_c Area of compressive reinforcement in beams.
 A_T Area of tensile reinforcement in beams.
B Ratio I/l for beams, *i.e.* a measure of stiffness.
C Ratio I/l for columns, *i.e.* a measure of stiffness.
E Elastic modulus of any material.
 E_c Elastic modulus of concrete in compression.
 E_s Elastic modulus of steel.
F Total friction between any two surfaces.
I Inertia moment.
K A constant in the equation $M = KEC\alpha$ (see Appendix I. 1).
M Bending moment.
P Total pressure on a given area.
R Resistance moment of the internal stresses in a beam at a given cross-section.
R Reaction of a beam on its support.
S Total shearing force across a section.
T Total tensile force.
W Weight or load.

ANGLES, CONSTANTS, AND MISCELLANEOUS

- α Slope of a beam or column at the end produced by bending.
 θ An angle.
 μ Coefficient of friction.

UNIVERSITY OF
TORONTO LIBRARY

REINFORCED CONCRETE DESIGN

CHAPTER I

GENERAL PRINCIPLES

BEFORE going deeply into any part of the subject, a general reconnaissance of the field to be covered will be made.

Concrete is a mixture of cement, sand, and stone, which is wetted until it forms a plastic mass that will take the shape of any mould in which it is placed and tamped. The usual proportions are approximately 4 parts of stone, 2 parts of sand, and 1 part of cement, measured by volume, though these proportions are not to be adhered to in all cases. Such a concrete will set under favourable conditions, and will gradually harden with age, producing a mass resembling stone in many of its properties.

The most important property of concrete which underlies the desirability of reinforcing it at all, is the fact that its tensile strength is only a fraction (approximately one-tenth) of its compressive strength. Its tensile strength, besides being low, is also very unreliable, since it may be entirely lost by a sudden jar, by vibration, or by the contraction produced either in setting and drying or during a fall of temperature. For this reason concrete unreinforced can only be used under such conditions that no tensile stresses are produced in it. This is a very serious limitation, which precludes its use in any form of beam or girder, and practically limits its application to arches, piers, and such massive constructions as solid dams and retaining walls.

The primary object of reinforcing concrete is to remove this limitation, and the great success which has attended the

scientific achievement of this object has widened the field for which concrete is suitable to such a remarkable extent that there are now few engineering structures in which it may not, with advantage, be substituted for steel or timber. The mere enumeration of a few such examples, which could be largely multiplied, will bear out this statement:—

Large buildings of all kinds complete, including floors, beams, girders, stanchions, footings, and walls.

Bridges, whether of the arch or girder type.

Retaining walls of very thin and economical section.

Water towers, including the tank, columns, bracing, etc.

Wharves and piers, including piles, columns, bracing, decking, etc.

Self-supporting chimneys of very light construction, in which the necessary stability is not produced by the weight of the superstructure.

In all these and many other types of structures, reinforced concrete has, in numerous cases, shown itself to possess a combination of the following advantages over the material which was formerly more usual:—

Resistance to fire.

Resistance to rot and to the attack of pests, such as the *Teredo navalis* in marine structures, and the white ant and such vermin above ground. In some cases *Homo humanus* might justly be included in this list, as he not infrequently plays havoc with any removable timber.

Resistance to air and water without requiring painting or other upkeep.

Increase of strength with age.

Reduced first cost.

The authors only claim the above properties for the material when proper precautions are taken in the design and execution, and the claim of reduced first cost cannot be made in all cases. It may be taken as granted, however, in this age of commercialism, that where it has been adopted, it has always had a reduced *ultimate* cost, when its absence of upkeep and other properties are taken into account. It is not now the custom to erect a structure in the best possible material as well as we know how, simply for the joy of doing a thing supremely well

—this belonged to the old-world civilization of Greece, and is, unfortunately, foreign to us.

To supply the requisite tensile strength to our material, steel bars are embedded in the concrete where tensile stresses are anticipated, for instance, at the underside of a freely supported beam. If this is done consistently, we have, qualitatively, the key to the greater portion of reinforced concrete design, and it merely remains to calculate, from ordinary scientific principles, the quantity of such reinforcement required. It should be noted, however, that the mere embedding of steel bars in the concrete would not produce a reliable composite material, except for two extremely fortunate circumstances, which were probably not realized by the pioneers of its use. The first is the fact that concrete contracts slightly during setting in air, and, in contracting round a steel bar, holds it tightly in such a way as to prevent the steel from slipping even when no hooks or even roughnesses exist on the bar. The second is the fact that steel and concrete have practically identical coefficients of expansion, and consequently a uniform change of temperature does not involve temperature stresses in the two component materials.

When what may be termed the flange stresses due to bending moments have been guarded against by reinforcing as suggested, it will be found that the safe load on a member of a given size has been so largely increased that secondary stresses due to shear rise to importance, and may produce failure unless the concrete is reinforced with reference to them also. Consider, for instance, a beam supported at the ends as in Fig. 1. If unreinforced, fracture will occur as in 1 (*a*), by the concrete failing under the tension flange stress due to the bending moment. This may be prevented by adequately reinforcing as in 1 (*b*).

If the safe load is increased in this way up to a certain point, the tensile stress developed across oblique planes near the ends will cause failure, as in 1 (*c*). This may be prevented by adequately reinforcing across such planes by bending up some of the bars near the ends as 1 (*d*), by providing vertical reinforcement—generally called stirrups—as at 1 (*e*), or by a combination of these methods.

When a beam is continuous over several supports, as it generally is, it may be designed in one of two ways:—

(a) As a continuous beam, in which tension will exist at the top of the beam near the supports, and will necessitate suitable reinforcement to take up this tension.

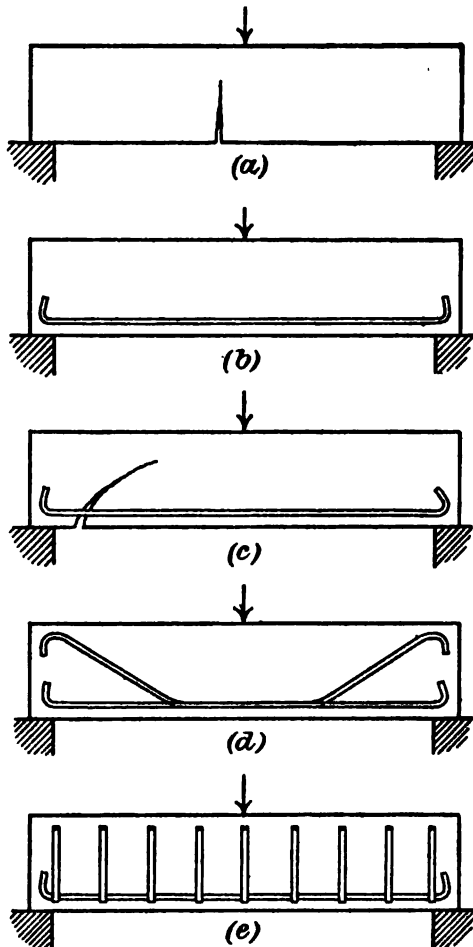

FIG. 1.—Stages in development of beam reinforcement.

(b) As a series of non-continuous beams, in which the negative bending moment at the point of support is neglected in the calculations.

In the latter case, owing to the inability of concrete to resist tensile stresses, a crack will be formed at the top of the beam at the point of support.

The relative merit of these two methods depends on the circumstances of any particular case, (*b*) being almost invariably adopted in steelwork designs, and being desirable in reinforced concrete when there is a possibility of the supports subsiding unequally. The method (*a*) is generally more economical of materials, and is therefore adopted whenever permissible, and even in cases when the authors would consider the other method the safer.

Under case (*a*) it is found a suitable and economical arrangement to combine in the bent-up bars the provision for shear and for negative bending over the support, as is done in Fig. 2, which shows a typical beam reinforced for continuity. It must be noted at once that the design of a continuous beam is not a simple matter, since many conditions of loading have to be considered.

When the central bay in Fig. 2 is fully loaded, the bars *a* and *b* may be sufficient to provide for all tensile stresses due to bending moments, but the case has also, in general, to be considered when the bays to the left and to the right are fully loaded, and the central bay in Fig. 2 is unloaded. In that case a little consideration will show that tension may occur at the top of the beam instead of at the bottom, the bars *c* being required to resist such stresses. As the amount of the negative bending moment causing tension at the top of the beam near midspan will be counteracted by the dead weight of the floor, it is obvious that the design of the bars *c* is not simple. They are advisable even when tension at the top is not anticipated near midspan, since they are very convenient for fixing the main bars and stirrups while concreting, and give a good connection to the upper ends of the stirrups, which is extremely important, as will be shown later (p. 86).

The design of continuous beams will be fully treated in Chap. VIII.

If we follow out rigidly the principle that reinforcement is primarily required to increase the tensile strength of the material, it is obvious that columns, axially loaded, do not

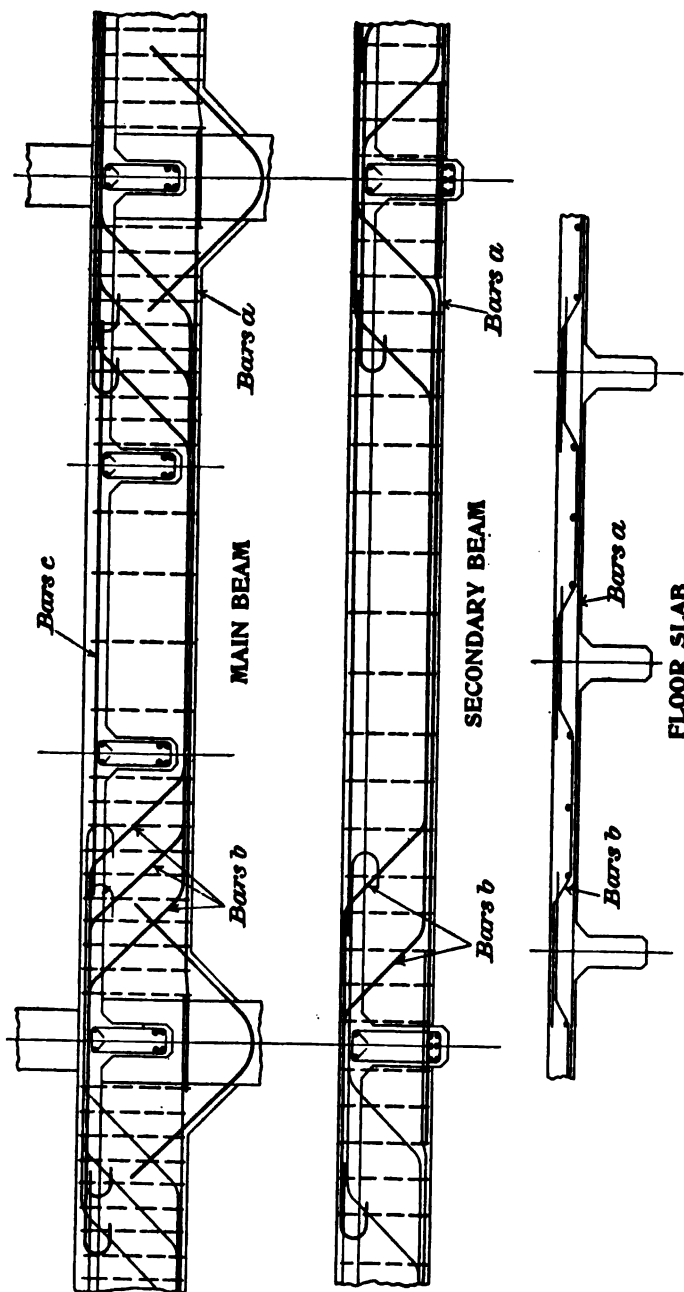

FIG. 2.—Typical arrangement of reinforcement in a continuous beam.

require reinforcing, and the authors are of opinion that cases sometimes occur when the reinforcement in a column does not add appreciably to its strength.

More generally, however, the column is rigidly connected to beams, which may be unequally loaded in such a way as to load the column eccentrically, and in such cases longitudinal steel may be necessary to resist the tensile stresses produced at one side. Obviously, too, a column with longitudinal reinforcement is much better able to withstand shock or accidental side thrust.

It is also found that the columns in the lower tiers of a building of many floors are frequently called upon to carry heavy loads, and would require to be of large section if the concrete were relied upon to carry all the load. In cases where for satisfactory architectural treatment or from other considerations such large columns would be objectionable, it becomes necessary to reinforce them to render a smaller section capable of carrying the load. This may be done by one of two methods—

(a) By using a very high percentage of longitudinal steel.

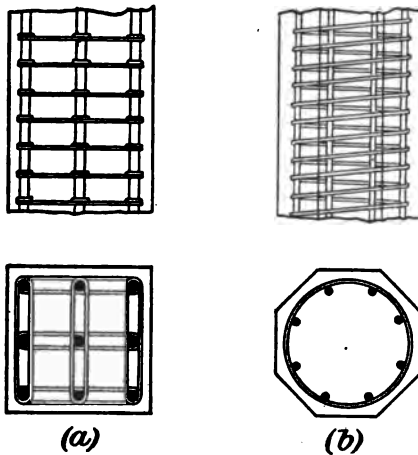

FIG. 3.—Reinforcement for columns.

This must, however, be bound together at short intervals by adequate binding, or links, since otherwise the column fails by

the bars buckling individually and bursting the column. Fig. 3 (a) shows such a column.

(b) By providing a spiral binding round the column, designed with a view to preventing the lateral dilatation of the concrete under vertical compression. It is found that such a spiral increases very considerably the compressive stress which the concrete will sustain without failure. A certain amount of vertical steel is invariably used in addition to the spiral, and serves to prevent the concrete from bulging out between two successive spirals, and also to take up any possible tensile stresses due to eccentric loading and accidental shock or side thrust. Such a column is shown in Fig. 3 (b). It is generally made of circular or octagonal section. The concrete outside the spiral is not taken into account in calculating the resistance of the column, as it flakes off long before the ultimate load is reached, and consequently any concrete outside the spiral should be reduced to a minimum consistent with efficient fire protection.

The strength of columns is discussed in Chapter V.

MATERIALS.

STEEL.

The properties of steel are so well known that it is not necessary to give them more than a cursory glance.

The most commonly used material, at any rate in Europe, is commercial mild steel. This should have an ultimate strength of not less than 60,000 lbs./ins.², an elastic limit not less than 32,000 lbs./ins.², and a minimum elongation of 22 per cent. in a gauge length of 8 diameters, or 27 per cent. in a gauge length of 4 diameters. The steel should be able to withstand bending cold round its own diameter without signs of fracture. Such mild steel may without damage be bent cold to the shapes required for concrete work.

The safe tensile stress on such steel is generally taken as 16,000 lbs./ins.²*

* When, however, the stress is subject to considerable variation or reversal, it may be desirable to reduce this. See p. 22.

In reinforced concrete members, it is found that when the yield point of the steel is reached, the extension becomes so great as to cause very large cracks, which, apart from their unsightliness, expose the reinforcement to corrosion. In the case of beams this increased extension of the tension members causes the neutral axis to rise towards the compression side, and by reducing the area in compression greatly increases the compressive stress. It is therefore found that in the case of beams in which the steel is well proportioned to the concrete, failure by compression of concrete occurs when the yield point of the tensile steel is reached.

For these reasons, the elastic limit of the steel is frequently a more important property than the ultimate strength, and the factor of safety should be stated in terms of the elastic limit rather than in terms of the ultimate strength. It will be seen from this that for a steel with an elastic limit of 32,000 and a working stress of 16,000 the real factor of safety is only 2, and not 4 as generally stated. If the factor of safety is defined to be the ratio of the ultimate stress to the working stress *of the material*, then it is no guide as to how much the structure may be overloaded without failure.

The same holds good for steel work structures. If a lattice girder with riveted joints be designed for a stress of 16,000, and be built with a material having a yield point of 32,000 and an ultimate stress of 64,000, it will be found that if tested to destruction, the factor of safety of the structure will not much exceed 2. The reason for this is that when once the yield point is reached, the deformations are so great that high secondary stresses are produced at the joints. Recent experiments on built-up steel compression members also show that failures occur when the yield point is reached. In either case, however, the deflection of the girder is quite in excess of anything which could be tolerated in practice.

In view of this importance of the elastic limit, some firms, particularly in America, use a steel having a much higher elastic limit than commercial mild steel. This is generally produced by increasing the percentage of carbon in the steel. It may, however, also be produced by overstraining mild steel. Thus in the production of wire, expanded metal and of twisted

steel, the elastic limit and ultimate strength are increased considerably. This increase is, however, always obtained at the expense of the ductility, and a more brittle material is obtained.

For example, the American Society for Testing Materials issued recommendations in July, 1911, for mild steel and hard steel, both intended for reinforcements. The bending test for the former was to be round the diameter of the bar, while for the latter round three diameters for plain bars, and four diameters for deformed bars. This is sufficient indication of the increased brittleness of such steel. There would also seem to be some doubt as to whether this raised elastic limit is permanent, and whether it may not be reduced by vibration and shock.*

In any particular case it has to be considered whether this greater brittleness is dangerous or not, which will depend on the nature of the bending required, and to some extent on the climate, as bars break much more readily in frosty weather. In all the examples in this book the use of mild steel will be assumed, and the working stress of 16,000 will not be exceeded.

The coefficient of elasticity of steel is 30×10^6 lbs./ins.², and the coefficient of expansion with temperature is 0.000012 per 1° C. or 0.0000066 per 1° F.

The most usual section of bar is the round rod. These generally vary from $\frac{5}{8}$ in. to $\frac{3}{4}$ in. diameter in slabs, and $\frac{3}{4}$ in. to $1\frac{1}{2}$ ins. diameter in beams.

Although loose scale on the bars is dangerous and should be scraped off, a thin covering of rust is not a disadvantage, as the roughness of the surface increases the adhesion between the steel and the concrete.

Many patent bars for reinforcement are on the market, the object being generally one of the following:—

(1) To increase the adhesion between the steel and concrete, by providing projecting ribs on the bar, or sinking depressions into it. The better known of these are the Indented Bar and the Twisted bar (Fig. 4).

It has to be considered in any case whether the requisite adhesion cannot be obtained with plain round bars.

Some of these patent bars have practical objections which partly offset the advantages which their use is intended to confer.

* See Unwin, *Testing of Materials*, pp. 362 et seq.

One of these is the greater difficulty of getting concrete to fill every crevice between the bars (which applies also to some of the bars in (2)) and another is the difficulty experienced in sliding links in a column down the bars. With deformed bars

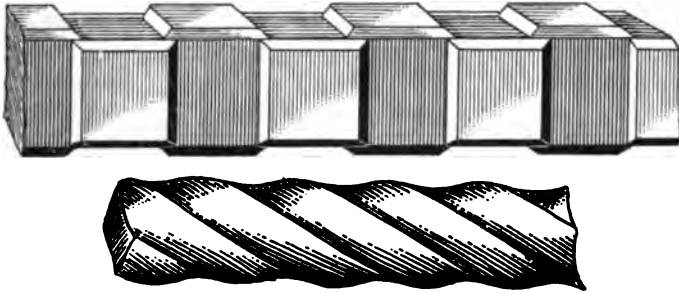

FIG. 4.—Types of patent bars designed to give increased adhesion.

the links are frequently made looser than is required, so as to enable them to pass over the projections, but such loose links are not desirable.

(2) To provide special connections between the stirrups and the main bars.

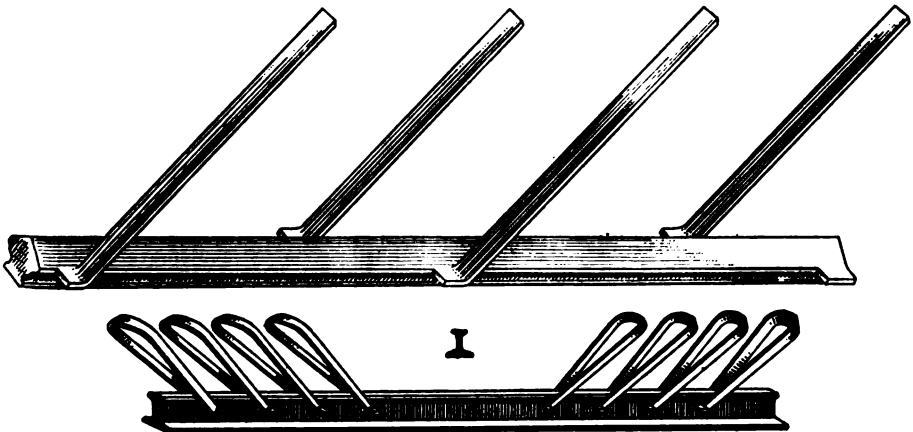

FIG. 5.—Types of patent bars designed to give increased shear resistance.

The best known of such bars is the Kahn; in this the bar is made of a square section with two longitudinal projections,

which are sheared and bent up at an angle of about 45° (Fig. 5).

In the Pohlman bar a joist section is used, the shear members consisting of hoops connected to the joist by a key fastening through holes in the web.

In any particular case it has to be considered whether these patent bars provide a better shear reinforcement than is obtained by bending up part of the tension reinforcement towards the ends of the beam, and using ordinary stirrups.

Throughout the examples in this book the use of ordinary commercial sections will be assumed.

CEMENT.

Since in reinforced concrete the strength of the concrete can generally be fully utilized, it is important to use the very best cement obtainable. The difference in price between the best and the worst cements is so small as to be negligible in comparison with the difference in the strength and reliability of the concrete.

The British Standard Specification 1910 should be insisted upon in every particular. As, however, there is no difficulty in obtaining a cement of considerably greater strength than this specification requires, it is recommended that the tensile stresses called for should be increased by 100 lbs./ins.² in the case of neat cement, and 40 lbs./ins.² in the case of 3 to 1 standard sand briquettes.

For all reinforced concrete work slow-setting cement should be used except in special cases. It is of the utmost importance that no concrete be disturbed or subjected to vibration after setting has begun. In connection with the use of quick-setting cement, it should be remembered that the "quickness" applies generally to the setting only and not to the hardening, a concrete made with slow-setting cement having generally the same strength in a day or two as one made with quick-setting cement. Rotary cement generally attains its strength more quickly than the older non-rotary cement.

CONCRETE.

To produce the best possible concrete with any given materials is a separate science with an extensive bibliography of its own, which lies outside the scope of this treatise, and to which the reader is referred.* Only a few salient points will be touched upon.

It may be stated at once that the choice and correct proportioning of the sand and stone are of such paramount importance that, with the same proportion of cement, a difference of 100 per cent. may easily occur between the strength of a good and a bad concrete.

Sand is defined, for convenience, as those particles of a ballast—which may be either gravel or broken stone—which pass through a sieve having $\frac{1}{4}$ in. mesh.

1. The particles should be well graded, that is, there should be particles of all sizes, from $\frac{1}{4}$ in. diameter to the very finest grains. Very frequently it is found that sands are deficient in particles having diameters varying between $\frac{1}{4}$ in. and $\frac{1}{8}$ in. The strength is greatly increased if this deficiency can be made up.

2. There must not be any excessive proportion of very small particles. For example, "silver sand" is generally much too fine to make a strong mortar without using a large proportion of cement.

Cement has to be added to sand in sufficient proportion to cement the particles of sand to one another and to the surrounding aggregate. This necessitates the covering of all surfaces by cement, and hence the smaller the particles of sand and aggregate, the greater the proportion of cement which has to be added to obtain the same strength, and similarly a greater amount of water has to be added to obtain the same consistency.

3. The sand must be clean, *i.e.* free from loam or clay, and above all from any vegetable or organic impurity. A rough test may be made by rubbing some moist sand on the palm of

* See, for instance, Taylor and Thompson's *Concrete Plain and Reinforced*. Also *Chimie Appliquée*, 1897, by M. Feret.

the hand, when no brown stain should be left. A better test is to stir a little sand up with water in a tumbler, when the sand will settle immediately, and the clay very slowly; the percentage will thence be apparent. Certainly the thickness of the clay layer must not exceed $\frac{1}{8}$ in. where the layer of sand is 2 ins. thick.*

When any doubt exists as to a sand being sufficiently free from loam, it should be washed, but in such a way as not to lose the fine particles. In many sands a small percentage of loam increases both the density, watertightness, and strength of the concrete.

Certain tests would seem to indicate that organic impurities are particularly harmful. A case is quoted by Taylor and Thompson † in which 0.5 per cent. of organic impurity in sand reduced the tensile strength from 201 to 93 lbs./ins.² at a month for a 1 to 3 mortar.

Shells should also be avoided, though dredged material frequently contains this impurity. As an empty shell will generally not be filled with concrete, it forms a bad void.

4. The sand should be sharp, in preference to rounded. It is sometimes thought that pit sand is sharper than dredged material (such as Thames ballast), or sand from the shore. There does not, however, appear to be any geological reason for this, and as a matter of fact it depends entirely on the individual pit.

Aggregate.—The aggregate generally consists of broken stone or ballast. The smallest particle must not pass through a $\frac{1}{4}$ in. mesh. The largest particles must be less than the minimum clearance between the bars and the centering, or between the individual bars, as there may otherwise be difficulty in getting the concrete to fill every space in the centering. Three-quarters of an inch is frequently considered a maximum for beams, and $\frac{1}{2}$ in. for slabs and thin walls. In very heavy work, however, the size may be increased with advantage, since it is found that with good grading the strength of the concrete increases with the size of the largest particles.

* This does not mean that the loam will be $6\frac{1}{2}$ per cent. of the sand, since the loam in the glass will be much less compact than the sand.

† *Concrete Plain and Reinforced*, p. 154b.

1. The particles should be well graded (as for sand).

2. The particles should be sharp rather than rounded. Thus crushed Thames ballast gives better results than rounded pebbles when the concrete is only about a month old, but the difference in strength diminishes with increasing age. Generally, however, the strength in a month or two is the critical value which matters most.

3. The surface should be rough rather than smooth. Thus granite gives much higher strength than flint.

4. The strength of the stone should be high. Thus brick concrete is generally greatly inferior to stone or ballast concrete.

A fracture through a specimen of brick concrete generally cuts through as many bricks as possible, whereas in stone concrete, the fracture generally occurs in the mortar forming the joints between the stones. When this is so, it indicates that the strength of the bricks is less than that of the mortar, while that of the stone is more. It has also to be considered whether the brick does not absorb part of the cement with the large quantities of water which are certainly absorbed.

5. The stone should be quite free from sulphur or any other substance which may in combination with atmospheric constituents cause corrosion of the steel, or its own disintegration. For this reason a silicious stone is to be preferred to a limestone, though the latter is very largely used in America. Cinder concrete is dangerous, since a small percentage of sulphur is generally to be found in it, and may cause considerable expansion of the concrete. Further, the strength of cinder concrete is generally insufficient. Cinder concrete does, however, form a better fire-resisting material than the concrete made from ballast, as the flints are liable to burst in the heat; and, further, nails may be driven into cinder concrete and not into ballast concrete.

Cinders are to be distinguished from coke breeze, which frequently contains a large proportion of unburnt coke or coal. This proportion is often so great that when subjected to an intense heat, a concrete made from it will slowly burn through and be destroyed. Such a concrete cannot be called fire-resistant, and should therefore not be used, as it has neither

the high strength of ballast concrete nor the fire-resisting qualities of cinder concrete.

For these reasons, a fire-proofing layer of cinder concrete round the ballast concrete used for structural purposes makes a well-protected and convenient structure where the cost may be incurred.

The nature of the stone used in the concrete should certainly be taken into consideration in determining the permissible stress.

When the aggregate and sand have been selected, they are to be proportioned in such a way as to form the mixture which gives the minimum voids, that is, the densest mixture. This can be calculated from the percentage of voids in the sand and ballast. A good method is to make a few trial mixtures and find the voids in each. Thus one part of sand may be mixed with $1\frac{1}{2}$, 2, and $2\frac{1}{4}$ parts of stone, and a vessel of about 3 cubic feet contents, having a depth of about twice its diameter, may be filled with each mixture in turn. If the voids are then filled with water, and the quantity of water required in each case measured, the mixture requiring the addition of least water is the densest of the three. If instead of filling the voids with water the three measures are weighed, the heaviest will be that containing the densest mixture. Generally about twice as much stone is required as sand for the best mixture.

The quantity of cement must be sufficient to fill all interstices, and to form an adhesive material between all particles. Hence the importance of fine grading, so that as little cement as possible is wasted in filling the voids, which are as well filled with pieces of sand or stone.

The cement should not have a volume less than one half of the sand, and more may be desirable.

A common concrete is 1 part cement, 2 parts sand, and 4 parts stone, generally referred to as 1 : 2 : 4 concrete, all measurements being by volume and not by weight, unless specially referred to as being by weight.*

It may be desirable to measure the cement by weight,

* In this connection it may be mentioned that laboratory tests are frequently proportioned by weight, and concrete in practice by volume, which causes a discrepancy that must be guarded against.

i.e. from the number of sacks—and for purposes of calculating proportions one cubic foot of cement may be taken to weigh 90 lbs.

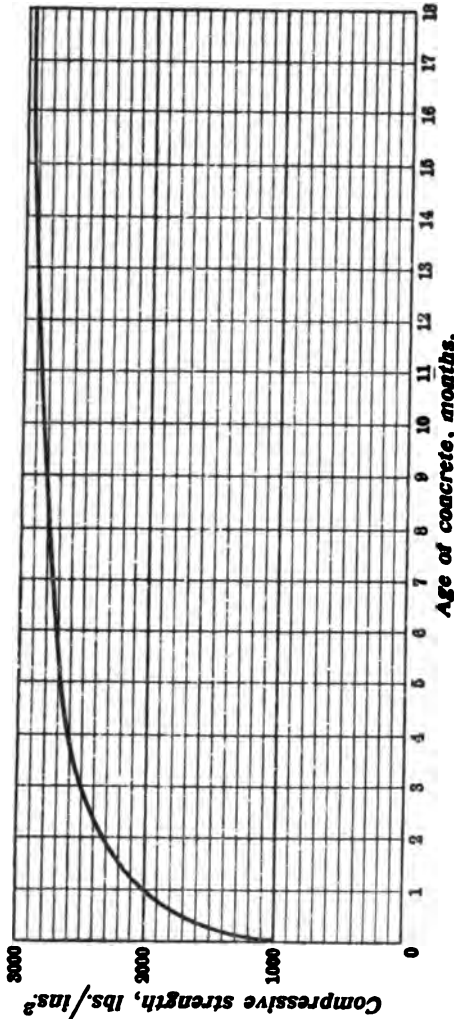

FIG. 6.—Curve showing the crease in the compressive strength of concrete with age.

In consequence of the voids in the ballast being filled by sand, and the voids in the sand being filled by cement, it is obvious that a considerable reduction in volume takes place

when the three materials, ballast, sand, and cement, are mixed. With average materials owing to this reduction in volume approximately 23 cub. ft. ballast, $11\frac{1}{2}$ cub. ft. sand, and about 6 cwt. cement (depending on the strength of concrete required) are necessary to make 1 cub. yd. of concrete. Varying the amount of cement within limits does not appreciably affect the volume of finished concrete.

For water-tanks and other places where watertightness is particularly required, the quantity of cement may be increased with advantage, a $1 : 1\frac{1}{2} : 3$ concrete generally being good.

The ultimate strength of $1 : 2 : 4$ concrete, using good materials and well-graded broken stone as the aggregate, is generally about 2000 lbs./in.² at one month, and about 2700 lbs./in.² at six months. There is no particular object in giving elaborate tables or curves for the strength of concretes of various proportions or ages, since very great variations are produced by differences in either the cement, sand, stone, temperature, percentage of water, quality of mixing, etc. The usual working stress for good concrete is 600 lbs./ins.²*

The variation in the strength of concrete with age follows approximately the curve in Fig. 6.

Wet and Dry Concrete.

Considerable difference of opinion exists among experts as to how wet a concrete should be for the best results.

Tests of laboratory specimens, in which the concrete can be rammed very hard, show that a dry concrete gives the best results. In practical reinforced concrete work this cannot be done, since generally the centering will not sustain the necessary pressure, and the stirrups and bars make it practically impossible to effect hard ramming. For this reason the laboratory tests referred to are of little value, and there is no reason to suppose that a dry concrete is stronger than a wet one *when not rammed hard*.

In practical work it is necessary for the concrete to be of such a consistency that every crevice will be filled, including

* Where the stress is subject to considerable variation or reversal, it may be desirable to reduce this (see p. 22).

the space under and between the bars. To secure this there is no doubt that a fairly wet concrete is best. As this also gives a good face and makes a dense and waterproof concrete, the authors consider it best.

The limit on the wet side is reached when the cement grout comes to the surface and runs away, in which case, of course, the concrete is correspondingly impoverished. It is not easy to give an accurate idea of what constitutes a wet or dry concrete.* The percentage of water cannot be specified on the works, since the amount of water in the sand is considerable, and varies greatly with the weather. It is found in practice that it is best to show a foreman a sample of concrete correctly mixed, and get him to work to it by eye, in which case he will take such variations of the material into account. Perhaps the following gives as good an idea as can be given in writing:—
“The concrete shall have only so much water as is necessary to make it flow to a level surface when well worked.”

Even with a wet concrete, it is necessary to work † it considerably, to give air-bubbles a chance to escape to the top. Where a good face is required, it is a good plan to strike the sides of the moulds with a hammer, which often releases bubbles from the sides.

THE EFFECT OF ALTERNATE WETTING AND DRYING ON THE STRENGTH OF CONCRETE.

A property of concrete which appears to be generally unknown is the effect on its strength of immersing it in water, and of drying a specimen previously immersed. As this condition is frequently obtained in practice and the effects are very marked, they will be given here. Forty-five tension specimens of a mixture of 3 parts standard sand and 1 part cement were kept in air one day and in water for twenty-seven days. All the specimens were then allowed to dry, and were

* This may be inferred from the descriptions given by some authorities, such as “neither too wet nor too dry.”

† It is a mistake to speak of ramming concrete of the best consistency for reinforced work, since it should be too wet to ram, and should give way before the tool.

tested, five at a time, after periods of drying, with the following results * :—

Drying time.			Mean tensile strength.
—	497 lbs./ins. ²
6 hours	558 "
14 "	462 "
24 "	879 "
2 days	810 "
3 "	858 "
4 "	408 "
6 "	495 "
12 "	622 "

These results are plotted in Fig. 7.

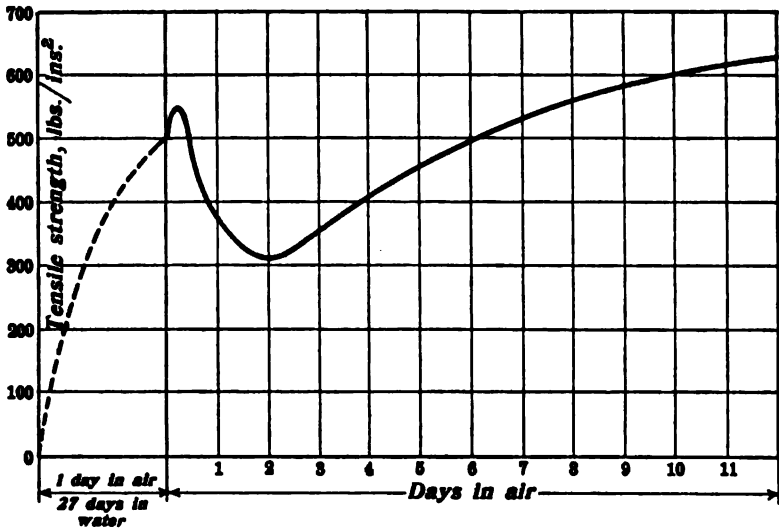

FIG. 7.—Curve showing effect of drying a specimen of concrete previously immersed.

Similar tests were made in which the specimens were kept moist for one day, under water seven days, and then in air. At the age of twenty-eight days all the specimens were immersed, and tested, five at a time, after the following periods of immersion :—

* *Mitteilungen über Forschungsarbeiten, Verein deutscher Ingenieure, Heft 72-74, S. 104 u. f.*

Time of immersion.			Tensile strength.
—	702 lbs./ins. ²
3 hours	386 "
6 "	357 "
9 "	346 "
24 "	378 "
2 days	408 "
8 "	449 "
7 "	456 "
14 "	484 "

It will be seen from Figs. 7 and 8 that the effect of wetting and drying is very great indeed.* The cause is no doubt to be found in the expansion and contraction which occur during such changes, and the consequent stresses set up owing to the

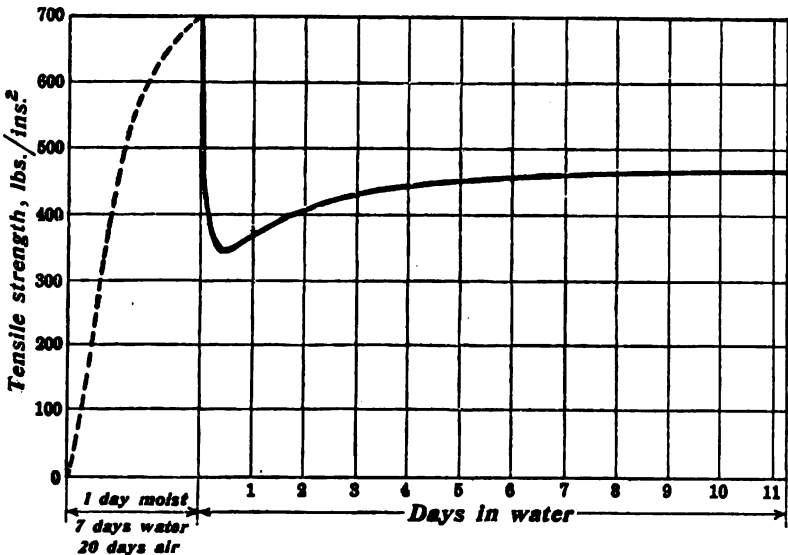

Fig. 8.—Curve showing effect of immersing a specimen of concrete previously dry.

fact of these changes occurring at the surface before the interior is affected. It follows that the effects will be more pronounced in small specimens, such as those tested, than in the large sections used in practice, which have less surface in relation to their volume. But even so they are important enough to

* This expansion and contraction was noted by Sir A. Binnie, *Proc. Inst. C.E.*, vol. clx. p. 21.

merit serious consideration. They would also be less marked in compression tests than in tensile tests, since the stress due to unequal expansion would be a smaller percentage of the whole. It must be remembered, however, that although the tensile strength is neglected in the calculation of principal stresses, it is always relied on to give the necessary adhesion, and is frequently allowed for in the calculation of the resistance to shear.

VARIATION OF STRESS AS AFFECTING DESIRABLE WORKING VALUES.

It is a well-known and thoroughly investigated fact that steel subjected to a large number of variations of stress is gradually weakened, and will ultimately fail if the maximum value of the stress exceeds a certain value, which depends not only on the material, but also on the magnitude of the variation of stress.

Thus, a rough approximation to the truth is obtained by stating that a specimen which has an ultimate stress of f will fail under a large number of applications of a stress of $\frac{2}{3} f$, when the stress falls to zero between each of the loadings, and will fail under many applications of a stress of $\frac{1}{3} f$, if this alternates between a tensile stress of that value and a compressive stress of equal intensity. The experimental researches of Wöhler on this point are so well known as to make a reference sufficient.*

Considering firstly the case of alternation between zero and a maximum value, it follows that steel of an ultimate strength of 60,000 lbs./ins.² would stand an application of 40,000 lbs./ins.² in this manner. A working stress of 16,000 lbs./ins.² would therefore be quite safe, and would provide an ample factor for ignorance and bad workmanship.

For complete reversal, however, a stress of only 20,000 lbs./ins.² would ultimately produce failure, and for this a working stress of 16,000 lbs./ins.² would certainly be unjustifiable. It remains to be considered whether in reinforced concrete complete reversal is ever obtained, and a consideration of usual

* See Unwin's *Elements of Machine Design*, Part I. pp. 33 ff.

practice will show that the stress in compression practically never exceeds one-half the usual working tensile strength.

With this reduced range of stress—intermediate between alternation and complete reversal—an application of a stress of 26,400 would ultimately cause failure. Taking then a real factor of safety of 2, it would appear unwise to stress the steel above 13,200 in such cases of reversal, and it would be desirable to keep it lower in cases where the increased cost is of less consequence than the increased safety of the structure.

As regards the stress in the concrete, this material is so different in its nature from steel, that to assume that the same proportion of the ultimate stress may be indefinitely repeated under the same range of stress without producing failure is certainly somewhat unjustifiable.

Unfortunately, the direct experimental evidence which should be resorted to in such a case is lacking. Profs. Berry and Van Ornum have published experiments on repetition of stress—the former tests showing that repetition of a stress of 940 lbs./ins.² did no harm to a good 1 : 1½ : 4½ granite concrete,* while the latter series appears to indicate that a repetition of 50 per cent. of the ultimate load may eventually cause fracture,† as against 66 per cent. in the case of steel.

No figures for reversal of stress are available at all, and in any case such reversal would necessarily be limited to the tensile strength of the concrete, which is, of course, far below even working compression stresses. In a beam subjected to complete reversal of moments—as a silo wall—the condition is practically a range from working compressive stress on the one hand to the opening of tension cracks on the other. The authors would anticipate that many reversals of this nature would be considerably more dangerous than is the case for steel. If we limit the fatigue of concrete to 50 per cent. for repetitive loading, and consider a concrete having an ultimate strength of 2000, a repeated stress of 1000 lbs./ins.² would ultimately produce failure, and taking a factor of safety of 2, our working stress should not exceed 500 lbs./ins.²

If we limit the fatigue of concrete under reversal to 30 per

* *Eng. Record*, July 25, 1908.

† *Trans. Am. Soc. Civ. Eng.*, 1907, vol. lviii.

cent. (*faute de mieux*), again taking a factor of 2, it would seem desirable that under conditions of reversal a working stress of 300 lbs./ins.² should not be exceeded.

The following table summarizes these recommendations:—

Material.	Range of stress.		
	Steady.	Varying between zero to maximum.	Alternating.
Steel in tension	lbs./ins. 16,000	lbs./ins. ² 16,000	lbs./ins. ² 18,200
Concrete in compression	600	500	300

PART I

CALCULATION OF STRESSES UNDER KNOWN FORCES AND MOMENTS

CHAPTER II

SIMPLE BENDING AND SIMPLE COMPRESSION

It is proposed to run over the elementary sections of this subject as rapidly as possible, since an engineer acquainted with the general principles of the design of structures will have no difficulty in following them. Those who find some amplification necessary may refer to the many elementary books already published.* Further, as this treatise is intended for the use of the designer rather than the historian, the history of the evolution of the accepted theory, and the alternative theories which have been suggested by eminent writers, will not be reviewed here. When we come to questions of secondary stresses—particularly as affecting the design of columns—the subject will be more fully dealt with, as these questions are not, to the authors' knowledge, adequately dealt with elsewhere.

The following assumptions are made in the calculations of primary stresses in a reinforced concrete member.

(1) The tension in the concrete is neglected, except in so far as it is required in adhesion and sometimes in shear.

(2) The modulus of elasticity of concrete is assumed as constant. It is generally taken to have a value $\frac{1}{15}$ th of that for steel. Accurately, however, it varies with the composition and age of the concrete, and for any particular concrete it is not quite a constant, decreasing for higher values of the applied

* The second report of the Royal Institution of British Architects may also be studied. This is given as Appendix II.

stress. At working stresses, however, the assumption that it is a constant is not greatly at fault. A value of $m = 15$ is recommended by the R.I.B.A. Report (1911), by the Prussian Regulations, and by the American Society of Civil Engineers. The French regulations give m a variable value of from 8 to 15, depending upon the cross ties and binding in columns, while for beams $m = 10$ is suggested.

(3) The theory of plane sections remaining plane after bending of a member is adhered to, except in a few special cases, such as sharply bent members, when it is not sufficiently accurate.

The notation on page xviii will be adhered to, except where otherwise stated.

SIMPLE BENDING.

(a) **Rectangular Beams reinforced on Tension Side only.**— Since the strain diagram is a straight line, the triangles in the strain diagram are similar.

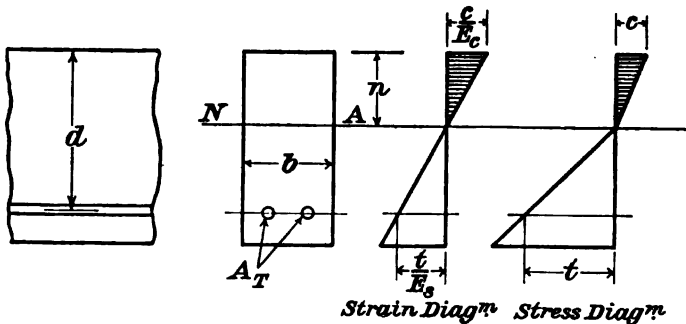

FIG. 9.—Rectangular beam under simple bending.

Therefore

$$\frac{\frac{c}{E_c}}{t} = \frac{n}{d - n} \dots \dots \dots (1)$$

Since the total compression will equal the total tension,

$$\frac{1}{2}c \cdot b \cdot n = A_T \cdot t \dots \dots \dots (2)$$

Substituting

$$p = \text{percentage of steel} = \frac{100A_T}{bd}$$

$$m = \text{modular ratio} = \frac{E_s}{E_c}$$

$$n_1 = \frac{n}{d'}$$

we obtain from the above equations

$$n_1 = \sqrt{\left(\frac{mp}{100}\right)^2 + \frac{2mp}{100} - \frac{mp}{100}} \dots (3)$$

This quantity n_1 , the ratio of the depth of the neutral axis to the depth of the beam, is very important. It will be seen that for simple bending it is fixed by the modular ratio and the percentage of steel alone.

Taking the modular ratio $m = 15$, n_1 simplifies to

$$(n_1)^{m=15} = \sqrt{0.0225p^2 + 0.3p} - 0.15p \dots (3a)$$

Table I. and the curves of Fig. 10 have been calculated from this formula.

TABLE I.
Depth of Neutral Axis.

p	Values of n_1		p	Values of n_1	
	m = 15	m = 10		m = 15	m = 10
0.4	0.292	0.250	0.75	0.375	0.319
0.5	0.319	0.270	1.0	0.418	0.359
0.6	0.345	0.291	1.5	0.482	0.418
(0.675)	0.360	0.306	2.0	0.530	0.463

In some cases it is more accurate to take a higher value for E_c , and consequently a lower value for m than 15. Hence n_1 has also been calculated for $m = 10$, and plotted on Fig. 10.

$$(n_1)^{m=10} = \sqrt{0.01p^2 + 0.2p} - 0.1p \dots (3b)$$

A comparison of the two will show what error is involved in using an incorrect value of E_c .*

It has been shown that the depth of the neutral axis is

* With poorer aggregates, such as brick, m may have a value considerably more than 15, as much as 25 having been taken in many cases.

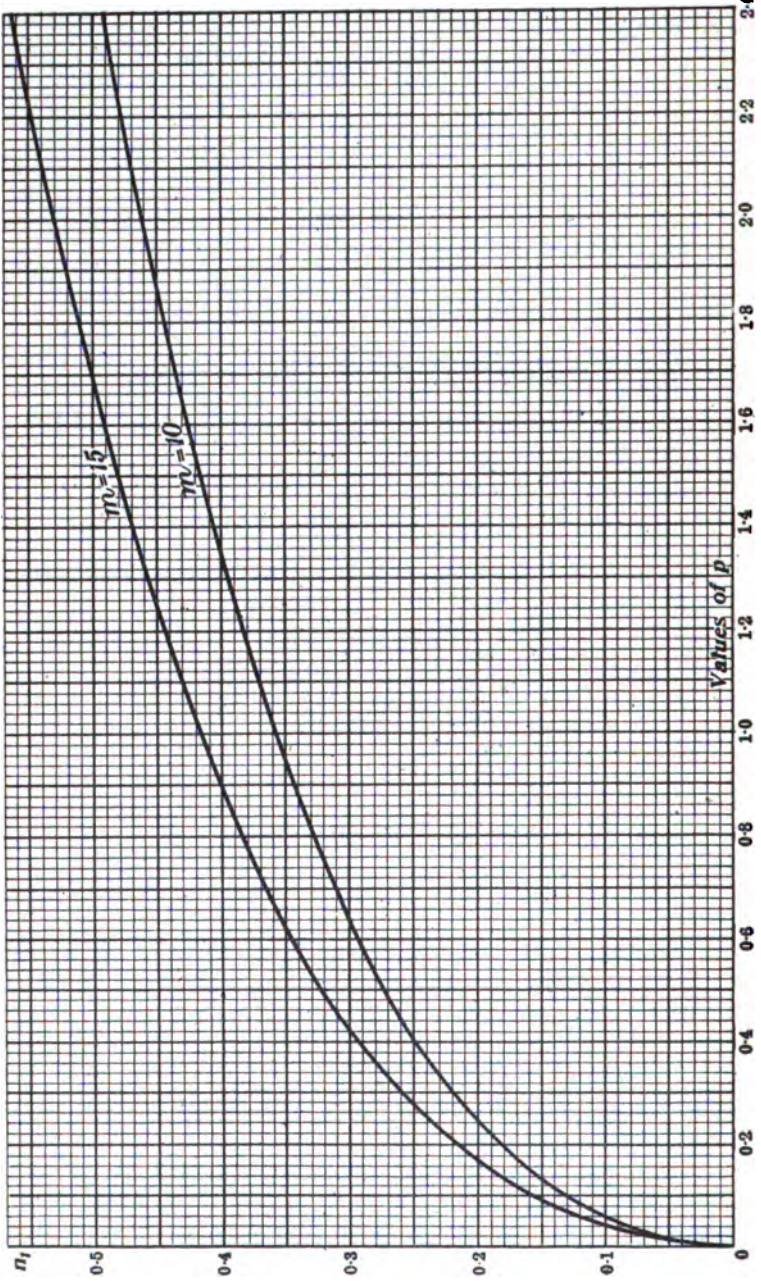

Fig. 10.—Depth of the neutral axis for various percentages of steel.

fixed when p is fixed. It follows that for any value of p or n_1 there can be only one value of $\frac{t}{c}$, the ratio of the extreme fibre stresses. This relationship is sometimes very convenient, and may be found at once from equation (1).

$$t_1 = \frac{t}{c} = \frac{(1 - n_1)m}{n_1} \dots \dots \dots (4a)$$

$$n_1 = \frac{n}{d} = \frac{m}{t_1 + m} \dots \dots \dots (4b)$$

Where the percentage is given, and consequently n_1 is also fixed, the following relationship may be convenient, and may easily be obtained from the fundamental equations:—

$$t_1 = \frac{n_1}{2p} \times 100 \dots \dots \dots (5)$$

When using this formula it should be remembered that t_1 and n_1 are not independent variables.

The expression for n_1 given by equation (3) may be substituted in either of the above, but it is easier to take its value from Table I. for any value of p .

Example.—Find the ratio $\frac{t}{c}$ for 1 per cent. of steel, taking $m = 15$.

From Table I., $n_1 = 0.418$.

Therefore from equation (5), or from the curve of Fig. 11,

$$t_1 = \frac{0.418 \times 100}{2} = 20.9$$

In Table II. and Fig. 12 the ratio $\frac{t}{c}$ has been calculated for different values of p , for $m = 15$ and $m = 10$.

TABLE II.

Ratio of Stresses, $t_1 = \frac{t}{c}$.

p	Values of t_1		p	Values of t_1	
	$m = 15$	$m = 10$		$m = 15$	$m = 10$
0.4	36.5	31.2	0.75	25.0	21.3
0.5	31.9	27.0	1.0	20.9	17.9
0.6	28.6	24.4	1.5	16.1	13.9
(0.675)	26.7	22.7	2.0	13.8	11.6

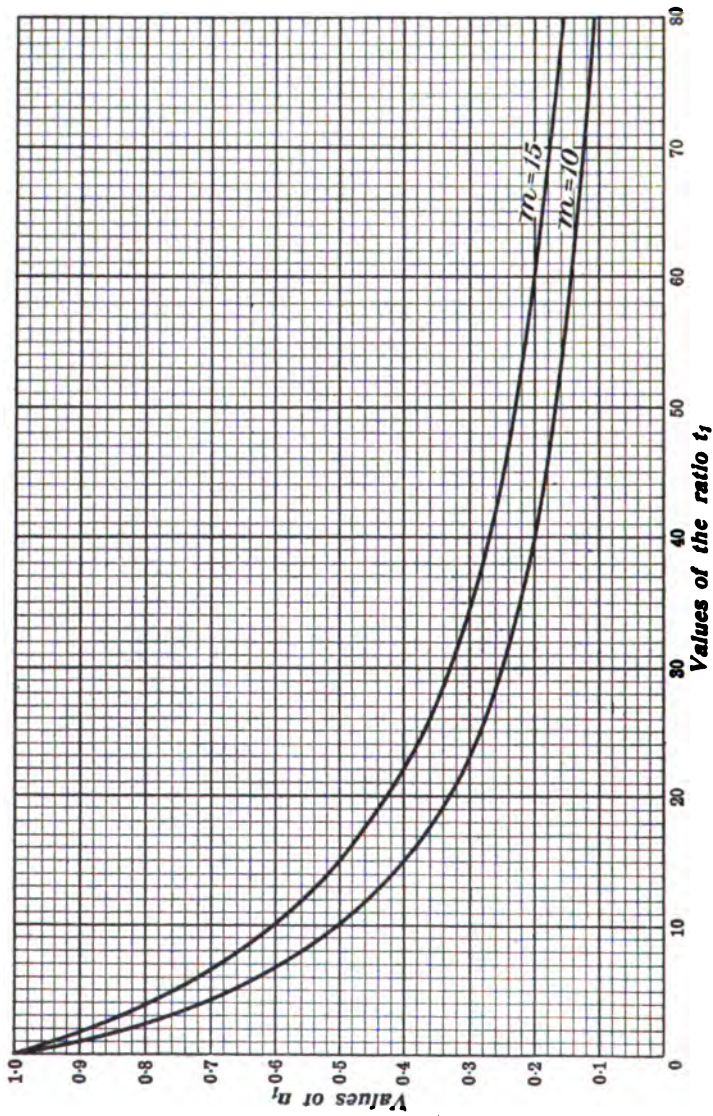

FIG. 11.—Depth of the neutral axis for various ratios of stresses $t_1 = \frac{t}{c}$.

From Table II. and Fig. 12 it will be seen that if the ratio of stresses is specified, the percentage of steel is fixed. Taking, for instance,

$$\begin{aligned} c &= 600 \text{ lbs./ins.}^2 \\ t &= 16,000 \text{ lbs./ins.}^2 \end{aligned}$$

we have
$$t_1 = \frac{16,000}{600} = 26.7$$

and therefore, from Table II. (taking $m = 15$),

$$p = 0.675.$$

In practice, however, it is generally more important to specify that certain stresses shall not be exceeded, which is not quite the same as specifying a certain ratio of stresses. If, for instance, 600 or 16,000 may not be exceeded, there is no objection to using 1 per cent. of steel, which gives $t_1 = 19.6$. But it must then be noticed that if we adopt a stress of 600 in the concrete, the steel stress may only be figured at $19.6 \times 600 = 11,760$. If the steel stress were taken at 16,000, the concrete will be over-stressed to

$$c = \frac{16,000}{19.6} = 817.$$

The best percentage of steel is then to be decided by questions of economy. Without going into the question here,* it may be stated that it depends on the relative price of steel and concrete, and upon the ratio of dead load to total load. Under usual conditions, it is generally economical to use that percentage which develops at the same time the permissible stresses in the concrete and in the steel. For stresses of 600 and 16,000 this percentage is 0.675.

When it is desirable to make the construction as light as possible, the percentage should be increased, which does not generally involve a great sacrifice of economy.

Where high carbon steel and a higher steel stress are used (without changing the concrete stress), a lower percentage may be more economical. Thus, with stresses of 675 and 20,000

* The reader is referred to an article on "Economy in Reinforced Concrete Design," by Oscar Faber, *Engineering*, August 7 and 14, 1908.

lbs./ins.² in the concrete and steel respectively the percentage is

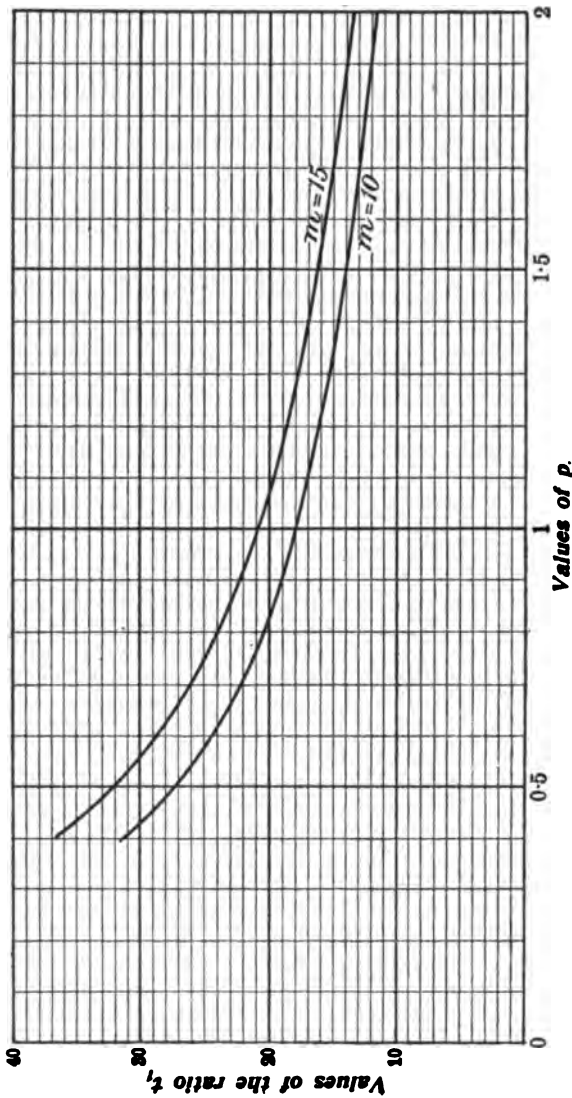

FIG. 12.—Ratio of stresses $t_1 = \frac{t}{c}$ for various percentages.

0.57. It will be found, however, that very little gain in economy is obtained by this method.

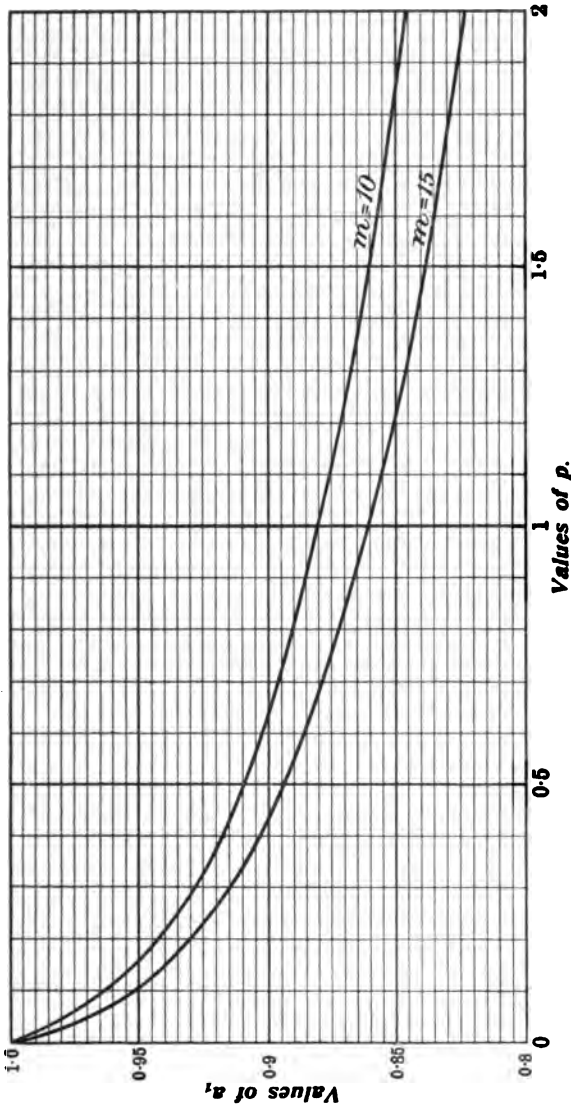

FIG. 13.—Radius arm of internal forces for various values of p .

It may be noted that the relationship between n_1 and t_1 depends only on the strain diagram being a straight line, and

Fig. 11 is therefore applicable always, *i.e.* even in cases where direct compression or tension is combined with bending.

In the relationship between p and n_1 and p and t_1 , the further condition is included that the total tension shall equal the total compression, and for that reason Figs. 10, 12, and 13 apply to cases of simple bending only.

The moment of resistance of a beam may now be calculated without any difficulty. The centre of compression will be $\frac{n}{3}$ from the top, and the centre of tension, d from the top. Hence radius arm of internal forces

$$a = d - \frac{n}{3}$$

The ratio $a_1 = \frac{a}{d}$ is given in Table III. and Fig. 13 for various values of p , and in Fig. 14 for various values of t_1 .

TABLE III.

p	Values of a_1		p	Values of a_1	
	$m = 15$	$m = 10$		$m = 15$	$m = 10$
0.4	0.908	0.917	0.75	0.875	0.898
0.5	0.894	0.910	1.0	0.861	0.881
0.6	0.885	0.908	1.5	0.839	0.861
(0.675)	0.880	0.898	2.0	0.823	0.846

The percentage of steel seldom falls outside the limits $p = 0.5$ and $p = 1.0$. It will be seen that within these limits the variation of a_1 is only from 0.861 to 0.894 with $m = 15$, and from 0.881 to 0.910 with $m = 10$. It follows that if we put $a_1 = 0.88$ no appreciable error will be introduced, and calculations will be considerably simplified.

The resisting moment of the beam is obtained by multiplying the total compression, or the total tension by the radius arm a . Hence the resisting moment

$$R = \frac{1}{2}cbn\left(d - \frac{n}{3}\right) \dots \dots \dots (6a)$$

$$= A_s t \left(d - \frac{n}{3}\right) \dots \dots \dots (6b)$$

Here c and t are the actual stresses in the slab, and the two expressions for R are necessarily equal for simple bending.

If, however, we denote by c and t the *permissible* working

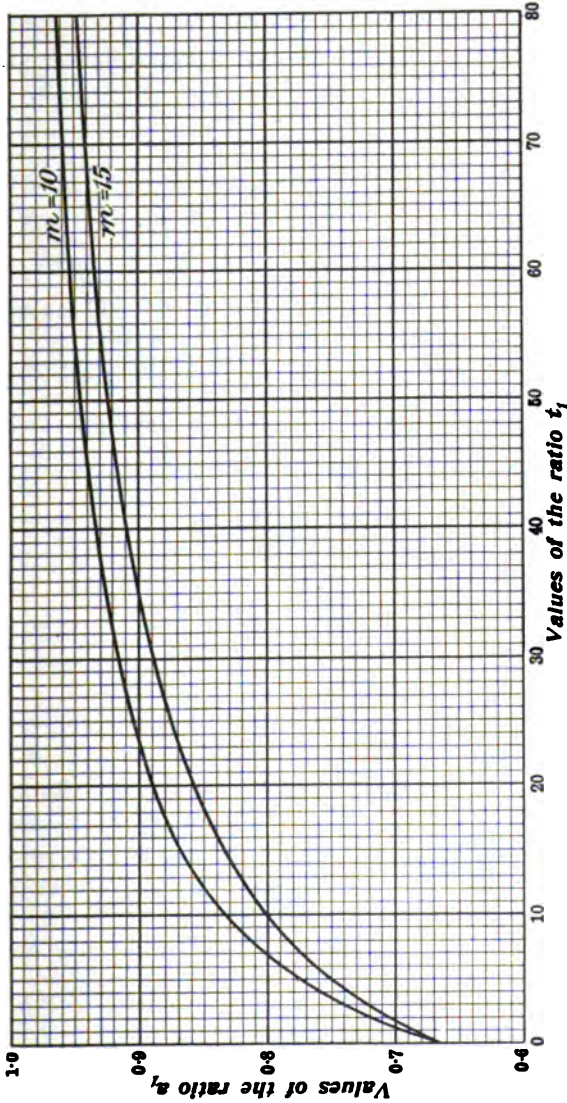

FIG. 14.—Radius arm of internal forces for various values of $t_1 = \frac{t}{c}$.

stresses, the expressions may not be equal, and the correct value of R is then determined by the lower of the two.

Example.—Calculate the resisting moment of the beam in Fig. 15, with permissible stresses of 600 and 16,000, and $m = 15$.

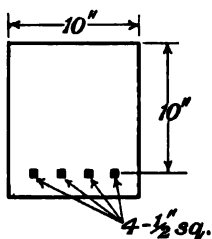

FIG. 15.

Here $p = 1$ per cent.

$\therefore a = 8.61$ ins. from Table III.

$n = 4.17$ ins. " " I.

Hence from (6a)

$$R = 300 \times 10'' \times 4.17'' \times 8.61'' \\ = 108,000 \text{ lb.-ins.}$$

From (6b)

$$R = 1 \times 16,000 \times 8.61'' = 138,000 \text{ lb.-ins.}$$

Hence the safe moment of resistance is 108,000 " "

Since for any value of p , R varies as bd^2 , it is convenient to calculate $\frac{R}{bd^2}$. This has been done for permissible stresses of 600 and 16,000, and the results are given in Table IV. and Fig. 16.

TABLE IV.

p	Value of $\frac{R}{bd^2}$		p	Value of $\frac{R}{bd^2}$	
	$m = 15$	$m = 10$		$m = 15$	$m = 10$
0.4	57.8	58.6	0.75	98.4	85.5
0.5	71.5	72.8	1.0	107.5	94.7
0.6	85.0	78.8	1.5	121.4	108.0
(0.675)	95.0	82.4	2.0	131.0	117.8

The break in the curve is the critical point showing the percentage at which the permissible stresses in steel and concrete are *both* reached. Beams with a higher percentage have a steel stress less than 16,000, and beams with a lower percentage a concrete stress less than 600.

From Table IV., R may be calculated for any beam by multiplying the tabulated value of $\frac{R}{bd^2}$ by bd^2 . Thus, in the last example,

$$p = 1 \text{ per cent}$$

$$\frac{R}{bd^2} = 108$$

$$\therefore R = 108 \times 10 \times 100 = 108,000 \text{ lb.-ins.}$$

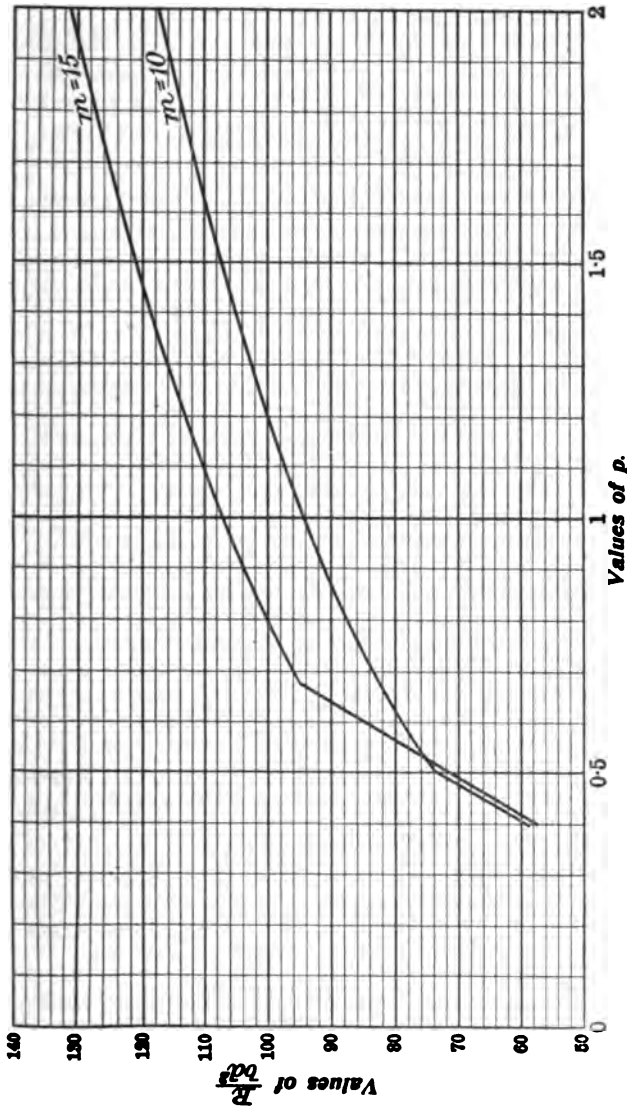

FIG. 16.—Moments of resistance of beams for various values of p . Maximum stresses, $c = 600$, and $t = 16,000$ lbs./ins.²

(b) **T-beams.**—It will be seen from the foregoing analysis of rectangular beams, that since the tension of the concrete is neglected, the concrete below the neutral axis does not add to the moment of resistance, but increases the dead load on the beam. For this reason, a light and cheap construction is obtained by omitting this concrete under the greater portion of the slab, and concentrating the steel in the ribs so left. The necessary width of these ribs is determined by considerations of shearing stresses, and partly by the negative moments at the supports of continuous beams.

An individual rib in such a construction is referred to as a **T-beam**, and as such beams are used almost universally in floor construction, they must be considered.

Referring to Fig. 17 of a cross-section through such a construction, a little consideration will show that the compressive

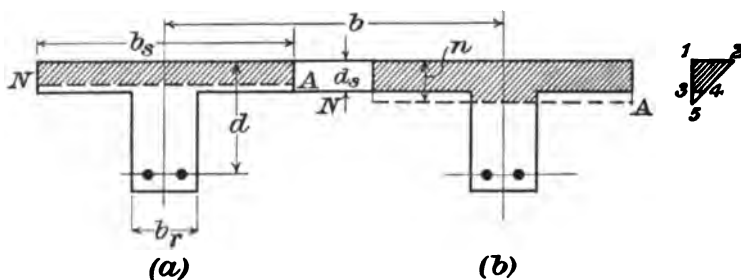

FIG. 17.—Cross-section through T-beam.

stress in the slab due to the beam will be greater immediately above the rib than halfway between the ribs. This may be seen qualitatively from several considerations.

Unfortunately, there does not appear to be any experimental evidence to determine to what extent this is true. An allowance may be made by taking b_s , the effective width of slab forming the compression member of beam, less than b .

The R.I.B.A. Report (1911) (see p. 300) suggests that—

- | | | | |
|-------|----------------------------|------------------------|--------------------------------|
| b_s | should not be greater than | $\frac{3}{4}$ of b , | the distance between the ribs, |
| " | " | " | $\frac{1}{3}$ of l , |
| " | " | " | 15 times d_s , |
| | | | the thickness of the slab, |
| " | " | " | 6 times b_r , |
| | | | the breadth of the rib. |

The American report is more conservative, and limits b_s to $\frac{1}{4}l$ or approximately $10d_s$.

Neither of these regulations is at all satisfactory, as they neglect, on the one hand, the reinforcement in the slab, and on the other hand do not differentiate between freely supported and continuous beams, which is important as regards the rule that b_s shall not exceed $\frac{1}{3}l$.

In the opinion of the authors, no such arbitrary rule is very helpful, and the question should be determined by considerations of shearing stresses in the slab (see p. 90).

In any particular beam, when b_s , d , and A_r are fixed, the percentage of steel may be calculated by

$$p = \frac{100 \cdot A_r}{b_s \cdot d},$$

and the depth of the neutral axis, the radius arm, and the moment of resistance determined as for a rectangular beam of a width b_s , by Tables I. to IV., or the corresponding curves.

Example.—In a certain T-beam, $b_s = 90$ ins., $d = 15$ ins., $A = 4$ ins.², $d_s = 4$ ins. Calculate the safe moment of resistance. Stresses 16,000 and 600.

$$\text{Here } p = \frac{4 \times 100}{90 \times 15} = 0.296.$$

$$\begin{aligned} \text{Hence, from Fig. 16, } R &= 42.5 \times 90 \times (15)^2 \\ &= 860,000 \text{ lb.-ins.} \end{aligned}$$

For these curves to apply exactly, the neutral axis must not fall below the underside of the slab, as in Fig. 17 (a). In the example above, $n = 0.264 \times 15 = 3.95$ ins., and the curves therefore apply rigidly.

If it is found that it does fall below, as in Fig. 17 (b), an error is introduced by the absence of the triangle 3, 4, 5 in the stress diagram. When d_s is $\frac{4n}{5}$ the error involved in the calculation of the compression stress is only 4 per cent.

Exact formulæ are given for this case in the R.I.B.A. reports of 1907 and 1911 (see Appendix II., p. 300). In the opinion of the authors, these formulæ are too complicated for practical

use, and so long as the correct value of b is quite arbitrarily arrived at, there is no object in extreme accuracy in the subsequent steps. Hence the following approximate method is offered for practical requirements.

Use Tables I. to IV. in all cases when d_s is less than $\frac{1}{3}n$.
When $d_s > \frac{1}{3}n$, take—

$$\frac{n}{d} = \frac{m A_T}{m A_T + b_s \times d_s}$$

$$R = \text{radius arm} = d - \frac{d_s}{2}$$

$$\text{Then } C = \text{total compression} = \frac{M}{d - \frac{d_s}{2}}$$

$$\therefore c_m = \text{mean compression stress} = \frac{C}{b_s \times d_s}$$

$$c = \text{maximum compressive stress} = c_m \times \frac{n}{n - \frac{d}{2}}$$

In T-beams used in ordinary floor construction, it is generally found that the compressive stress is quite low, and its value therefore not required. In such cases, the area of steel is all that is required, and approximately

$$A_T = \frac{M}{\left(d - \frac{d_s}{2}\right)}$$

(c) **Rectangular Beams having compression reinforcement.**

A beam having reinforcement near its compressed edge is capable of resisting a greater compression force without exceeding the safe stress for concrete, and therefore enables a high percentage of steel on the tension side to be used at its full working stress. Hence such beams are of particular value in cases where it is desirable to reduce to a minimum the dead load due to the beam itself.

It also frequently happens that under different conditions of loading the two sides may be in tension alternately, in which cases it is necessary to have steel on both sides, and such steel will then assist to a certain extent in taking up the compression.

It is shown later (p. 44) that the stress in the longitudinal

bars of a compression member is m times the stress in the concrete immediately surrounding them.

This must be grasped before the present problem can be dealt with, and hence the reader is advised to study p. 44 if he is not familiar with the principle. It follows at once, from a consideration of the strains produced in the steel and the concrete, that since there is to be no movement between the steel and the concrete at any point, the strains must be the same for both.*

In addition to b and d , the dimensions of the member, there are three variables, A_r , A_c , and d_c , the latter quantity being the

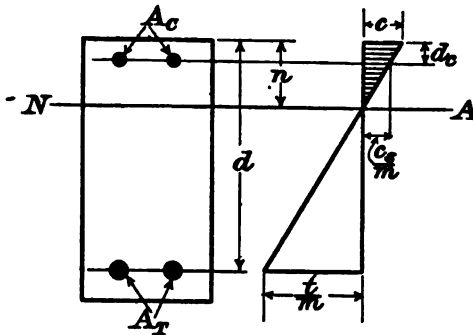

FIG. 18.—Beam with reinforcement in both compression and tension areas.

depth of the compression steel from the compressed edge. Exact formulæ may be derived involving these quantities, but they are very complex, since even the depth of the neutral axis is an expression worthy of some respect. Nor do these formulæ lend themselves well to representation on curves, as the number of variables is too great.

The difficulty may be overcome in two ways, either by reducing the number of variables, or by the use of an approximate calculation. Thus the number of variables may be reduced by putting $d_c = d/10$ † for example, by making A_c some fixed proportion of A_r , and then deriving a set of curves, or by

* Strains are not to be confused with stresses; the strain is the increase or reduction per unit length produced by stress, which is the load on a section divided by its area.

† See Turneure and Maurer's *Principles of Reinforced Concrete Construction*, and Taylor and Thompson's *Concrete Plain and Reinforced*.

assuming the compressive steel to be at the centre of gravity of the compressive forces; this last gives very simple results, and is equivalent to taking $d_c = d/10$ approximately.

It is to be noted that since practical examples will generally not fit such assumptions exactly—for example, d_c in a practical case will not generally be exactly $d/10$ —this method is really approximate too, and therefore has no advantage over the approximate calculations given below, which are applicable to all cases, and are susceptible of great accuracy where this is required, by carrying them to a second approximation.

The method consists in assuming a value for the depth of the neutral axis. The value of the compression reinforcement in reducing the compressive stress can then be calculated, and may be expressed by replacing the beam by a proportionately broader one, which would reduce the compression stress to the same extent. When the *equivalent beam* has been determined, it may be analyzed by the curves already given, in Figs. 10 to 16.

Example.—Let $M = 1,000,000$ lb.-ins.

$$\text{Here, from Fig. 19,} \quad p = \frac{5 \times 100}{20 \times 20} = 1.25,$$

and for this value (from Fig. 10), $n = 0.45d$
 $= 9$ ins.

As the effect of the compression reinforcement is to bring the neutral axis nearer to the compression face, we may take $n = 8$ ins. as our trial value.

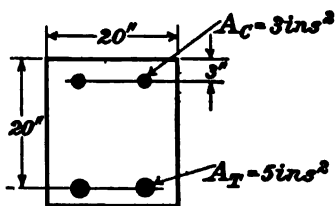

FIG. 19.

Then if c is the fibre stress on the concrete at 8 ins. from the neutral axis, the stress in the concrete at the steel at 5 ins. from the neutral axis will be $\frac{5}{8}c$, and as the stress in the steel at any point is m times the concrete stress at that point, the

stress in the compression steel will be $c_s = (c \times \frac{5}{8})m$.

Now, the total compression due to the concrete

$$\begin{aligned} &= b \times n \times \frac{c}{2} = 20 \times 8 \times \frac{c}{2} \\ &= 80c, \end{aligned}$$

The additional compression due to the steel bars

$$\begin{aligned} &= A_c(c \times \frac{5}{8} \times \overline{m - 1}) \\ &= 3(c \times \frac{5}{8} \times 14) \\ &= 26.2c. \end{aligned}$$

It will be seen that the same stress would be produced if the compression steel were omitted, and the width of beam increased to $20 \times \frac{80 + 26.2}{80} = 26.5$ ins.

The analysis may then proceed as usual, for this equivalent beam, $26\frac{1}{2}$ ins. wide with 5 ins.² of steel on the tension side.

$$p_1 = \frac{5 \times 100}{20 \times 26.5} = 0.942,$$

for which value we have $a = 0.864 \times 20 = 17.28$ ins. (from Fig. 13), and $t_1 = 21.5$ (from Fig. 12).

$$\text{Hence } t = \frac{M}{A_r \times a} = \frac{1,000,000}{5 \times 17.28} = 11,550 \text{ lbs./ins.}^2$$

$$\text{and } c = \frac{t}{t_1} = \frac{11,550}{21.5} = 538 \text{ lbs./ins.}^2$$

The value of n corresponding to $p = 0.942$ is $0.41 \times 20 = 8.2$ ins., which agrees sufficiently well with the value 8.0 assumed.*

It is evident that the example has been worked out in great fulness to make the method clear, and that the results could be obtained in a few lines once the method has been grasped.

In connection with the compression reinforcement of beams, the following points are important.

The stress in the compression steel can never exceed mc , and will generally be much less, say $0.6mc$, owing to the steel being between the neutral axis and the compressed edge. Putting $m = 15$ and $c = 600$, this means that the steel stress will never exceed 9000 lbs./ins.², and will generally be as low as 5400 lbs./ins.²

* The error in the determination of the stress is much less than is represented by the disagreement between 8.2 and 8.0.

Consider now a beam with 0.675 per cent. of steel, stressed to 600 and 16,000. If it is required to strengthen the beam by increasing the percentage of steel in tension, and adding enough compression steel to keep the concrete stress down to 600, it will be found that since the total compression must still equal the total tension, and since the tension steel is stressed to 16,000 and the compression steel to only 5400, for example, it is necessary to add $\frac{16,000}{5,400} = 3 \text{ ins.}^2$ (approximately) to the compression steel for every additional square inch of tensile steel.

Hence a point is soon reached when as much steel is required on the compression as on the tension side. If the same process were continued beyond this point, we should have more compression than tension steel. Such an arrangement is very unusual in practice.

It is important, where longitudinal steel is used in compression, that it be prevented from buckling. The concrete between it and the tensile steel will prevent buckling inwards, so that all that is necessary is the provision of ties at intervals to prevent outward buckling (see Columns, p. 97).

To prevent sideway buckling of the compression *flange* as a whole, its width must not be too small in comparison to the span.

SIMPLE COMPRESSION.

Compression Members concentrically loaded and symmetrically reinforced.

A column consisting partly of concrete and partly of longitudinal steel has properties which are very complex, owing to the tendency of the longitudinal steel to buckle unless held in at close intervals by some form of binding, and the fact that such binding, when adopted, tends to prevent the lateral dilation of the concrete quite apart from its action on the longitudinal bars. These problems are discussed in Chapter V.

Without entering here into these questions, it will be convenient to discuss the strength of such a column under certain

assumptions, and leave till later the question as to the conditions under which these assumptions hold. It will therefore be assumed that the condition of the steel is such that no tendency to buckle exists, and that the steel is capable of resisting any stress (up to its elastic limit) which may be imposed upon it.

It may make the nature of the problem more clear to state that it is incorrect to take as the safe load on the column the sum of the safe loads on the steel and the concrete, working each at its safe stress. The reason for this is that at those stresses the shortening of the column under the load would be different for the two materials, whereas the conditions of practice, requiring that the steel and concrete should not move relatively to one another, require also that this shortening shall be identical for the two materials.

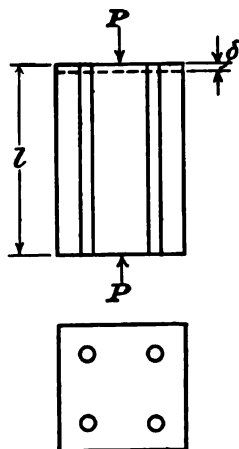

FIG. 20.—Symmetrically reinforced member under concentric compression load.

- Let A = total area,
- A_L = area of steel,
- P = total load.

If there is no slipping between the steel and the concrete, the deformation δ will be the same for both. Hence the stresses in steel and concrete will vary as the coefficient of elasticity. From Hooke's law,

$$P_s = \text{load carried by steel} = A_L \frac{\delta}{l} \cdot E_s$$

$$P_c = \text{load carried by concrete} = (A - A_L) \cdot \frac{\delta}{l} \cdot E_c$$

The sum of these must equal the applied load ;

$$\therefore P = A_L \cdot \frac{\delta}{l} \cdot E_s + (A - A_L) \cdot \frac{\delta}{l} \cdot E_c$$

Putting $E_s = mE_c$;

$$P = E_c \cdot \frac{\delta}{l} (A_L \cdot m + A - A_L).$$

The expression $E_c \cdot \frac{\delta}{7}$ is the stress in the concrete = c ;

$$\therefore P = c(A + A_s(m - 1)) \dots \dots (7)$$

It will be seen from this that the steel is as effective as $(m - 1)$ times its area of concrete. For this reason, the expression

$$A + (m - 1)A_s$$

is frequently referred to as the "equivalent concrete area," and denoted by A_e .

Formula (7) must not be used for column design unless certain considerations as to lateral binding, buckling, etc., are taken into account (p. 97). Generally, too, columns have secondary moments to resist (see Chap. VII.).

CHAPTER III

BENDING COMBINED WITH DIRECT FORCES

I.—BENDING AND TENSION

WHERE the moment and the direct tension are known, these may be replaced by the direct tension acting at a certain distance e from the original line of tension (which is generally the centre of the section).

Then if T = total tension, and M = moment,

$$e = \frac{M}{T}$$

Case I. Where both sides of the member are in tension.—This occurs when the resultant T lies inside the limits of d , and only members reinforced on both sides are suitable for such loading.

In the following formulæ, the tension is assumed to be taken up entirely by the steel alone.

Let stress in $A_1 = t_1$,

„ „ „ $A_2 = t_2$,

then

$$t_1 A_1 = \frac{T(\frac{d}{2} + e)}{d} \dots \dots \dots (1)$$

$$t_2 A_2 = \frac{T(\frac{d}{2} - e)}{d} \dots \dots \dots (2)$$

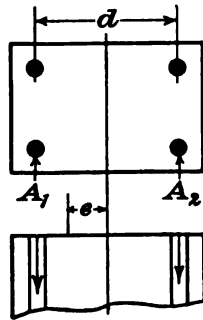

FIG. 21. — Bending combined with tension, T falling within d .

It is important that where the tension may exist without the moment, neither steel member should be designed for less than half the direct tension. Where T only falls slightly

outside the limit of d , the formulæ still hold with sufficient accuracy, t_2 becoming negative.

Case II. Where T falls appreciably outside the limits of d —members singly reinforced.

(For solution with members having compression reinforcement, see p. 56.)

Let T = direct tension,
 M = external moment.

Assume stresses t and c to be known. Then

$$\frac{n}{d} = \frac{mc}{t + mc}$$

$$\text{Total compression} = \frac{nb}{2} \times c$$

$$\text{Total tension} = A \cdot t$$

$$\therefore T = A \cdot t - \frac{nb}{2} c \quad \dots \dots (3)$$

Taking moments about the centre of tension,

$$T(e - f) = \frac{nb}{2} \cdot c \times \left(d - \frac{n}{3}\right) \quad \dots \dots (4)$$

Put $M = Te$, where e = eccentricity.*

Dividing (4) by (3)—

$$\begin{aligned} (e - f) &= \frac{\frac{nb}{2} c - \frac{n^2 bc}{6}}{\frac{pbd}{100} \cdot t - \frac{nbc}{2}} \\ &= \frac{\left(d - \frac{n}{3}\right) 50 \frac{c}{t} \cdot n}{pd - 50 \frac{c}{t} n} \quad \dots \dots (4a) \end{aligned}$$

$$\frac{n}{d} = \frac{mc}{t + mc} = \frac{mc}{ct_1 + mc} = \frac{m}{t_1 + m}$$

where $t_1 = \frac{t}{c}$ as before

$$\therefore d - \frac{n}{3} = d \left(1 - \frac{n}{3d}\right)$$

* The eccentricity is to be measured about a line xx in which the direct

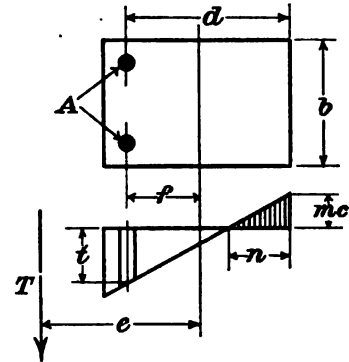

FIG. 22.—Bending combined with tension, T falling outside d .

$$= d \left\{ 1 - \frac{m}{3(t_1 + m)} \right\}$$

$$= \frac{d(t_1 + \frac{2}{3}m)}{t_1 + m}$$

Substituting this value of $d - \frac{n}{3}$ in (4a), we have—

$$\frac{e - f}{d} = \frac{\frac{t_1 + \frac{2}{3}m}{t_1 + m} \cdot \frac{50}{t_1} \cdot \frac{md}{t_1 + m}}{pd - \frac{50}{t_1} \cdot \frac{md}{t_1 + m}}$$

Dividing top and bottom by $\frac{d}{t_1 + m}$

$$\frac{e - f}{d} = \frac{\frac{t_1 + \frac{2}{3}m}{t_1 + m} \cdot \frac{50m}{t_1}}{p(t_1 + m) - \frac{50m}{t_1}} \dots \dots (5)$$

When $m = 15$, this becomes—

$$\frac{e - f}{d} = \frac{\frac{(t_1 + 10)}{t_1 + 15} \cdot \frac{750}{t_1}}{p(t_1 + 15) - \frac{750}{t_1}} \dots \dots (5a)$$

and where $m = 10$,

$$\frac{e - f}{d} = \frac{\frac{(t_1 + \frac{20}{3})}{t_1 + 10} \cdot \frac{500}{t_1}}{p(t_1 + 10) - \frac{500}{t_1}} \dots \dots (5b)$$

The curves of Figs. 23 and 24 give values of t_1 for $\frac{e - f}{d}$ up to 4, and for percentages of steel up to 3, m being taken as 15 in Fig. 23 and as 10 for Fig. 24. Where higher percentages are used, the example will, as a rule, fall under Case I.

With higher values of $\frac{e - f}{d}$ the solution may be obtained by Case III.

The problem of finding stresses in a given member by the use of curves 23 or 24 will be found simple. The quantities tension is applied. In the case of silo walls, etc., this may be taken at the centre of the section.

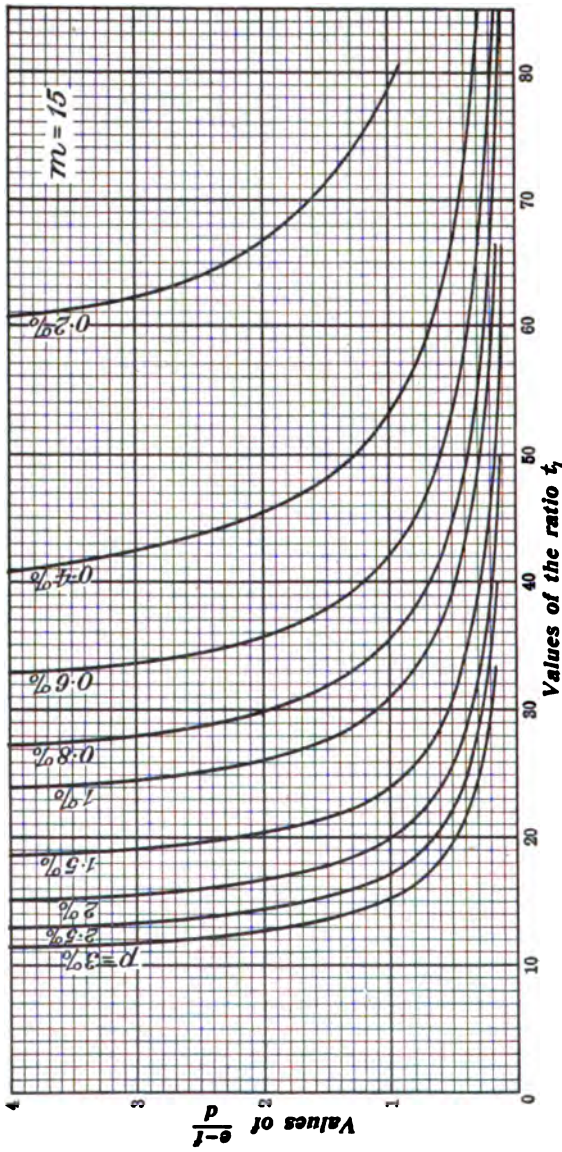

FIG. 23.—Values of $\frac{e}{d}$ for $m = 15$.

For use in calculating members subjected to combined bending and tension.

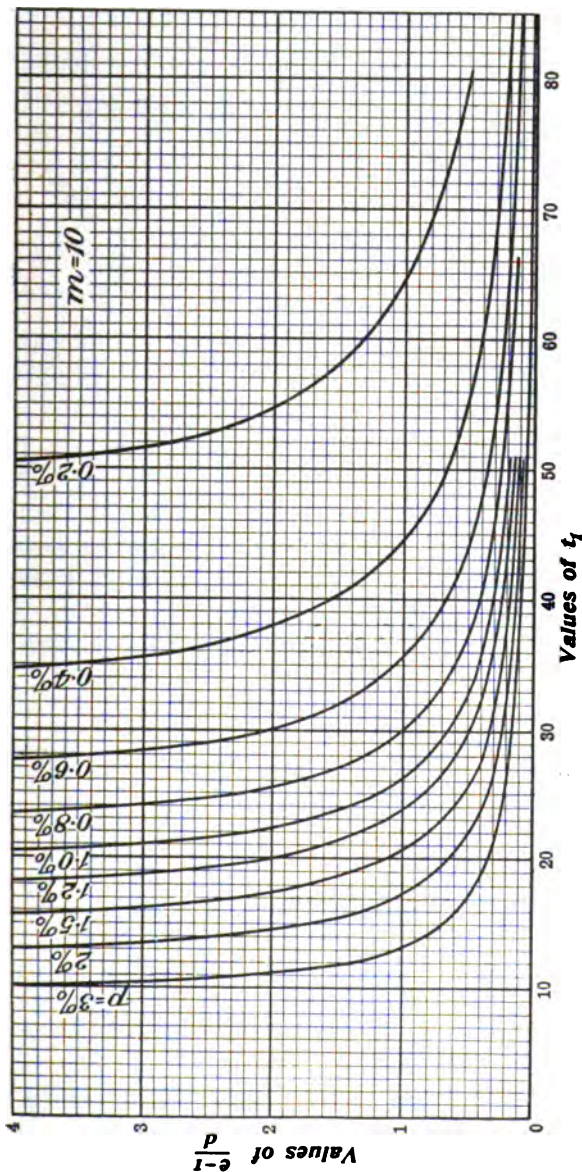

FIG. 24.—Values of $\frac{e}{d}$ for $m = 10$.

For use in calculating members subjected to combined bending and tension.

b , d , A (and therefore p) relating to the member, and the applied force T , acting at a distance e , are known. Hence $\frac{e-f}{d}$ is known, and the value of t_1 may be at once determined

from curve 23 or 24, using the appropriate value of p .

Then from formula 3,

$$\begin{aligned} T &= A \cdot t - \frac{nb}{2} \cdot c \\ &= At - \frac{bd}{2} \cdot \frac{m}{t_1 + m} \cdot t \end{aligned}$$

since $n = d \frac{m}{t_1 + m}$

and $c = \frac{t}{t_1}$.

Whence

$$t = \frac{T}{A - \frac{bd}{2} \cdot \frac{m}{(t_1 + m)t_1}} \dots \dots (6)$$

Frequently, however, the denominator of this expression is a small difference between two relatively large quantities, and therefore the following solution is much more accurate.

Multiply equation (3) by $(d - n/3)$ and add to equation (4).

Then $T \left\{ e - f + \left(d - \frac{n}{3} \right) \right\} = At \left(d - \frac{n}{3} \right)$

$$\therefore T = At \frac{\left(d - \frac{n}{3} \right)}{(e - f) + \left(d - \frac{n}{3} \right)}$$

or

$$t = \frac{T}{A} \cdot \frac{(e - f) + \left(d - \frac{n}{3} \right)}{\left(d - \frac{n}{3} \right)} \dots \dots (7)$$

As before $(e - f)$ is given, and the quantity $(d - n/3)$ is dependent only on t_1 , the ratio of stresses.

Hence by taking the correct value of t_1 from the curves of Fig. 23 or Fig. 24, and finding the corresponding values of $(d - n/3)$ from the curve of Fig. 14 (see p. 35), t may be readily obtained from (7), and this solution is susceptible of

great accuracy since $(d - n/3)$ varies only slowly with varying values of t_1 .

Case III. Solution for values of $\frac{e-f}{d}$ greater than 4.—In this case, the tensile force is so small compared to the bending moment that the member may be designed for the bending moment as a simple beam, and the effect of the tension may be taken with sufficient accuracy as increasing the tensile stress by $\frac{T}{2A}$ on the steel, and reducing the compressive stress on the concrete by $\frac{T}{bd}$.

An example will make this clear.

Suppose the steel to consist of two $\frac{5}{8}$ " diam. rods, when

$$A = 0.614 \text{ in.}^2$$

$$\text{and } p = \frac{0.614}{60} \times 100 = 1.02.$$

Let $T = 800$ lbs., and M measured about the axis = 36,000 lb.-ins.

$$\text{Then } e = \frac{36000}{800} = 45''$$

$$\text{and } e - f = 40''$$

$$\therefore \frac{e-f}{d} = 4.$$

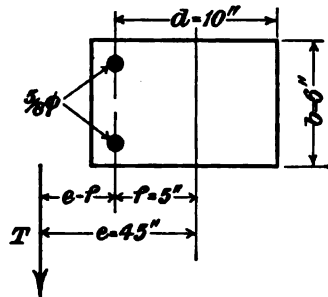

FIG. 25.

This case then lies on the boundary between Cases II. and III.

Solution by Case II.—From formula (7),

$$t = \frac{T}{A} \times \frac{(e-f) + (d - \frac{n}{3})}{(d - \frac{n}{3})}$$

Taking $m = 15$, we have from the curve of Fig. 23—

$$t_1 = 23.3$$

and hence from the curve of Fig. 14 (p. 35)—

$$\begin{aligned} (d - \frac{n}{3}) &= 0.87d \\ &= 8.7 \text{ ins.} \end{aligned}$$

$$\begin{aligned} \text{Hence } t &= \frac{800}{0.614} \cdot \frac{(40 + 8.7)}{8.7} \\ &= 7280 \text{ lbs./ins.}^2 \\ c &= \frac{t}{t_1} = 313 \text{ lbs./ins.}^2 \end{aligned}$$

Solution by Case III. (Approximate only.)—From $p = 1.02$ we have, neglecting direct tension, by the curve of Fig. 10 (p. 28)—

$$n_1 = \frac{n}{d} = 0.42$$

$$\begin{aligned} \text{Hence total compression} &= 0.42 \times 10 \times 6 \times \frac{c}{2} \\ &= 12.6c \end{aligned}$$

$$\text{Radius arm} = 0.86 \times 10 = 8.6''$$

$$\therefore c = \frac{36,000}{8.6 \times 12.6} = 333 \text{ lbs./ins.}^2$$

$$t = \frac{36,000}{8.6 \times 0.614} = 6830 \text{ lbs./ins.}^2$$

To allow for direct tension, increase t by

$$\frac{T}{2A} = \frac{800}{2 \times 0.614} = 650 \text{ lbs./ins.}^2$$

whence

$$t = 7480 \text{ lbs./ins.}^2$$

$$\text{Decrease } c \text{ by } \frac{T}{bd} = \frac{800}{60} = 13 \text{ lbs./ins.}^2$$

whence

$$c = 320 \text{ lbs./ins.}^2$$

It will be seen that these results agree well enough with those obtained under Case II., and the accuracy of Solution III. increases with increasing values of $\frac{e-f}{d}$.

The curves of Figs. 23 and 24 will also be found convenient for designing, as opposed to the calculation of stresses in a given member. Suppose, for instance, it be desired to design a member having a bending moment of 100,000 in.-lbs., and a direct tension of 5000 lbs.

$$\text{Here } e = \frac{100,000}{5000} = 20''.$$

Assume the overall depth of member = 12" which with 2" to the centre of the steel gives $d = 10''$.

With the tension acting at the centre of the section, $f = 4''$;

$$\therefore \frac{e-f}{d} = \frac{20-4}{10} = 1.6.$$

If we are using $m = 15$, a horizontal line on the curve of Fig. 23 corresponding to $\frac{e-f}{d} = 1.6$ will show at once what value of p is necessary for any selected value of t_1 .

Thus, if we take $c = 600$, $t = 16,000$,

$$t_1 = \frac{t}{c} = 26.7$$

and with this value of t_1 , $p = 1.1$.

The value of $\frac{(d - \frac{n}{3})}{d}$ corresponding to $t_1 = 26.7$ is 0.88 (Fig. 14).

$$\therefore d - n/3 = 0.88 \times 10 = 8.8 \text{ ins.}$$

whence, from (7)—

$$\begin{aligned} A &= \frac{T}{t} \frac{(e-f) + (d - \frac{n}{3})}{(d - \frac{n}{3})} \\ &= \frac{5000}{16,000} \times \frac{(16 + 8.8)}{8.8} = 0.88 \text{ in.}^2 \end{aligned}$$

Hence with $p = 1.1$,

$$\begin{aligned} bd &= \frac{0.88 \times 100}{1.1} \\ &= 80 \text{ ins.}^2 \end{aligned}$$

whence

$$b = \frac{80''}{10} = 8''.$$

Economy.—In pieces subjected to combined bending and tension in which both b and d are variables, economy is generally obtained by making $\frac{d}{b}$ as great as possible, especially

where $\frac{e-f}{d}$ is small.

Thus, if stresses of 16,000 and 600 are adhered to, and the last example be re-designed with an overall depth of 18" or $d = 16$, it will be found that the area of steel is reduced to 0.56 sq. in., and the breadth to 2.2".

Thus the steel is reduced by $\left(\frac{0.81 - 0.56}{0.81}\right) \times 100 = 31$ per cent., and the concrete by

$$\frac{12 \times 7.35 - 18 \times 2.2}{12 \times 7.35} \times 100 = 55 \text{ per cent.}$$

The cost of centering is of course increased, and how high a value may be given to the ratio $\frac{d}{b}$ must depend on the circumstances of any individual case, due regard being paid to the necessity of making the member strong enough to resist any accidental moment which may be applied in a lateral direction. Obviously a member 18" \times 2.2" would be too fragile from this point of view.

Case IV. Members reinforced in both tension and compression areas, subjected to combined bending and tension.—Silo walls, and other examples of members under combined bending and tension, are subject to having their moments reversed, and therefore must be reinforced on both sides.

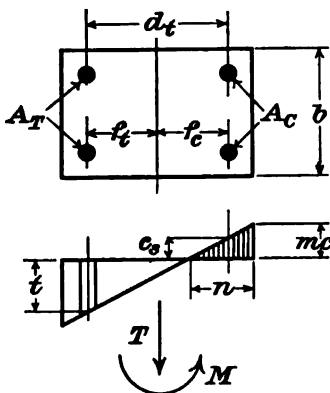

FIG. 26.—Bending and tension with members reinforced on both sides.

In this case, the resistance of the compression side of the member is increased.

(a) *Direct Solution.*—Unfortunately, there are so many variables to this problem that equations applicable to all cases are very cumbersome, and difficult to use when obtained. For this reason, the authors recommend

the use of the indirect solution, given on p. 58, which is applicable to all cases, including unsymmetrically reinforced members, and for any cover of concrete on the bars.

For the sake of completeness, the formulæ forming the basis of the direct solution is here given.

With the notation in Fig. 26, we may write down the following four equations:—

$$T = A_r \cdot t - \frac{nbc}{2} - A_c \cdot c_s$$

$$M = A_r \cdot t \cdot f_t + \frac{nbc}{2} \left(\frac{d_t}{2} - \frac{n}{3} \right) + A_c \cdot c_s \cdot f_c$$

$$t = mc \frac{\left(f_t + \frac{d_t}{2} - n \right)}{n}$$

$$c_s = \frac{mc \left(f_c - \frac{d_t}{2} + n \right)}{n}$$

The first of these is obtained by equating the external force T to the sum of all the internal forces, the second by equating the external moment M to the sum of the internal moments, measured about the centre of section, the third and fourth following at once from the lineal stress diagram.

These formulæ contain so many variables, that the general case cannot be solved directly. Considerable simplification results by confining our attention to *symmetrical reinforcement*, when we may put

$$A_r = A_c$$

$$f_t = f_c$$

With this simplification, the four equations can be combined to give an equation for n , viz.—

$$n^3 - 3n^2 \left(\frac{d_t}{2} + \frac{M}{T} \right) - 12n \left(\frac{M}{T} \cdot \frac{mc}{b} \right) + 6 \frac{t}{b} \left(\frac{M}{T} d_t - 2f^2 \right) = 0$$

It will be seen that this is a cubic equation, which cannot be solved directly. Series of curves can, however, be calculated and drawn from which the solution may be obtained. Such a series must, however, be drawn for a definite value of the cover of the concrete. Prof. Morsch, in *Der Eisenbetonbau*, gives such a series, in which he puts $f = 0.42d$. Messrs. Taylor and Thompson (*Concrete Plain and Reinforced*) give a series in which $f = 0.4d$.

It is obvious that the exact application of the curves is very much reduced after this second simplification, since in practical examples, cases are frequently met with, in which other values have to be adopted. In silo walls, for instance, f is frequently less than $0.4d$.

Thus a 5" wall with $\frac{1}{2}$ " bars and $\frac{1}{2}$ " cover of concrete would have

$$f = \frac{1\frac{3}{4}}{5}d = 0.35d$$

For this reason the curves are not given here, and may be referred to in either of the works mentioned above if required.

(b) *Indirect Solution.*—This is applicable to all cases, including those when A_T differs from A_C , and when the compression and tension steel are not necessarily equidistant from the centre of section (f_c not equal to f_t).

The method consists in treating the section as reinforced in tension only, as in Case II.

The effect of the compression reinforcement is to increase the resistance of the compression side, and may therefore be considered as equivalent to increasing the breadth to such an extent as to produce this same increase of resistance. The following example illustrates the method.

Example 1.—Silo wall 6" thick reinforced with $\frac{3}{8}$ " ϕ bars at 6" centres, $\frac{1}{2}$ " cover of concrete (Fig. 27). Calculate stresses, given that direct tension $T = 2,500$ lbs.

$$M = 25,000 \text{ lb.-ins.}$$

$$\text{Here eccentricity } e = \frac{M}{T} = 10 \text{ ins.}$$

$$\therefore \frac{e - f}{d} = \frac{10 - 2\frac{1}{4}}{5\frac{1}{4}} = 1.475.$$

Considering a width of slab $b = 12$ ", we have—

$$A = 0.614 \text{ in.}^2$$

$$p = \frac{0.614 \times 100}{5\frac{1}{4} \times 12} = 0.975 \text{ per cent.}$$

In accordance with the method as explained above, the first

step is to calculate approximately to what extent the compression reinforcement increases the resistance of the compression side.

For this purpose an approximate value of n must be obtained. Neglecting for the moment the compression rein-

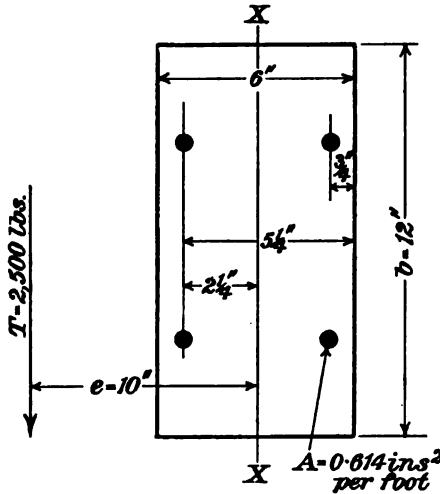

FIG. 27.

forcement, we may obtain from the curve of Fig. 23, given $p = 0.975$ and $\frac{e-f}{d} = 1.475$,

$$t_1 = \frac{t}{c} = 28.2.$$

Hence, from the curve of Fig. 10, $n_1 = \frac{n}{d} = 0.347$

$$\left[\text{or directly } n_1 = \frac{m}{t_1 + m} = \frac{15}{28.2 + 15} = 0.347 \right]$$

$$\therefore n = 0.347 \times 5\frac{1}{4} = 1.82''.$$

Therefore total compression in concrete = $\frac{bnc}{2}$

$$= \frac{12'' \times 1.82 \times c}{2} = 10.9c$$

The stress in the compression steel will be—

$$mc \left(\frac{1.82 - 0.75}{1.82} \right)$$

∴ Increase of compression due to the steel

$$\begin{aligned} &= (m - 1) c \times \frac{1.82 - 0.75}{1.82} \times A \\ &= 14 \times 0.59 \times 614 \times c \\ &= 5.06c. \end{aligned}$$

Hence percentage increase in compression

$$= \frac{5.06 \times 100}{10.9} = 46 \text{ per cent.}$$

We may therefore allow for the compression reinforcement by considering the slab increased in width by this amount, as shown in Fig. 28, and simply solving as for Case II.

Equivalent width of slab $b' = 12 \times 1.46 = 17.6$ ins.

Recalculating the percentage for this revised width—

$$p' = \frac{0.614}{5\frac{1}{4} \times 17.6} = 0.665 \text{ per cent.}$$

Hence, from curve, given $p' = 0.665$ and $\frac{e-f}{d} = 1.475$, we have—

$$t_1 = 35.7$$

and the corresponding value of $d - n/3$, from the curve of Fig. 14 or directly, is $0.901d = 4.725$ ins.;

$$\therefore t = \frac{T}{A} \cdot \frac{(e-f) + \left(d - \frac{n}{3}\right)}{\left(d - \frac{n}{3}\right)}$$

$$= \frac{2,500 \cdot 7.75 + 4.725}{0.614 \cdot 4.725}$$

$$= 10,780 \text{ lbs./ins.}^2$$

and

$$c = \frac{t}{t_1} = \frac{10,780}{35.7} = 277 \text{ lbs./ins.}^2$$

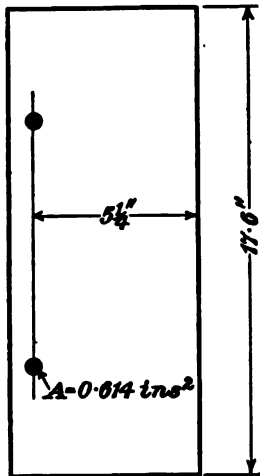

FIG. 28.

This method gives t with considerable accuracy since $(d - n/3)$, the only expression in the formula not directly given, varies very slowly with c_1 . The error will seldom exceed 1 per cent. The error in c may amount to about 5 per cent. in practical examples.

The example has been given in detail to show the method. In practice only a few lines are required. If greater accuracy is desired, a second approximation may be made, taxing t_1 as 35.7 instead of 28.2.

It is interesting to note that if the compression reinforcement were omitted, the stresses would be

$$t = \frac{2,500}{0.614} \times \frac{7.75 + 4.64}{4.64} = 10,890 \text{ lbs./ins.}^2$$

$$c = \frac{10,890}{28.2} = 386 \text{ lbs./ins.}^2$$

which gives an idea of the effect of the compression steel on the stresses. The effect is small on the steel, and considerable on the concrete.

II.—BENDING AND COMPRESSION

Where the moment and the direct compression are known, these may be replaced by the compression acting at a certain eccentricity, e , that is

$$e = \frac{M}{P}$$

where P = compression,

M = moment.

Case I. Where the eccentricity is so small that no tension is developed in the member.*

The eccentricity is to be measured about the centroid of the equivalent section, *i.e.* a section in which any area of steel is replaced by m times its area of concrete.

* Where the section is unreinforced, tension is produced when the eccentricity exceeds $\frac{d}{6}$. When reinforced, the permissible eccentricity lies between

$\frac{d}{6}$ and f (see Fig. 29), in dependence upon the percentage of reinforcement.

In the general case of an irregular area with steel unsymmetrically placed (Fig. 29), we have, for the maximum and minimum concrete stresses—

$$c_1 = \frac{P}{A_x} + \frac{My_1}{I_x} \quad (8a)$$

$$c_2 = \frac{P}{A_x} - \frac{My_2}{I_x} \quad (8b)$$

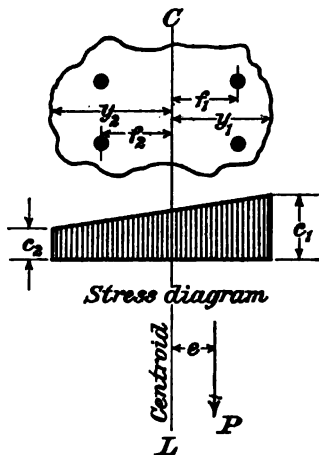

where A_x is the equivalent area, already defined as $A + (m - 1)A_L$, and I_x is the equivalent moment of inertia of the section about its centroid,

$$\text{i.e. } I_x = I_c + (m - 1)I_L$$

where I = the moment of inertia of the concrete,

and I_L = the moment of inertia of the steel.

FIG. 29.—Bending and compression, with small eccentricity.

In the case of a rectangular section symmetrically reinforced (Fig. 30), the centroid is central, and

$$I_x = \frac{bd^3}{12} + (m - 1)A_L f^2$$

Hence the expression for c_1 and c_2 may be written—

$$c_1 \text{ and } c_2 = \frac{P}{A + (m - 1)A_L} \pm \frac{M \cdot \frac{d}{2}}{\frac{bd^3}{12} + (m - 1)A_L f^2} \quad (9)$$

Example.—A column 18" × 12" with 4 - 1½" ϕ bars having 1¼" cover of concrete is subjected to a load of 100,000 lbs., and a bending moment of 200,000 in.-lbs. applied about its shorter axis. Calculate the stresses.

Here $P = 100,000$ lbs.

$M = 200,000$ in.-lbs.

$A = 18 \times 12 = 216$ ins.²

$(m - 1) = 14$.*

$A_L = 4 \times 1.76 = 7.04$ ins.²

* For a more accurate value of m for columns, see p. 104.

$$\frac{d}{2} = 9 \text{ ins.}$$

$$f = 9 - \left(1\frac{1}{4} + \frac{3}{4}\right) = 7 \text{ ins.}$$

$$\therefore c_1 \text{ and } c_2 = \frac{100,000}{216 + 98.5} \pm \frac{200,000 \times 9}{\frac{12 \times 18^3}{12} + 14 \times 7.04 \times 7^2}$$

$$= 319 \pm 172,$$

whence $c_1 = 491 \text{ lbs./ins.}^2$

and $c_2 = 147 \text{ lbs./ins.}^2$

It is interesting to note that the influence of the steel on the stress due to bending is much greater than its influence on the stress due to direct load.

Case II. Where P falls outside the limits of d , Members singly reinforced (see Fig. 31).

$$\left(\text{Values of } \frac{e+f}{d} \text{ up to } 4\right)$$

NOTE.—Members having double reinforcement may be solved by Case IV.

P = total compression; M = external moment. Assume t and c known.

Then
$$n_1 = \frac{n}{d} = \frac{mc}{t + mc}$$

$$\text{total compression} = \frac{nb}{2} \times c$$

$$\text{total tension} = A_T \cdot t,$$

$$\therefore P = \frac{nb}{2} \times c - A_T \cdot t. \quad \dots (10)$$

Taking moments about centre of tension,

$$P(e+f) = \frac{nb}{2} c \times \left(d - \frac{n}{3}\right). \quad \dots (11)$$

Put $M = Pe$, where e is the eccentricity. Dividing (11) by (10),

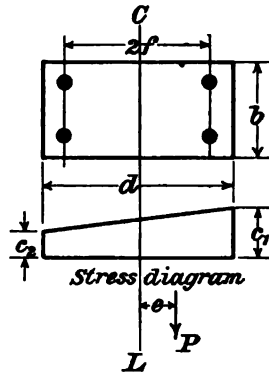

FIG. 30.—Rectangular section symmetrically reinforced under bending and direct compression.

$$-(e + f) = \frac{\frac{nbdc}{2} - \frac{n^2bc}{6}}{\frac{pbdt}{100} - \frac{nbc}{2}} = \frac{(d - \frac{n}{3}) \cdot 50 \cdot \frac{c}{t} \cdot n}{pd - 50 \frac{c}{t} n}$$

It will be seen that the right-hand side is the same as in equation (4a) on p. 48.

If the same substitutions are made, we get—

$$-\frac{(e + f)}{d} = \frac{t_1 + \frac{2}{3}m}{t_1 + m} \cdot \frac{50m}{t_1} \cdot \frac{1}{p(t_1 + m) - \frac{50m}{t_1}} \quad \dots \quad (12)$$

This also is the same expression as was obtained for tension and bending, except that on the left hand we have $-\frac{(e + f)}{d}$

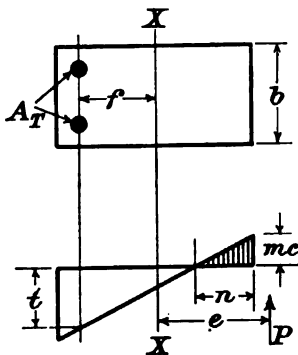

FIG. 31.—Bending and compression, P falling outside *d*.

in place of $\frac{e - f}{d}$. Hence the curves are really continuations of the curves applicable to tension and bending, values of t_1 and p being, however, so chosen that the expression shall be negative instead of positive.

As there is no practical advantage in having the two sets of curves together, and greater accuracy is obtained by keeping them separate and choosing for each the most appropriate scale, this has

been done. The curves between $\frac{e + f}{d}$ and t_1 and p for compression are given in Fig. 32 for $m = 15$, and Fig. 33 for $m = 10$. The use of these curves is exactly similar to that of the corresponding curves for tension (see pp. 50 and 51).

The process of determining the stress in a given member reduces itself to the following. From p and $\frac{e + f}{d}$ —both known quantities—find t_1 from the appropriate curve. From t_1 , $a = d - n/3$ can be found from Fig. 14.

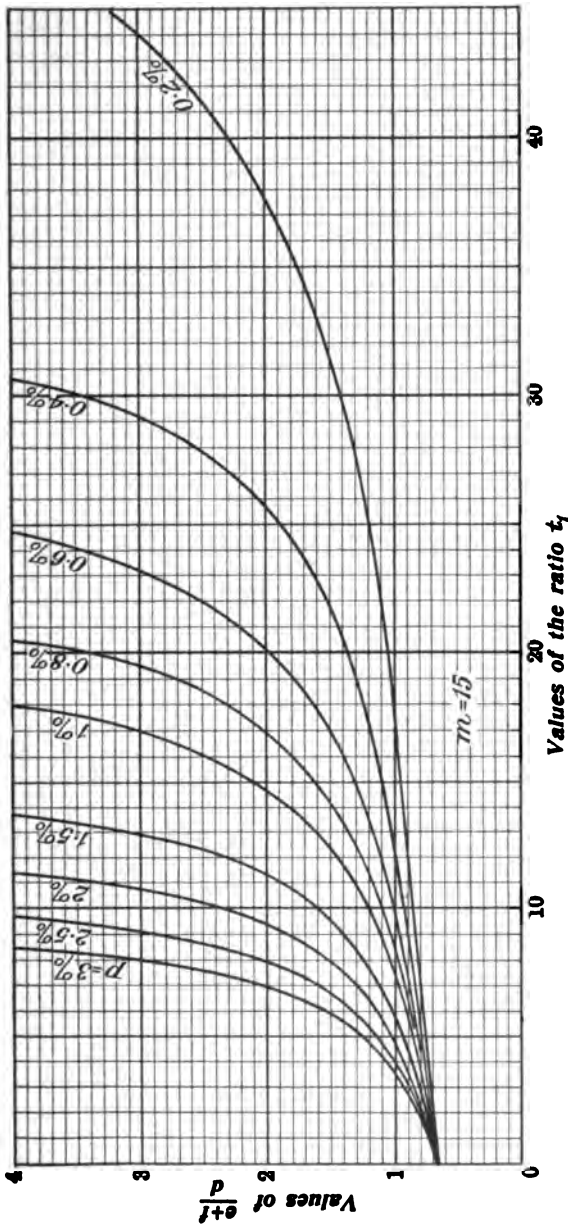

FIG. 32.—Values of $\frac{e+f}{d}$ for various values of t_1 and p . $m = 15$.

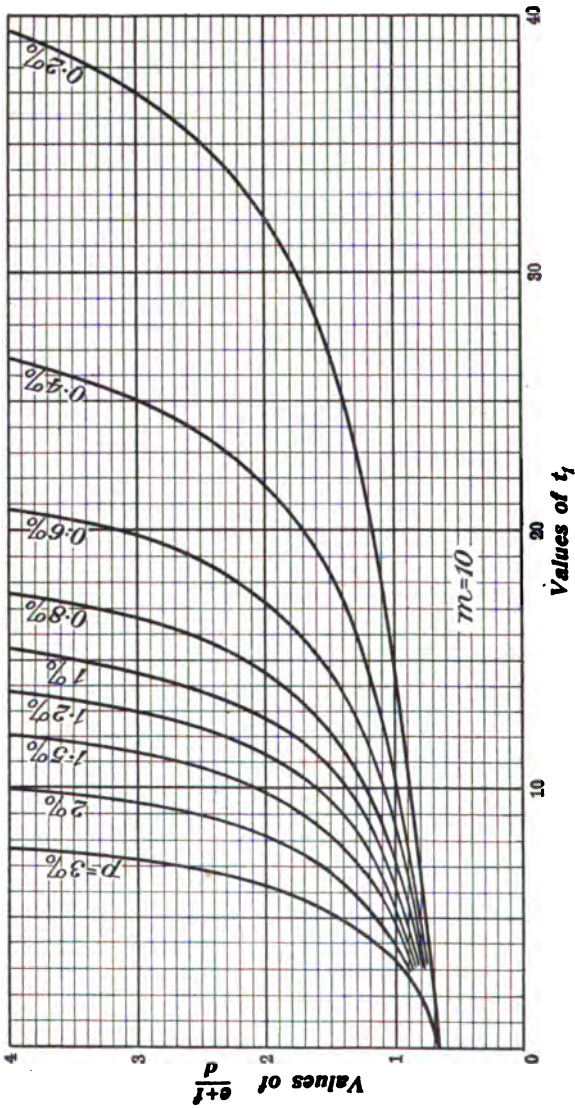

FIG. 33.—Values of $\frac{e+f}{d}$ for various values of t_1 and p . $m = 10$.

If we multiply equation (10) by $d - n/3$ and subtract from (11), we have—

$$P\left\{(e + f) - \left(d - \frac{n}{3}\right)\right\} = At\left(d - \frac{n}{3}\right)$$

whence
$$t = \frac{P}{A_r} \cdot \frac{(e + f) - \left(d - \frac{n}{3}\right)}{\left(d - \frac{n}{3}\right)} \dots (13)$$

$$= \frac{P}{A_r} \cdot \frac{(e + f) - a}{a} \dots (13a)$$

and
$$c = \frac{t}{t_1}$$

Example.—Let $A_r = 0.614 \text{ ins.}^2$

Then
$$p = \frac{0.614 \times 100}{60} = 1.02 \text{ per cent.}$$

Let $P = 800 \text{ lbs.}$

and $M = 28,000 \text{ lb.-ins.}^2$ about the line XX (Fig. 34).

Then
$$e = \frac{28,000}{800} = 35 \text{ ins.}$$

$$e + f = 40 \text{ ins.}$$

$$\frac{e + f}{d} = \frac{40}{10} = 4,$$

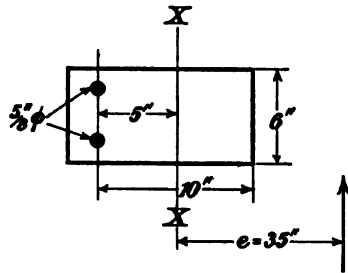

FIG. 34.

and the case is on the boundary between Cases II. and III.

From these values of p and $\frac{e + f}{d}$ we get, from Fig. 32, $t_1 = 18$, and by reference to Fig. 14 we have $a_1 = 0.85$, and therefore $a = a_1 d = 0.85 \times 10 = 8.5 \text{ ins.}$

Hence from equation (13a)—

$$\begin{aligned} t &= \frac{P}{A_r} \cdot \frac{(e + f) - a}{a} \\ &= \frac{800}{0.614} \times \frac{40 - 8.5}{8.5} \\ &= 4820 \text{ lbs./ins.}^2 \end{aligned}$$

and
$$c = \frac{4820}{18} = 268 \text{ lbs./ins.}^2$$

Case III. Where P falls far outside the limits of d .—
(Values of $\frac{e+f}{d}$ greater than 4). Approximate method.

In this case the effect of the direct compression is so small, that it is sufficiently accurate to calculate the stresses for the bending moment alone, and then to allow for the direct compression by increasing the concrete stress by $\frac{P}{bd}$ and reducing the tensile stress in the steel by $\frac{P}{2A_T}$, where A_T is the area of steel on the tension side.

Example.—The example worked out above lay on the boundary between Cases II. and III., since $\frac{e+f}{d} = 4$. Hence we may now work it out by the method of Case III. and compare the results.

Since $p = 1.02$ per cent., we have, from Fig. 13—

$$a = 0.86 \times 10 = 8.6''.$$

$$\text{whence } t = \frac{M}{A_T \times a} = \frac{28,000}{0.614 \times 8.6} \\ = 5290 \text{ lbs./ins.}^2$$

From Fig. 10 we have $n = 0.42 \times 10 = 4.2''$;

$$\text{whence } c = \frac{2M}{bn \times a} = \frac{2 \times 28,000}{6 \times 4.2 \times 8.6} \\ = 258 \text{ lbs./ins.}^2$$

$$\text{Increasing } c \text{ by } \frac{P}{bd} = \frac{800}{6 \times 10} = 13.3 \text{ lbs./ins.}^2$$

$$\text{and reducing } t \text{ by } \frac{P}{2.A} = \frac{800}{1.228} = 650 \text{ lbs./ins.}^2$$

we have, for final values—

$$c = 258 + 13 = 271 \text{ lbs./ins.}^2$$

$$t = 5290 - 650 = 4640 \text{ lbs./ins.}^2$$

It will be seen that these results agree well enough with those obtained accurately by the method of Case II., and the accuracy of the method of Case III. increases with increasing value of $\frac{e+f}{d}$, the example taken being the lowest value for which its use is advocated.

Case IV. Application of Cases II. and III. to members having double reinforcement.

The method followed is exactly the same as that advocated for the corresponding problem for combined bending and tension. (See p. 58.)

From a trial value of the position of the neutral axis, the value of the compression reinforcement may be determined, and is expressed by considering the width of the beam increased to the corresponding extent. The corrected value of p for this increased width is then obtained, and the solution proceeds as for Cases II. or III.

Example.—The same example as in Fig. 34 will be taken, with the difference that 2 — $\frac{5}{8}$ " bars are inserted in the compression side (Fig. 35).

The previous value of n was 4.6 ins., and as the effect of the compression steel must be to move the neutral axis towards the compression face, we will take a trial value of $n = 4$ ins. Since the steel lies halfway between the neutral axis and the compressed edge, its stress will be $\frac{c}{2} \cdot m$.

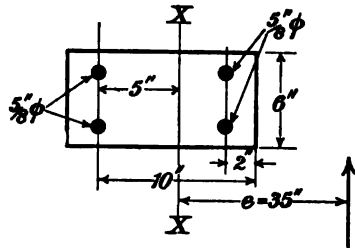

FIG. 35.—Bending and compression with members doubly reinforced.

$$\text{Total compression from concrete} = \frac{nb\bar{c}}{2} = 12c$$

$$\begin{aligned} \text{Additional compression from steel} &= \frac{c(m-1)}{2} \times A_c \\ &= \frac{c(15-1) \times 0.614}{2} \\ &= 4.3c. \end{aligned}$$

Hence the value of the compression reinforcement is equivalent to increasing the width of beam to

$$6 \times \frac{16.3}{12} = 8.15 \text{ ins.}$$

$$\text{Hence } p_1 = \frac{0.614 \times 100}{10 \times 8.15} = 0.75.$$

The calculations may now be completed as before.

Following the method of Case II., we have for

$$\frac{e+f}{d} = 4, \text{ and } p_1 = 0.75$$

and

$$t_1 = 21.3 \text{ from Fig. 32,}$$

$$a = 8.6''.$$

Therefore

$$t = \frac{P}{A} \cdot \frac{(e+f) - a}{a}$$

$$= \frac{800}{0.614} \times \frac{40 - 8.6}{8.6} = 4750 \text{ lbs./ins.}^2$$

and

$$c = \frac{4750}{21.3} = 223 \text{ lbs./ins.}^2$$

Comparing these results with those obtained for the same beam without compression reinforcement (4820 and 268), it will be seen that the steel stress is reduced very slightly, and the concrete stress considerably, by the addition of the compression reinforcement.

It may be noted that the value of n_1 , after this first approximation, is 0.41, which agrees sufficiently well with that assumed—0.40.

CHAPTER IV

ADHESION AND SHEAR

ADHESION

If a rod be embedded in a block of concrete and be made to support a weight, as in Fig. 36, the adhesion over the whole surface embedded must equal the weight supported. If we assume the adhesion constant at all points on the surface, it has the average value

$$f = \frac{W}{A}$$

where A is the area of embedded surface.

A little consideration will show that in the arrangement of Fig. 36 the adhesion is not constant, being greater near the bottom of the block than at the top; for, owing to the elongation of the bar under tensile stress and the vertical shortening of the concrete under compressive stress, there will be a relative movement between the steel and concrete at the bottom before the top moves.

The nature of the adhesion is important. If a small plate of iron or steel be left in contact with newly mixed concrete on one face only, it is found that practically no adhesion is obtained, whereas if embedded in a block of concrete, the adhesion may be 300 lbs./ins.² It follows that the adhesion is not similar to that with which glue sticks two pieces of wood together.

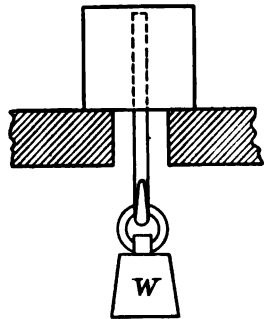

FIG. 36.—Adhesion.

When concrete sets in air a considerable contraction of volume occurs, and when it sets round a rod, pressure is exerted on the sides of the rod, this pressure being produced by circumferential tension in the surrounding concrete.

When concrete sets under water, as in some cases of dock construction, etc., expansion of the concrete may take place, and under these conditions the adhesive strength of plain bars would be very small.

Adhesion is to be considered as the friction between the two surfaces, and will therefore depend upon the nature of the

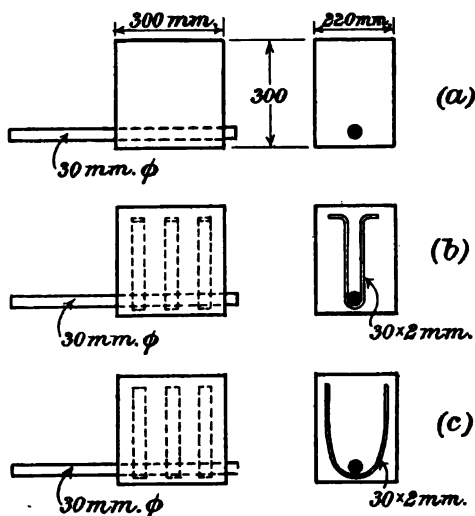

FIG. 37.—Adhesion tests.

surfaces and the magnitude of the normal pressure. From this, we may expect good adhesion to be obtained under the following conditions:—

(a) Roughness of surface.

The relative adhesions for bright steel, steel as rolled, and very rusty steel are approximately * as—

$$1 : 1.74 : 2.50.$$

(b) Rich concrete, since the tensile strength and the contraction increase with the proportion of cement.

* *Mitteilungen über Forschungsarbeiten, Verein deutscher Ingenieure, Heft. 72-74.*

(c) Ample cover of concrete round the bars.

Since the tensile strength of concrete is small, failure of an adhesion test specimen often occurs by the splitting of the block. Obviously the larger the block, the greater the force required to split it. This factor has an important bearing on the permissible adhesion in practice, for whereas test specimens frequently have a cover of concrete of three or four times the diameter of the bar, in practice this is on one side at least rarely more than twice the diameter. This applies particularly to the merits of bars provided with a mechanical bond; these undoubtedly give increased adhesion when given plenty of binding or a very large cover of concrete—a condition generally prevailing in tests for adhesion. When the failure of the specimen occurs by splitting of the block, as occurs with small covers of concrete, the value of a mechanical bond would appear to be small.

(d) Binding round the rods, for the same reason as (c).

Thus the French Commission found that the ultimate adhesion in certain beams was increased from 125 lbs./ins.² in Fig. 37*a*, to 252 lbs./ins.² by stirrups as in Fig. 37*b*, and to 284 lbs./ins.² by stirrups, as in Fig. 37*c*, the specimens being three months old.*

It is obvious that where so many factors influence the adhesion to such an extent, there is no object in giving results with great refinement. Where, however, the possibility of splitting of the concrete is prevented by adequate cover of concrete or by binding, an ultimate adhesion of 250 lbs./ins.² may be expected from good 1 : 2 : 4 concrete at the age of one month, when commercial steel with a slightly rusted surface is used.

The working stress recommended by the R.I.B.A., 1911, is 100 lbs./ins.² This would appear to give a low factor of safety, but the recommendation is qualified by the clause, "Precautions should in every case be taken by splitting or bending the rod ends, or otherwise to provide additional security against the sliding of the rods in the concrete"—a precaution which, in the authors' view, is most necessary.

A simple expression may be obtained for the "grip length"

* *Commission du Ciment Arme.* Paris, 1907.

of a round bar, the grip length being that length of embedment at which the working adhesion and working tensile strength are reached simultaneously.

$$\text{Resistance to tension} = t \times \frac{\pi}{4} d^2$$

$$\text{Resistance to drawing} = f \cdot \pi \cdot d \cdot l.$$

where f is the safe adhesion stress.

Hence, when l is the grip length, these will be equal, whence

$$l = \frac{t}{f} \cdot \frac{d}{4}.$$

If t is taken as 16,000 and f as 100, this reduces to

$$l = 40d.$$

The authors would increase this to $l = 48d$ where possible.

An important application is that of "laps." In a cylindrical tank, for example, the pressure of the water is resisted by circumferential tension in the sides of the tank. As the circumference is generally of greater length than it is convenient to make the bars, these have to be in several lengths, and an adequate joint between their ends has to be made. It will be seen from the above that if the bars are lapped past one another for a length of $40d$, this, according to many authorities, should be safe. The authors do not, however, consider that such a joint gives a

sufficient factor of safety.*

There is but little information about the effect of time, shock, percolation, etc., on the circumferential tension in the concrete round the bars, and the authors would certainly provide binding and adequate hooks at the ends of the bars, in addition to an adequate bond length.

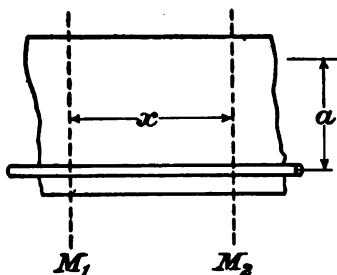

FIG. 38.

Calculation of adhesion stresses in beams.

Consider two sections of a beam, at a small distance apart, x , at which the moments are M_1 and M_2 respectively (Fig. 38).

* Such a failure as that of the Australian reservoir in January, 1909, reported in *Proc. Inst. C.E.*, vol. cixxx., would seem to confirm this. See also p. 212.

The tension in the bars at the two sections will be $\frac{M_1}{a}$ and $\frac{M_2}{a}$ respectively, and hence the difference of tension at the two points, which has to be taken up, is

$$F = \frac{M_1 - M_2}{a}.$$

As the area of adhesion surface between the two planes considered is $n\pi dx$, n being the number of bars, and d their diameter, the mean adhesion stress will be

$$f = \frac{F}{n\pi xd} = \frac{M_1 - M_2}{n\pi xad}$$

Now, the expression $\frac{M_1 - M_2}{x}$, being the rate of change of bending moment, is S , the total shear on a vertical section, whence

$$f = \frac{S}{(n\pi d)a},$$

the expression $n\pi d$ being the sum of the perimeters of the bars.

It will be seen from this that the adhesion varies directly with the shear, and may therefore easily be calculated for any given loading.

As it is assumed that the calculation of the total shear on a section of a beam or slab presents no difficulty, this will not be pursued further.*

If the depth of the beam is a variable, the adhesion will be affected, since the stress in the steel is given by $\frac{M}{a}$. Putting a_1 and a_2 for the moments of internal forces in the beam at the two sections, we have

$$F = \frac{M_1}{a_1} - \frac{M_2}{a_2}$$

$$\text{and } f = \frac{\frac{M_1}{a_1} - \frac{M_2}{a_2}}{n\pi dx}.$$

* The student may, however, refer to pp. 115 and 156 for a few notes on shear as affected by continuity.

In such cases, solution is best obtained by calculating values for M_1 and M_2 at two points some small distance apart— $x = 12$ ins. for example—and obtaining a_1 and a_2 by reference to the drawing. For this purpose, it is generally sufficiently accurate to take a as 0.88 of the depth of the beam.

It is obvious that the adhesion, varying as it does with the shear, will be a maximum at the supports of a beam. Hence it usually suffices to calculate it at these points. It generally happens that some of the bars are bent up, and are then not available to resist adhesion stresses. Thus in Fig. 39 the number of bars available for the calculation of the adhesion would be two, and not six.

The calculation of adhesion, though simple according to the analysis given, may be greatly complicated under different

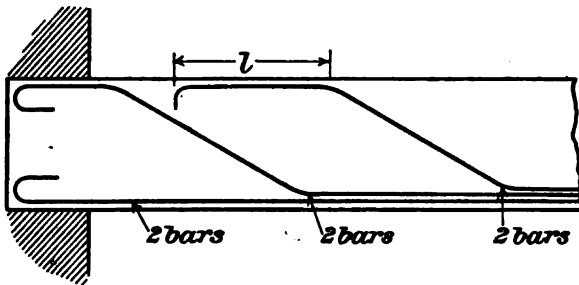

FIG. 39.—Adhesion at supports of beam.

arrangement of bars, and especially owing to the formation of "diagonal compression forces" in the concrete, which are dealt with later. These problems are, however, so complicated that they cannot be given here, especially as their solution has generally to be considered individually, without the derivation of formulæ generally applicable.

Where bent-up bars are assumed to be in full tension for the whole of their inclined length, it is necessary that, as shown in Fig. 39, sufficient length l should be provided beyond it to develop this tension without incurring excessive adhesion stresses.

In the calculation of this length, the bond stress may be assumed constant.

In the calculation of adhesion stress in stirrups it is generally sufficient to take the length of stirrup above the neutral

axis to be in constant adhesion. It must be remembered, however, that in that case the tension in it will also fall off uniformly above this point, which is generally not quite what is assumed in calculating their resistance to shear. In any case, a hook or bend over a top bar is always desirable for adequate fixing.

Hooks and Bends.

It is important that the bends in bars be not too sharp, or excessive compression stress in the concrete will be produced which sometimes causes the beam to split longitudinally. Considering a semicircular arc, as in Fig. 40, it will be seen that $2T = cd_1 \cdot d_2$, where T = tension in bar, c = compression stress in concrete, d_1 = internal diameter of bend, and d_2 = diameter of bar.

Putting
$$T = t \times \frac{\pi d_2^2}{4}$$

$$t \cdot \pi \cdot d_2^2 = 2c \cdot d_1 \cdot d_2$$

or
$$d_1 = \frac{t\pi d_2}{2c}.$$

If we put $c = 800$ lbs./ins.², and $t = 16,000$ lbs./ins.², this reduces to $d_1 = 31.4d_2$.

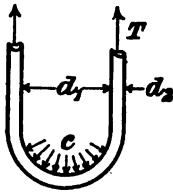

FIG. 40.

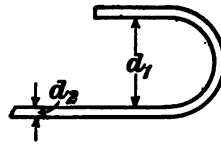

FIG. 41.

This proportion should be maintained approximately where possible. Where it is not possible, and a sharp bend is necessary, the danger of splitting is greatly reduced by the insertion of pins in the bend, especially if the ends of these pins are bent or fishtailed.

In the case of the hooks at the end of the straight bars at the bottom of the beam, Considère recommends (see Fig. 41)

$$d_1 = 5d_2.$$

This case is not quite analogous to that given above, since

tension is applied to one end of the bar only, and is taken up in friction between the steel and concrete round the bend. In the opinion of the authors, although

$$d_1 = 5d_2$$

may be sufficient to develop the elastic limit of the steel when embedded in a large block of concrete where the resistance to splitting is considerable, it is hardly sufficient with the small amount of cover frequently given in beams, in cases when the steel is fully stressed right up to the hook.

The tendency to split the concrete is best resisted by binding or by small bars with bent-up ends, placed in the bend. They must, of course, be securely wired, to prevent derangement during the process of concreting.

In connection with the use of such hooks, it should be noticed that the resultant of the resisting forces is not con-

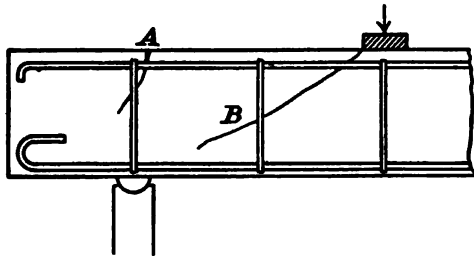

FIG. 42.—Crack due to eccentricity of resistance of hook.

centric with the bar, and consequently a bending moment is produced which may be dangerous in some cases. Thus some test beams constructed at the Northern Polytechnic Institute,



FIG. 43.—Hook too near surface.

London, showed (Fig. 42), in addition to the shear crack B, a crack A which is at least partly due to this secondary moment produced by the eccentricity of the resistance of the hook. In

no case should the end of the hook be placed near the surface of the concrete, except where it is well bound, since failure will occur by spalling of the concrete, as in Fig. 43.

SHEAR.

If a beam or similar member is subjected to an external shearing force, internal stresses are produced, which are sometimes called shearing stresses; they are, however, generally

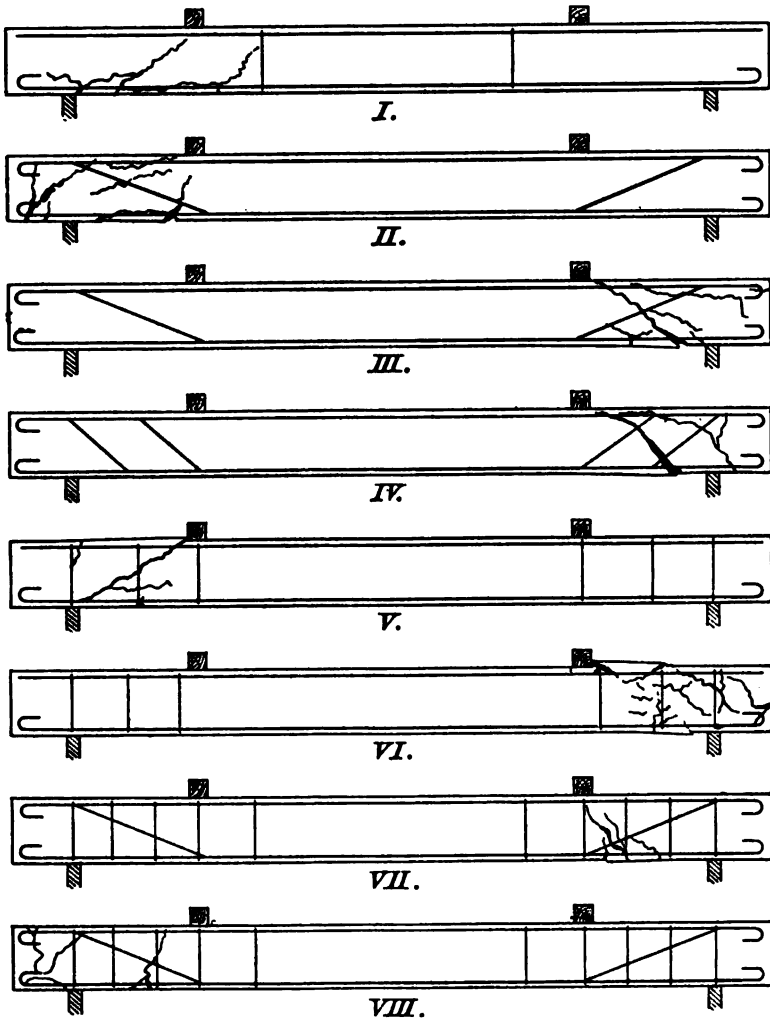

FIG. 44.—Beams tested at Northern Polytechnic Institute, 1910 series.

very complex, and are to be distinguished from the shear stress produced in a punching machine, for instance.

For this reason, the former stresses should be referred to as "secondary stresses due to shear." Except when a large number of diagonal or vertical stirrups or bent-up bars is provided, such secondary stresses will produce failure by tension along diagonal planes, and are therefore sometimes called diagonal tension stresses. This term is not so good, since failure does not always occur in this manner.

Examples of failure by diagonal tension are given in Fig. 44, which shows some beams constructed and tested at the Northern Polytechnic Institute in 1910.

Consider a small square element in the web of a beam subjected to shear (Fig. 45). The vertical shear in the beam produces a shearing stress s_1 on vertical planes. If these were the only forces acting on the element, it would rotate. To

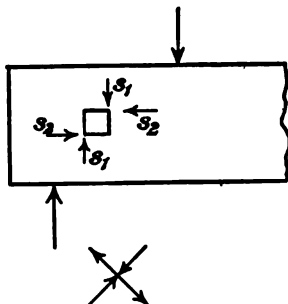

FIG. 45.—Analysis of shear stresses.

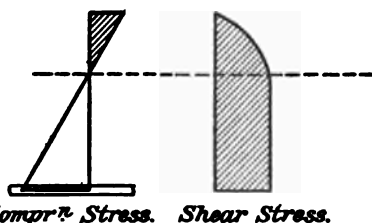

FIG. 46.—Distribution of shear stress across a vertical section of a R. C. beam.

keep it in equilibrium, there must be an equal shear stress s_2 on the horizontal planes.

If these shear stresses are combined, it will be seen that they are equivalent to a principal compressive stress on one diagonal plane and a principal tensile stress on the other, *both stresses being equal in intensity to the shear stress.*

Since concrete is far weaker in tension than in either compression or shear, it tends to fail along the tension plane.

When beams are not reinforced for shear, the safe shear stress will be determined by the safe tensile stress in concrete.

The usual value for this is 60 lbs./ins.², for best 1 : 2 : 4 concrete. The maximum stress is to be taken over an area $b \times a$, and not over the area bd , since the shear is not constant over the whole section, but diminishes above the neutral axis, as in Fig. 46.

Then safe shear $S = s \cdot b \cdot a$, s being taken at 60 lbs./ins.²

It will be noticed, in passing, that if the tensile strength of concrete were neglected in the calculation of such secondary stresses, no beam without bent-up bars or stirrups would be capable of resisting shear, except in so far as the beam can act as an arch. In floor slabs, the concrete is, however, generally relied upon.

It is necessary to point out that the main tensile reinforcement running horizontally along the bottom of a beam does not add directly to the shear resistance. It may be asked, for

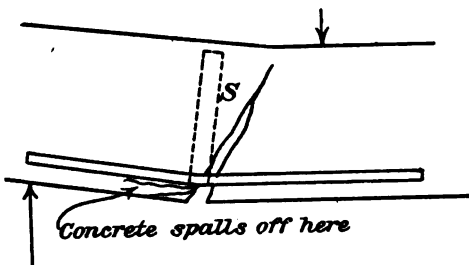

FIG. 47.—Spalling of concrete at under side of beam.

instance, how the beam can shear through a vertical or oblique section without shearing through the steel. The answer is to be found in the fact that the steel is generally close to the under side, and when subjected to any shear, spalls off the concrete cover on the side nearest the support, as in Fig. 47.

It is obvious that if a stirrup, shown dotted at S, had prevented this, the shearing resistance of the steel bars would have added something to the safe shear.

It should be added that failure by shear of members not provided with bent-up bars or stirrups is particularly dangerous, as it generally occurs quite suddenly without any warning.

Shearing resistance of beams with bent-up bars.

When part of the reinforcement is bent up near the end of the beam, as in Fig. 48, it will cut the planes of diagonal tension,

and add considerably to the shearing resistance. If θ is the inclination of the bar to the horizontal, and T the tension in the bar, the shearing resistance due to the bar will be

$$S = T \sin \theta.$$

As regards the value of T , an analysis of experiments shows that T may be taken as the safe tension in the steel (area \times safe stress), *provided the bar is adequately bonded at both ends*. Thus, at a section AA, at which l exceeds the grip length, T may be taken as the safe tension. At the section BB, however, the tension will be very small, and limited by the adhesion on the small length of bar beyond.

The desirability of a hook at the end of a bent-up bar will therefore be apparent in many cases. In continuous beams,

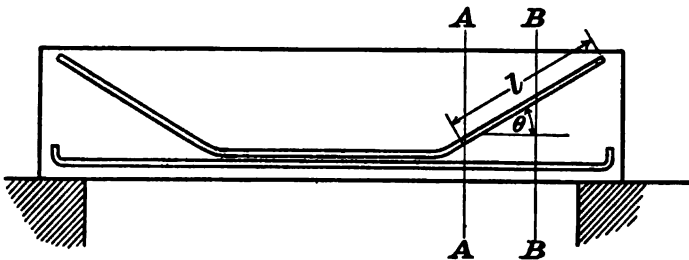

FIG. 48.—Shearing resistance with bent-up bars.

the bent-up bar will generally continue in a horizontal direction over the point of support, and may in that case be assumed to be fully stressed.

It is important to notice, however, that when the steel is stressed to 16,000 lbs./ins.² the concrete will be stressed far beyond its ultimate * stress, and will have cracked. The tensile strength of the concrete across diagonal planes will therefore be lost. In test beams having bent-up bars, it is found that visible cracks occur across diagonal planes long before the ultimate resistance is developed, showing clearly that the concrete in tension is not taking part of the shear.

Hence, when the steel is stressed to the usual stresses, its

* This follows at once from the ratio of the moduli of elasticity. The cracks are generally so small as to be invisible at this stress.

vertical component must equilibrate the whole shear, except so far as this is effected by inclined compressions,* and is not to be added to the shear resistance of the concrete, as is sometimes erroneously done. In other words, when the concrete is not capable of resisting the shear alone, the steel must be designed to take the whole shear.†

Apart from these technical considerations, it is found in practice that, however carefully a foreman is instructed as to where and how joints in the concrete are to be made between two consecutive days' work, it is almost impossible to guarantee that joints will not be made along planes of diagonal tension, and hence the desirability of making the steel sufficient to take the whole shear is further apparent.

There are, however, conditions in which the shear resistance of a beam is considerably increased from other considerations. Take, for instance, Fig. 49.

If the load be applied at a point near the support, a truss action is developed in which an inclined compression stress is produced. The safe shear across the section AA would then be the vertical component of this inclined compression, and may be very considerable, even when no shear reinforcement is provided.

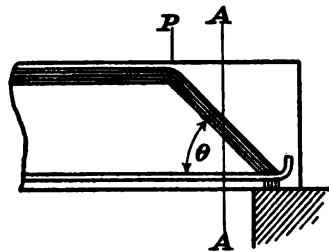

FIG. 49.—Shearing resistance of beam.

It will be seen that the further the point of application recedes from the support, the smaller becomes the angle θ and the greater the inclined compression, for a constant value of the load. The minimum value of θ is determined by the two considerations, that

(a) the inclined compression must not be so great as to produce excessive compression stress in the concrete, or excessive

* This is dealt with later.

† An alternative method of calculation would be to take the concrete into account, and only consider the tension stress in the steel to have a low value which would not overstress the concrete. Taking t as 60 lbs./ins.² and $m = 15$, this will limit the steel stress to $60 \times 15 = 900$ lbs./ins.² Hence, except for very small percentages of shear reinforcement, a higher value of the shear resistance is obtained by neglecting the concrete, and fully stressing the steel.

tensile stress in the straight bars in the bottom of the beam, which for this purpose act merely as a tie; and

(b) the steel must not slip in the concrete.

The second of these considerations will generally limit the value of θ , and will therefore be considered first.

It will be noticed at once that when the inclined compression is taken into account, as is here suggested, the bond stress in the bar becomes very different from that as generally calculated.

Referring back to Fig. 49 again, it will be seen that the bond stress, instead of being constant between the load and the support, will be small until the bar intersects the inclined compression in the concrete.

The horizontal component of the inclined compression has to be resisted by the short length of bar beyond the edge of the support, and generally it will be found that on this length the adhesion will be excessive, but it must be remembered that the safe value is greatly increased in this particular place by the normal component of the inclined compression acting across the bar.

Taking P as the shear resisted by the inclined compression, the tension in the steel due to it is

$$T = \frac{P}{\tan \theta}$$

and the friction of the bar, where it passes through the inclined compression,

$$F = \mu P,$$

where μ is the coefficient of friction between the concrete and the surface of the steel bar.

Neglecting any adhesion which may exist apart from that produced by the vertical pressure, we may equate T and F ;

$$\therefore \frac{P}{\tan \theta} = \mu P$$

$$\text{or } \tan \theta = \frac{1}{\mu}$$

Taking μ for steel rods and concrete as 0.5, it will be seen that so long as θ is not less than $\tan^{-1} 2$ (about 63.5°) there

is no question of slipping, provided the bars pass through the inclined compression. When, however, θ is less than $\tan^{-1} 2$, the difference between the horizontal pull and that taken by the friction due to the inclined compression has to be taken up by adhesion, or by some mechanical fixing such as a hook.

$$\text{Total adhesion} = P(\cot \theta - \frac{1}{2}).$$

Hence, the better the fixing of the ends of the bars *beyond the support*, the more inclined may the diagonal pressure be without causing failure, and such fixing should be provided wherever possible.

The effect of the foregoing has an important bearing on the manner in which the bent-up bars in beams are disposed.

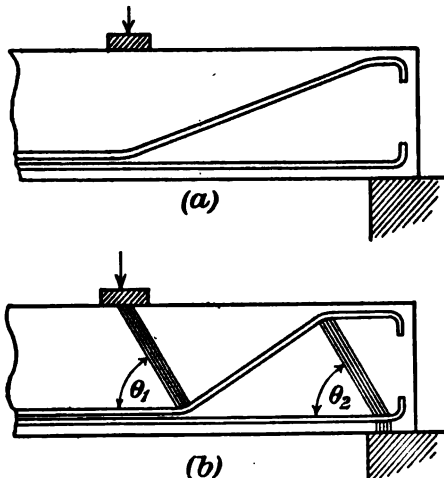

FIG. 50.—Best disposition of bars to resist shear.

Referring to Fig. 50, and comparing (b) with (a), it will be seen that the inclination of the bar has been greatly increased, and its value in shear increased proportionately. The angles θ_1 and θ_2 may generally be taken as 45° (instead of 63.5°), since bends of the bent-up bar and the hook at the end of the straight bar generally provide the additional adhesion,

$$P(\cot 45^\circ - \frac{1}{2}) = \frac{P}{2},$$

required to justify this angle.

Shearing resistance of beams with stirrups.

The action of stirrups in resisting shear in a beam is to be understood from the principle of the formation of inclined compression forces in the concrete which has already been explained.

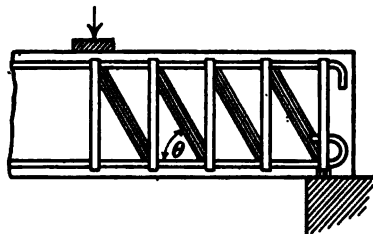

FIG. 51.—Shearing resistance of beams with stirrups.

It will be found that the stress in the stirrups—which is almost pure tension, and not shear as still occasionally stated—and the efficiency of any arrangement of stirrups depend entirely on the angle

θ as before. The limiting value of this angle is determined by the consideration that the horizontal component of the inclined compression has to be taken up by the bars without causing slipping, it being remembered, however, that in addition to the adhesion, the friction due to the vertical component of the inclined compression will resist this slipping. The angle 63.5° for θ is always safe, if μ between the bar and the stirrup may be taken as 0.5. When the adhesion of the bar in the concrete is taken into account, a lower value of θ is justified, and in many cases

$$\theta = 45^\circ$$

is a safe value.

If $\theta = 45^\circ$, it will be seen that when the pitch of the stirrups is equal to the radius arm of the beam a , the tension in each stirrup is equal to the shear resisted. When the stirrups are spaced closer, the tension in the stirrups for a constant value of the shear will be reduced proportionately. The stirrups should not be spaced further apart than the effective depth of the beam, since for them to be effective at all under such conditions, it is necessary to assume so low a value of θ that slipping will be produced.

It is very important to notice that the value of stirrups in resisting shear in a beam, according to the principles explained above, is only justified when the stirrups are adequately fixed to both the tension and compression members. In many arrangements this condition does not obtain. Thus referring

to Fig. 52, it will be found that stirrups (*a*) do not fulfil this condition, since the adhesion of the stirrup would not develop the working tension for some considerable distance from the centre of compression. Where the slab above the beam is loaded on both sides, a compression *C* is produced by the reverse moment above the beam, which certainly increases the fixing of the stirrups considerably in virtue of the friction produced. Generally, however, it is desirable to give the stirrup sufficient anchorage without help from this cause, as a concentrated load may come upon the beam when the slabs

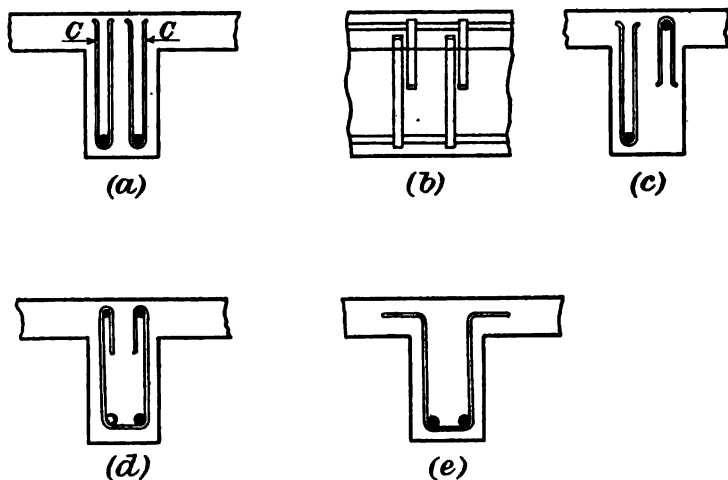

FIG. 52.—Arrangement of stirrups as affecting resistance to shear.

are not loaded. Where stirrups of type (*a*) are used, the full value of the resistances to shear according to the principles given above should not be taken, but a percentage only, which may be as low as 0.6 depending upon the ratio of length to diameter of the stirrups. This objection may be overcome by adding inverted stirrups, as at (*b*) and (*c*), in which case the bond between the two stirrups must be sufficient to develop the full tensile strength of the material. When this is done, the two stirrups are equivalent, statically, to a complete loop.

The stirrup shown at (*d*) is good, and may be assumed as

fully effective when adequate bearing is provided by the top and bottom bars.

The stirrups at (e) are not so good, since excessive compression in the concrete is produced under the upper bends.

Action of a combination of stirrups and bent-up bars in resisting shear in a beam.

It is thought that no great difficulty will be experienced in the application of the foregoing principles to the combination of the two systems. There are, however, a few points which require attention.

Consider, for instance, Fig. 53, in which the two systems are combined.

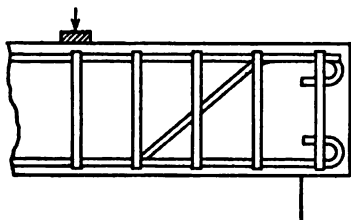

FIG. 53.—Combination of stirrups and bent bars in relation to shear.

If the material is considered to be homogeneous, it is obvious that when the principal compressive stress is as assumed

(θ between 63° and 45°), there is no theoretical justification for assuming a stress of 16,000 lbs./ins.² in the direction of the bent-up bar, and *at the same time* in the vertical stirrups.

On the contrary, an analysis of experiments shows that in many cases when stirrups and bent-up bars are combined, the stress in the stirrups is considerably less than that in the bent-up bars for working loads. For this reason, if the bent-up bars are stressed to 16,000 lbs./ins.², a lesser stress should be taken in the calculation of the additional shear resistance due to the stirrups. The exact value of this stress will depend on the angle at which the bars are bent up, and it must be admitted that all the conditions affecting this question are not perfectly understood. A stress of 8000 lbs./ins.² in the stirrups appears, however, to be always justifiable.

Effect of haunches in reducing the effect of shearing forces.

From many considerations it is generally desirable to provide a haunch to beams at their points of support. This haunch has an important influence on the shearing stresses in the beam. It is obvious that the area of the beam in shear is increased towards the end of the beam where the shear

is greatest. A much more important factor, however, is the inclination of the compression flange force C , due to the negative bending moment at the point of support. When the haunch is a gentle one, as in Fig. 54, it may be assumed that this compression will have the same direction as the haunch.

The vertical component of C at any point may be subtracted from the shear to be resisted. It must, however, be borne in mind that the value of C to be used in the above calculation is to be obtained from the smallest bending moment at the support consistent with the conditions producing heavy shear. In Fig. 54, for instance, the maximum shear across AA occurs when the right-hand bay is fully loaded, but the left-hand bay may be unloaded, and under such conditions the

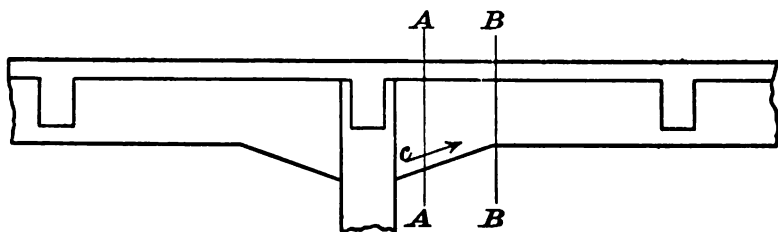

FIG. 54.—Haunches as reducing shearing forces.

reverse moment over the column, and therefore the flange force C , may be small.*

When the shear is practically constant for a considerable distance along the beam, as frequently occurs, particularly with main beams on which the secondary beams form point loads, this inclined compression does not come into play except near the column. At the section BB , for instance, at which the shear may be as great as at AA , there will be tension below the neutral axis, and therefore in this portion of the beam, stirrups and bent bars must take the whole shear.

When the haunch is small, as in Fig. 55, no allowance should be made for this effect.

* The actual value in any particular case is not simply determined. This will be treated under continuous beams (p. 156). Suffice it to say here that it depends chiefly on the ratio of live to dead load.

In connection with the design of members for shear, a practical consideration should deter the designer from cutting things too fine. It must be remembered that failures by shear are generally more sudden than failures by bending, and therefore more dangerous. Further, although the position of the main bars can generally be as-

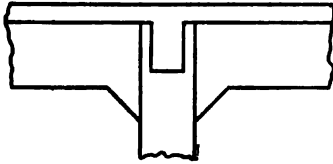

FIG. 55.—Small haunches.

ured with some accuracy, it is very difficult to ensure that the position of the bends will be exactly kept, since, apart from the inaccuracies in arranging the steel in the forms, some derangement not infrequently occurs during the process of concreting. When it is remembered what a great difference in the shear resistance may be caused by the displacement of six inches of a stirrup or a bend, it will be realized how important it is that all stirrups should be wired before concreting, and also that both stirrups and bends should be placed rather closer than actually calculated. For this reason it is advisable to design a beam with θ rather greater than theory indicates, to allow to some extent for such displacements.

Shear in slabs of T-beams.

It was pointed out on p. 39 that the available width of slab for the compression member of a T-beam is largely governed by considerations of shearing stresses in the slab. The authors therefore offer the following considerations on such stresses:—

In a freely supported T-beam, shown in plan in Fig. 56, there is no stress in the slab at the ends, and a maximum compression across the section AA. This increase of stress involves shear in the slab on planes parallel to the rib, and, in accordance with well-known principles of mechanics, this shear may be replaced by diagonal compression stresses and tensile stresses at right angles to them, as shown on the figure and explained more fully on p. 80. These stresses will vary with the distribution of shear along the beam. To obtain the maximum stresses in the slab, these shear stresses have to be combined with the primary compressive stresses.

The rule that b_s shall not exceed a certain proportion— $\frac{1}{3}$ or $\frac{1}{4}$

—of the span is intended as a safeguard against failure by shear in the slab. Such a failure is, however, better guarded against by making calculations of the shear on these planes, and treating the resistance to shear by the principles already discussed. If there is no reinforcement in the slab, such shear must not exceed 60 lbs./ins.², or failure may occur by the tension stresses referred to above. In the calculation of such stresses, it should be considered whether the whole thickness of the slab should be utilized, since the upper two-thirds is generally already overstrained in tension by the negative moment in it. On the other hand, the existence of compression forces on the lower portion of such slabs will frequently add to their resistance.*

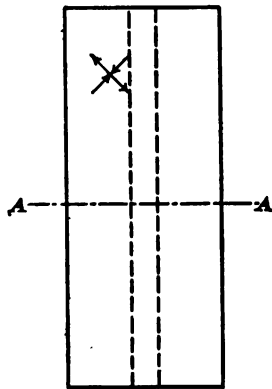

FIG. 56.—Analysis of stresses in slab of T-beam.

When ample slab bars cross the beam, as is generally the case, they prevent failure by tension across diagonal planes very much as stirrups do in the rib of the beam, and the slab may be considered as a lattice girder in which the bars form tension members and the diagonal compression is taken up by the concrete, as shown diagrammatically in Fig. 57. It follows from this that if this shear in the T-slab adds to the stress in the slab bars, it is not desirable to cut the design of these too fine.

In the case of panels having main and secondary beams, the slab reinforcement generally spans between secondaries, and then there is frequently no difficulty in obtaining adequate resistance to shear in the slab even when b_s is comparatively large compared to l .

In the case of the main beam, the slab reinforcement across them is generally much smaller, and the question then requires careful consideration.

In the case of continuous beams, a few important points

* This only applies, however, when the slab is designed to have the necessary resistance to reverse moment at the beams.

must be noted. The section at which no bending moment occurs—the point of contraflexure—is now some distance along the beam instead of being at the end, and the obliquity of the inclined compression forces in the slab will be proportionately greater. Thus, supposing that a beam with a central concentrated load has equal moments at the centre and at the supports, the point of contraflexure is at the quarter points, and the inclined compressions should be considered so disposed that the whole of the central compression has been taken up at

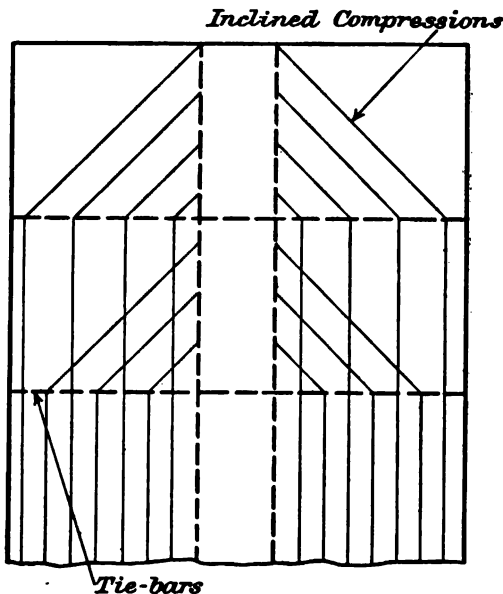

FIG. 57.—Analogy with lattice girder.

this point. It will be found that identical values of the stresses due to *shear* in the slab are obtained if the central compression is calculated from the *total* bending moment, neglecting continuity, and the point of contraflexure is taken as the end of the beam. Thus, for the beam with a concentrated load referred to, it makes no difference, as regards the stresses due to shear, whether the central compression is calculated from a moment of $\frac{Wl}{8}$ and the point of contraflexure is taken as the quarter point, or

whether the central compression is calculated from a moment of $\frac{Wl}{4}$ —the *total* moment—and the point of contraflexure is taken at the end. The latter is frequently the simpler way to treat such stresses.

It will be found that this has an important bearing on the safe value of $\frac{b_s}{l}$ which the R. I. B. A. report would limit to one-third. The considerations just explained show that even if the effect of slab bars as stirrups be neglected, l in the equation

$$\frac{b_s}{l} = \frac{1}{3}$$

should be taken as twice the length from midspan to the point of contraflexure, not the span of the beam. The authors do not, however, approve of limiting this ratio to any fixed value, but would treat each case on its merits. It is unfair to capable designers, and a detriment to the industry, to make regulations involving waste of material solely because such regulations are simple, which appears to be the only justification for the one in question.

PART II

THE DESIGN OF COLUMNS

CHAPTER V

THE STRENGTH OF COLUMNS

To judge from the regulations issued by various learned bodies and authorities, one is tempted to think that the design of a reinforced concrete column is one of the simplest problems that a designer can have.

Perhaps it is in the nature of things, that when a problem becomes very intricate it is simplified ruthlessly by neglecting important considerations, and certainly a careful designer who attempts to study the problem closely will find that the design of columns is very far from being simple, and that in current literature on the subject, and in the practice of many designers, very vital factors are neglected, which, in the opinion of the authors, are responsible for some of the mishaps with this beautiful and long-suffering material.

The difficulty lies chiefly in determining exactly the eccentricity of the load in the column. In the calculations of reinforced concrete columns this is generally assumed to be zero—*i.e.* the load is assumed central—even under conditions in which there is obviously some bending in the column in addition to the direct load, while good practice in steel design has for some time past involved allowances for such bending.

When it is remembered how small an eccentricity will suffice to double the stress in a member,* some idea may be obtained of the magnitude and danger of the error involved.

* The eccentricity necessary to double the stress on a reinforced concrete column is approximately one-sixth of the diameter.

Consider, for example, such a structure as is shown in Fig. 58. It is obvious that the application of a load on the beam will cause it to deflect, and that the ends of the beam will have a certain slope impressed on them. Since the joint of the beams and columns is rigid, it follows that the column must be bent too.

The structure after deflection assumes the form in Fig. 58(a), which is of course somewhat exaggerated.

It is obvious that the column is subjected to a bending moment in addition to its direct load, and as a matter of fact the maximum stress in such a column may easily be 200 per cent. in excess of that due to the direct load alone. The importance of the determination of the eccentricity will therefore be easily appreciated, and unfortunately the problem is as difficult as it is important.

In the case of steelwork a similar problem exists in the determination of the eccentricity of the loads on outside columns, but the problem in that case is frequently much simpler,* owing to the fact that the rigidity of the joint

* This is not invariably so, and with some forms of connection this method of calculation is not justifiable.

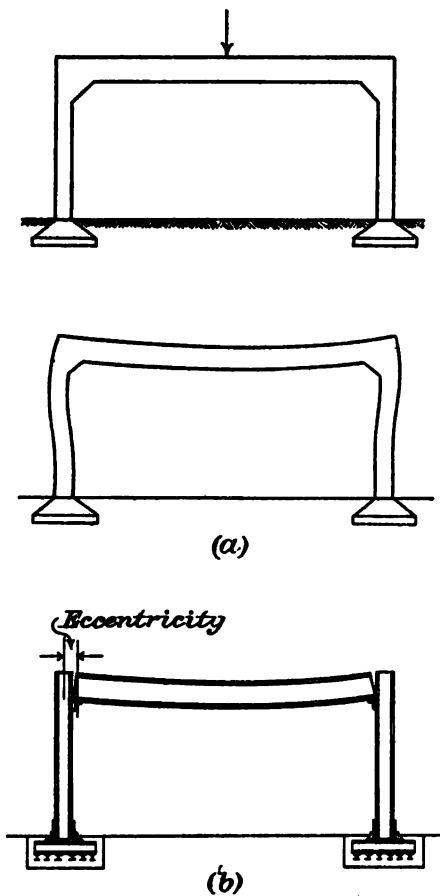

FIG. 58.

between the beam and the stanchion is small in comparison with that of the beam or of the stanchion itself. Consequently the beam can generally deflect sufficiently to take its load without causing the stanchion to bend with it, the joint being sufficiently flexible to make this possible. The eccentricity can therefore be taken as the distance from the centre line of the stanchion to the centre of the cleat on which the beam rests, or some similar dimension, depending on what form of joint is adopted. The conditions are then as shown in Fig. 58 (b). Compared to our problem in reinforced concrete, this is delightfully simple.

With reinforced concrete, instead of the joint being flexible compared to the beam or the column, it is generally at least as stiff as either, and no such easy solution is possible. It is obvious, however, that the eccentricity must in general be greater than for steelwork, since the column is constrained to bend through a greater angle.*

The authors think that most designers will readily acknowledge the importance of considering these secondary stresses. A school of designers does, however, still exist which professes to believe that if the beam is designed without making an allowance for the fixing due to the columns, no moment need be allowed for in the design of the latter, and that the fixity which the columns will actually provide can only afford additional security.

The reply to this is, of course, that while the fixity may not weaken the beam, it can, and does, weaken the column. It should, in fact, be recognized to a greater extent that designing a member on a certain assumption does not make that assumption hold. Exactly similar arguments are frequently made for neglecting certain moments at the base of circular reservoirs, and in many other cases, some of which will be dealt with in their place.

With this introduction we may proceed to consider the design of columns in detail. It will be convenient to divide this into two portions, dealing respectively with the resistance

* The only exception to this is where the beam is very stiff or short compared to the columns, in which case the slope of the beam at its end may be less than the slope of the column induced by a load having the eccentricity assumed for steelwork.

of columns to direct and eccentric loads, which will be treated here, and with the determination of such loads and eccentricities as treated in the two following chapters.

(a) SHORT COLUMNS

Concentric loading.—It was shown on page 44 that, on certain theoretical assumptions, the longitudinal steel in a column may be assumed to be replaced by $(m - 1)$ times its area of concrete, which gives, for the safe load on a column,

$$P = c\{A + A_L(m - 1)\}.$$

Before such an expression can be used in design, it is necessary to review several considerations greatly affecting the strength of a column.

If a column be reinforced with longitudinal bars only, as in Fig. 59, it is found that when reinforced it has not nearly the excess of strength over that of a plain column which is indicated by the above formula. In several tests, the reinforced column has actually been found to be weaker than the plain column. It follows from this, that if the formula is to be used at all, it must be with considerable restrictions.

A column reinforced as in Fig. 59 fails by buckling of the reinforcing bars, which will in any practical example have a very great ratio of length to diameter, and will therefore only carry a very small load before buckling takes place. It is obvious that when no ties are provided, this buckling is resisted by the tensile strength of the concrete alone, and accounts for the low strength of columns reinforced longitudinally only. The premature buckling of the bars may be prevented by the use of ties at intervals, and, considered from this point of view, the distance apart of the bindings should theoretically be some function of the size of the bar, such as 16 times its diameter, and the formula should be strictly applicable to columns, when this spacing of the ties is not exceeded. Experiments show, however, that this is not so, and also that the ties have other functions beyond that of preventing the buckling of the



FIG. 59.

longitudinal reinforcement. When the ties are placed at very small intervals, and are of suitable form, they hinder the lateral expansion of the concrete which accompanies its shortening in a longitudinal direction, and by so doing enable it to resist greatly increased stresses before failure occurs.

This phenomenon was first studied by Considère,* who considered the value of this form of reinforcement so great that he patented the application of helices for this purpose. His theoretical calculations, which are confirmed by experiments, show that under favourable circumstances the increase of ultimate strength obtained by the use of helical binding may be 2.4 times that obtained by the weight of reinforcing steel disposed in a longitudinal direction.

A formula has therefore been proposed for the calculation of the safe load on helically, or, as it is sometimes termed, spirally, reinforced columns, of the form

$$P = c \{A + (A_L + 2.4A_H)(m - 1)\}$$

where A_H is the volume of steel in the helix divided by the length of the column, that is, the area of the same weight of steel longitudinally disposed.

For this formula to be used at all the following provisos must be observed:—

1. The area of the concrete A must be taken as that inside the helix only, that outside being neglected in calculating the strength of the column. The necessity for this is obvious, since it is found by experiment that such covering spalls off long before the ultimate stress is reached, owing to the great shortening which accompanies the high stresses developed.

2. The pitch of the helix must be small. It should not exceed one-seventh of the diameter of the helix when a small percentage of reinforcement is used, and should be still smaller as the percentage is increased. The reason for this is that the greater the percentage of helical reinforcement, the greater the stress in the concrete, and the greater, therefore, the tendency for it to swell laterally between two adjacent turns of the helix.

3. Considerable longitudinal steel must be provided in

* *Le Génie Civil*, 1902.

addition to the helix. To develop the best results, this should be proportioned to the size and pitch of the helix. Generally at least eight rods are required. Their function is largely to prevent the lateral bulging of the concrete between the individual turns of the helix, and they should therefore be greater in diameter when the pitch of the helix is large.

It is, of course, not suggested that helical reinforcement does not add to the strength of a column when the foregoing conditions are not observed, but that it does not add to the strength to the extent indicated by the formula, which may under such conditions become dangerous.

Even under conditions when the formula does apply, as regards the calculation of the ultimate loads, it is open to some doubt whether it is desirable to use it for the calculation of safe working loads with the usual factors of safety. This arises from the fact that before these high stresses are reached, and the spiral is stressed to its elastic limit, the concrete has to be deformed to such an extent that it is permanently disintegrated. This may not be important where a steady load has to be supported, but the authors would require considerable experimental evidence before using a concrete in such a condition where heavy shocks or vibration has to be resisted. It is also open to question whether such concrete is able to withstand the action of frost, as well as concrete at the usual stresses.

It must be remembered that the provision of helical reinforcement does not reduce the stress in the concrete below

$$c = \frac{P}{A + A_r(m - 1)},$$

but increases the stress to which the concrete can be subjected before failure takes place. Consequently, if enough helical reinforcement be added to double the strength of the column, and full advantage be taken of this, the working stress in the concrete is increased say from 600 to 1200 lbs./ins.², and although the factor of safety may be satisfactory for a short period, it does not follow that it will not lessen under many repetitions of load and adverse climatic influences; anyhow, when full advantage is taken of the hooping to the extent

indicated by the formula, it is certain that the deformation, and the tendency of the column to buckle, are considerably greater than in a column made and calculated in the ordinary way.

In this connection it is also to be observed that in the case of a severe fire, a column in which the hooping is relied upon for a large part of the supporting power, is more liable to fail than is an ordinary concrete column. In the former, it is well known that the concrete outside the spiral is liable to spall off when high stresses are used, and this liability of course increases greatly in case of fire; when once a portion of this protective covering is damaged and the helix is exposed to the heat, the advantage obtained from the hooping will be almost entirely lost. In the case of any ordinary column, the disintegrating of the outer layer only causes a reduction of strength proportional to the loss of area, which is generally small.

It must be understood that the authors do not wish to say a word against the use or efficiency of helical binding. On the contrary, they are of opinion that it is in many cases a very suitable reinforcement for a column, particularly where it is short in comparison to its length, and where its function is almost entirely to resist direct compression rather than bending moments.

They do, however, consider that Considère's formula, when used for the calculation of safe working loads, gives too great a value to the helical reinforcement, and may in some cases seem to justify structures with a smaller permanent factor of safety than is desirable.

Referring back now to columns reinforced with longitudinal bars and cross ties at intervals, it has been stated that the cross ties serve to prevent the buckling of the bars, but also add to the strength of the column by preventing the lateral expansion of the concrete, in the same way as does helical reinforcement. This is shown by the fact that the ultimate strength of the column is increased by reducing the pitch of the bindings, even when the pitch is much less than is required to prevent the buckling of the bars under elastic stresses.

Consequently an accurate formula for columns should take the quantity of such lateral bindings into account, as well as

the longitudinal steel, and since the efficiency of the ties as hooping diminishes with increase of the pitch, it is necessary to take this into account also.

Tests of columns also show that longitudinal steel is more effective when closely bound than when bound at considerable intervals, and for this reason it is desirable to take the spacing of the ties into account in the determination of m in the formula

$$P = c\{A + (m - 1) A_L\}.$$

A formula was proposed by the French *Commission du Ciment Armé* of 1907 which takes all these factors into account.

$$P = c(A + mA_L)\left(1 + m' \frac{V'}{V}\right)$$

Putting d = least dimension of the column, m^* is to vary between the limits 8 and 15, the lower value being adopted when the diameter of the longitudinal bars exceeds $d/10$ and when the spacing of the ties is equal to d . This may be taken as the maximum spacing of the ties in practice, and when they are spaced so far apart, special care must be taken that they are neither displaced by ramming nor carelessly set out.

The maximum, 15, may be adopted when the diameter of the longitudinal bars does not exceed $d/20$, and when the spacing of the ties is less than $d/3$.

$\frac{V'}{V}$ is the ratio of the volume of steel in the ties to the total volume of the column, and the factor m' expresses the efficiency of this binding, which varies with the spacing.

For ordinary links or ties forming a rectangle in the cross section of the column, m' may vary between limits of 8 and 15, the corresponding spacings of the ties being d and $d/3$ respectively.

For helical binding it may vary from 15 to 32, the lower

* As the French Report acknowledges that m is a factor derived as the result of experiments on columns, and is not necessarily $\frac{E_s}{E_c}$, there is no object in writing $(m - 1)$ in the formula. One could, however, write the formula $P = c\{A + (m - 1)A_L\}\left(1 + m' \frac{V'}{V}\right)$, but the values of m must then be taken as greater by one than those proposed by the French Commission.

value being adopted when the pitch of the helix is $\frac{d}{2.5}$, and the upper value may be adopted when the pitch of the helix does not exceed

$\frac{d}{5}$ for a stress not exceeding 50 kilos./cms.² or 711 lbs./ins.²

$\frac{d}{6.5}$ " " 80 " " 1140 "

$\frac{d}{8}$ " " 100 " " 1422 "

and provided that longitudinal bars, at least six in number, are used, having an area of at least 0.5 per cent. of the area of the helix and a volume of not less than one-third of that of the helical reinforcement.

A very important and admirable proviso in the recommendations in which the formula is given is that under no circumstances may the working stress in the concrete exceed 60 per cent. of the ultimate strength of plain concrete, however much lateral or helical reinforcement be provided.

The values of the stress c recommended for use in the formula is 28 per cent. of the ultimate strength at 90 days. The ultimate strength for various richnesses of concrete should be, according to the Commission, as follows:—

TABLE I.—*Ultimate strength of concrete.*

Concrete.	Gravel.	Sand.	Cement.	Ratio of cement to sand + gravel by volume.*	Ultimate strength at 90 days.	
					K./cms. ²	lbs./ins. ²
(a)	litres. 800	litres. 400	kilos. 800	1:5.8	160	2280
(b)	800	400	350	1:5.0	180	2565
(c)	800	400	400	1:4.35	200	2850

Consequently the safe value of c , the working stress, may, according to the French rules, be taken as

* If the sand and gravel are mixed before proportioning, they will occupy less space, and will therefore require more cement by volume to give the same proportion of cement by weight.

TABLE II.—*French safe working stresses in columns.*

Concrete.	Safe stresses.	
(a)	44·8 kilos./cms.*	640 lbs./ins.*
(b)	50·4 ,,	718 ,,
(c)	56·0 ,,	797 ,,

The proviso that under no circumstances may 60 per cent. of the ultimate strength of plain concrete be exceeded, no matter how much hooping or lateral binding is provided, limits the value of $c \left\{ 1 + m' \frac{V'}{V} \right\}$ as follows:—

TABLE III.

Concrete.	Limiting value of $c \left(1 + m' \frac{V'}{V} \right)$	
(a)	98 kilos./cms.*	1865 lbs./ins.*
(b)	108 ,,	1588 ,,
(c)	120 ,,	1708 ,,

In the authors' opinion, the French rules and formula constitute by far the best method of calculating the strength of columns which has yet been devised.*

They may appear to be more complicated than is desirable, but the problem requiring solution is a complicated one having many variables, and it will be found that any simple formula neglects some of the factors which have a direct bearing on the strength of the column, and which are taken into account in the French Regulations.

As regards the working stresses allowed in France, it must be noticed that the weakest concrete considered—concrete *a*—is richer than that usually employed in this country (1 to 6). It is certainly on the right lines to allow higher loads with richer concretes as is done in France, since this increase of

* If the R.I.B.A. Report (1911) is referred to (p. 317), it will be found that the column rules are largely copied from the French Report of 1907, and the varying values of the terms in the formula are clearly tabulated.

strength is certain and permanent, and there is much to be said for the use of rich mixtures, especially in columns.

One factor of importance exists in this connection, which appears to be neglected even in the French rules for columns, and that is the variation of $\frac{E_s}{E_c} = m$, which obtains when the richness is altered. The magnitude of this variation may be seen from the following table, obtained from tests on 12-inch cubes by Mr. George A. Kimball at the Watertown Arsenal. The moduli are computed, with the permanent set deducted, from the deformation, so that the values are slightly higher than would be obtained from the total deformation. The values given are averages of several tests.

TABLE IV.*

Proportions.	Ordinary wet concrete.		Exceptionally strong concrete.	
	Crushing strength at 30 days, lbs./ins. ²	Modulus of elasticity, lbs./ins. ²	Crushing strength at 30 days, lbs./ins. ²	Modulus of elasticity, lbs./ins. ²
1:1½:3	2300	2,500,000	2800	3,600,000
1:2:4	1700	2,000,000	2500	3,200,000
1:2½:5	1500	1,800,000	2200	2,800,000
1:3:6	1300	1,600,000	1900	2,500,000
1:4:8	900	1,300,000	1500	2,000,000

This table shows very clearly that a rich mixture involves a lower value of m , and that the advantage of the increased strength is partly, though only partly, offset by a reduced efficiency of the longitudinal steel. It would be interesting to have this confirmed by experiments on actual columns.

The table also shows the great difference in the modulus of ordinary wet concrete and "exceptionally strong concrete," which presumably means concrete mixed dry and rammed hard. It is less important to consider this in a formula for practical use, since concrete of the latter kind cannot be used in practice with ordinary arrangements of reinforcement.

* Taken from Taylor and Thompson's *Reinforced Concrete Design*, 2nd edit, p. 405, by courtesy of the authors. The values for a 1:2:5 concrete, which gave a very low strength and modulus, are omitted, as these results would appear to indicate that the percentage of sand was too small to give a dense concrete.

While discussing binding, it is interesting to study briefly a series of tests of columns made by Prof. Bach at Stuttgart.* All the specimens were 1 metre (39·4 ins.) long, and 250 mm. square (9·85 ins.). Some were unreinforced, the remainder having four rods 180 mm. centre to centre, varying in diameter from 15 to 30 mm. They were provided with links of 7 mm. diameter, at centres varying from 6·25 to 25 cms., as detailed in Table V. and Fig. 60.

TABLE V.

Specimen number.	Diameter of longitudinal bars.	Spacing of links.	Percentage of longitudinal bars.	Percentage of links.
	mm.	cms.	—	—
1	—	—	—	—
2	15	25·0	1·14	0·401
3	15	12·5	1·14	0·802
4	15	6·25	1·14	1·604
5	20	25·0	2·04	0·401
6	30	25·0	4·60	0·401

They were made in the proportions of 1 of cement to 4 of sand and gravel, and the ultimate strength of cubes of the same concrete was found to be 176 kg./cms.² = 2510 lbs./ins.² The specimens were about three months old when tested. Calculating the safe working load by the R.I.B.A. rules of 1907,

$$P = 500(A + 14A_L) \text{ in English units,}$$

$$\text{or } P = 35\cdot2(A + 14A_L) \text{ in metric units,}$$

the values given in Table VI. are obtained, a comparison of which with the actual breaking loads gives the effective factor of safety.

TABLE VI.

Specimen.	14A _L	(A + 14A _L)	P (R.I.B.A.)	P A	Ultimate load.	Effective factor of safety.
	cms.*	cms.*	kilos.	kilos./cms. ²	kilos./cms. ²	
1	—	625	21·91	35·2	142	4·0
2	99	724	25,500	40·9	168	4·1
3	99	724	25,500	40·9	177	4·3
4	99	724	25,500	40·9	205	5·0
5	176	801	28,100	45·0	170	3·8
6	895	1020	35,800	57·8	190	3·8

* *Mitteilungen über Forschungsarbeiten*, No. 29, and *Rapports de la Commission du Ciment Armé*, 1907, p. 478.

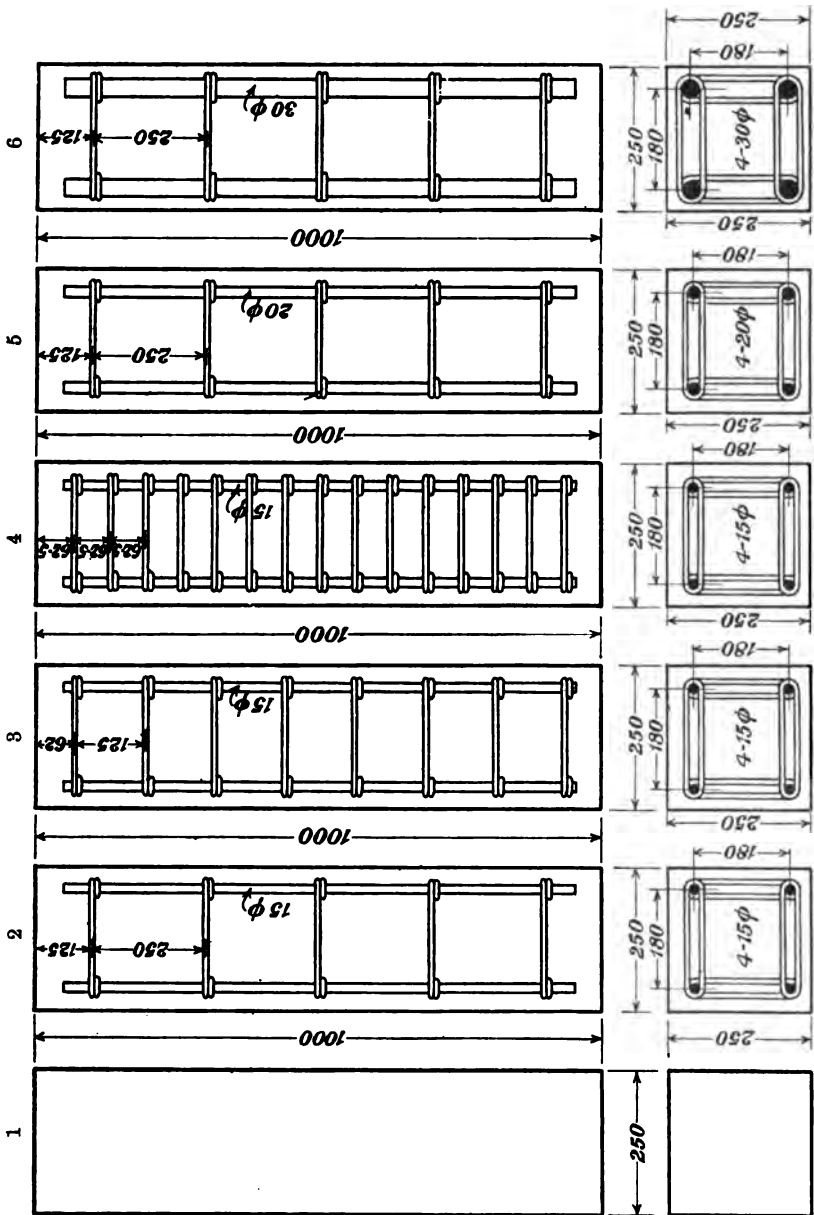

FIG. 60.—Column tests by Bach.

Comparing specimens 2, 5, and 6, in which the spacing of the ties is constant, it will be seen that the factor of safety falls rapidly as the percentage of reinforcement is increased, showing that too great an importance is given in the R.I.B.A. formula of 1907 to the longitudinal bars.*

Comparing, on the other hand, specimens 2, 3, and 4, in which the size of bars is constant, it will be seen that the factor of safety rises rapidly as the spacing of the ties is reduced, this factor being also neglected in the formula.

If we now calculate the safe working loads by the French rule, and compare these with the breaking loads, we get the results of Table VII.: c is taken at 50 kilos./cm.²

It will be seen that the factor of safety is sensibly constant, showing that the formula is of the right form, and that correct values have been given to the factors m and m' .*

Particular attention is drawn to the value of the factor of safety. Although the value of $c = 50$ kilos./cm.² is somewhat less than is permitted by the regulations for the concrete used, it will be seen that though the working stresses allowed are

* These remarks are intended to refer to the analysis of Bach's tests only, and would apply in practice only to just such an extent as the conditions of the specimens in question approximated to those of practice. In the opinion of the authors, these tests, on which the French rules were largely based, were largely vitiated by the following considerations. The load is transmitted from the testing machine direct on to the end of the column, where there is no longitudinal steel, and hence at the ends the concrete alone carries the load. It follows that, although the longitudinal steel may be effective in increasing the strength of the column at some distance from the end, at which its appropriate stress has been gradually transmitted to it from the concrete through its adhesion, the longitudinal steel cannot, in these test pieces, be fully effective near the ends.

In practice, these conditions do not, in good designs, apply. At the lower ends of a column, the bars project a sufficient distance into the footing to be able to take up their full stress at the upper edge of the footing, or they rest direct on a plate in the footing. At the upper end, the load is generally applied gradually at different floor levels, and even then the bars have the depth of the beam in which to take up the load from that beam.

For these reasons it must be admitted that it is only to be anticipated that Bach's tests would not show much advantage in the longitudinal steel, while there is no reason to suppose that such steel is not fully effective in good practice. If column tests are to be made without this defect, it is merely necessary to provide an enlarged cap and baseplate of sufficient area to enable the full load to be carried by the concrete only at the ends, and of sufficient length to enable the appropriate stress to be transmitted to the bars.

This was done in some extremely interesting tests by Mr. Popplewell, described at the Inst. C.E. on Jan. 9, 1912. Tests on columns provided with the necessary enlarged ends are being made under the authors' supervision by Messrs. Trollope and Colls.

TABLE VII.—French column rules applied to Bach's column Tests.

Specimen.	m	m. A _L cms. ²	A + m. A _L cms. ²	Spacing of links, cms.	m'	$\frac{V'}{V}$	$c \left[1 + m' \frac{V'}{V} \right]$ kilos./cms. ²	Calculated safe load. kilos.	Breaking load. kilos.	Effective factor of safety.
1	—	—	—	—	—	0.00401	50	81,250	88,800	2.8
2	10	71	696	25	8	0.00802	51.6	85,918	105,000	2.9
3	12	85	710	12.5	12	0.01604	54.8	88,908	110,500	2.8
4	15	106	731	6.25	15	0.00401	62.0	55,922	128,000	2.8
5	9	118	788	25	8	0.00401	51.6	48,080	106,000	2.8
6	8	226	851	25	8	—	51.6	48,911	118,600	2.7

high, they give a factor of safety equal to that which really obtains in beams, as noted elsewhere.

The remarks as to the advisability of not taking full advantage of the increase of the strength obtained by helical binding applies with equal force to the links in cross binding, with the additional reason that links are very liable to displacement during concreting, more so perhaps than any other members. For this reason, the authors would advocate lower values for the coefficients m' in the calculation of working loads. It may be well to remind the reader here, that these tests are with absolutely central loads. When any flexure is combined with the direct load, as generally occurs in actual structures, the factor of safety is greatly reduced unless such flexure be carefully allowed for.

Eccentric loading.—The moments or eccentricities produced on a column are dealt with in Chap. VII.

Practically no experiments appear to have been made on the resistance of reinforced concrete columns to eccentric loads.* This being so, it is necessary to fall back on theory.

It has been shown in Chap. III. how to design a member for combined bending and compression, and calculations are conveniently made as there explained.

As regards design, symmetrical reinforcement is generally advisable. This is not obvious, especially in cases where the column is subjected to tension on one face. It must be remembered, however, that the bending moment generally changes from a maximum value in one direction immediately below a floor beam to a maximum value in the opposite direction immediately above, and consequently the tension face below the floor-level becomes the compression face above, and *vice versa*.

It follows that where the stress in the bars has to change from a maximum compression to a maximum tension in so short a distance, a heavy bond stress will be produced. This may be reduced by providing adequate haunches between beams and columns, and thus increasing the length in which this change in stress is to be taken up. Such haunches will always

* A few tests were made by M. O. Withey at the University of Wisconsin in 1909. The eccentricities in these tests were, however, very small, and all the columns tested had spiral binding.

be found advisable, especially in the case of outside columns, where the eccentricity of loading is greatest.*

Generally speaking, it is economical to use a high percentage of steel in outside columns, rather than to adopt a very stiff section. The reason for this will be apparent when one comes to calculate the bending moment produced on the column by the beam. It will be found that this moment increases with the stiffness of the column, sometimes almost proportionately to its moment of inertia.

As regards the value of lateral binding in increasing the permissible value of the stress in columns subjected to considerable bending, it is to be noticed that the concrete subjected to the greatest stress is generally outside these links, as in Fig. 61; in such cases it would not appear to be justifiable to increase the stress above the ordinary safe value for concrete, 600 lbs./ins.² for example.

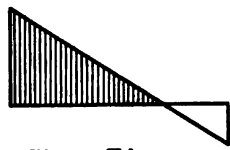

Stress Diagram

FIG. 61.

It is, however, justifiable to neglect the concrete outside the links, and to take d_1 as the effective depth of the column in place of d . Where this is done, some allowance may be made for the increase of resistance due to the links, and, in default of exact knowledge, this increase may be taken the same as for columns concentrically loaded, as already treated.

(b) LONG COLUMNS

Concentric loading.—No experimental data appear to be available on long reinforced concrete columns.

We may, however, adopt Euler's formula—

$$c = \frac{\pi^2 E_c}{S f^2}$$

f is the buckling factor, which has the following values :—

* Haunches are equally advisable for interior columns, but chiefly for a different reason, namely, to provide adequate resistance to the negative moment in the beam.

Case I.—Pin joints at each end, or both ends fixed in direction but not supported laterally.

$$f = l \cdot \sqrt{\frac{A_x}{I_x}} = \frac{l}{r},$$

where r is the least radius of gyration.

Case II.—Both ends fixed in direction and position.

$$f = \frac{l}{2} \sqrt{\frac{A_x}{I_x}} = \frac{1}{2} \cdot \frac{l}{r}.$$

Case III.—One end fixed in position and direction, other end free (that is, not supported laterally).

$$f = 2l \sqrt{\frac{A_x}{I_x}} = 2 \frac{l}{r}.$$

Case IV.—Fixed in position at both ends, one end pin-jointed, other fixed in direction.

$$f = \frac{2}{3} l \sqrt{\frac{A_x}{I_x}} = \frac{2}{3} \cdot \frac{l}{r}.$$

The factor S in the equation is the factor of safety, for which a high value is usually adopted against buckling, since a small eccentricity or deviation from straightness in the column increases considerably the tendency to buckle. Four is not an unusual value for S .

A_x is the area of the equivalent section, that is

$$A_x = A + (m - 1)A_L,$$

r = the radius of gyration of the section,

I_x is the least moment of inertia of the equivalent section.

This is calculated for rectangular sections on page 128.

Where c exceeds 600 lbs./ins.² or whatever stress is allowed for short columns, Euler's formula is not to be adopted.

The R.I.B.A. Report recommends that for columns of more than eighteen diameters in length and fixed in direction at

both ends, the safe stress should be taken as $\frac{c}{1 + K}$, K having

the values given by the following table for various values of

$\frac{l}{d}$ and N , where

l = length of column,
 d = least diameter of column,

$$N = \frac{I_R}{A_R \cdot d^2} = \left(\frac{r}{d}\right)^2.$$

$\frac{l}{d}$	VALUES OF K.		
	$N = 0.098$	$N = 0.075$	$N = 0.0646$
20	0.18	0.17	0.19
25	0.20	0.26	0.30
30	0.29	0.38	0.44

Where the column is fixed in direction at one end only, the safe stress is

$$\frac{c}{1 + 2K}.$$

And if fixed in direction at neither end, the safe stress is

$$\frac{c}{1 + 4K}.$$

In the authors' opinion, neither Euler's nor Gordon's formula, on which the R.I.B.A. Report is based, have adequate justification.

As regards theoretical justification it must be observed that the column is assumed initially straight and concentrically loaded. In practice this does not hold, and an extremely small eccentricity completely alters the safe load when $\frac{l}{d}$ is high.

As regards experimental justification, it should be remembered that there are no tests on buckling of concrete columns, and even the tests on steel columns show very great variations indeed, even when precautions are taken to reduce the eccentricity to extremely small values. Since in practice this eccentricity is certainly often one hundred times that to which it can be reduced in a careful test, these tests give little idea of what is safe in practice. The chief conclusion of the Commission on the Quebec Bridge disaster was that there is at present not sufficient information available for the design of long compression members.

In practical reinforced concrete designing, it is very seldom necessary to use long unbraced columns, and until far greater

experimental information is available, the authors recommend that buckling be neglected in columns having $\frac{l}{d}$ less than 20, and thereafter be limited to the following fractions of the working stress given in Fig. 61 (a).

Eccentric loading.—Long columns eccentrically loaded should be treated as short columns eccentrically loaded, except that the safe stress allowed in the concrete must be the value obtained from considerations of buckling.

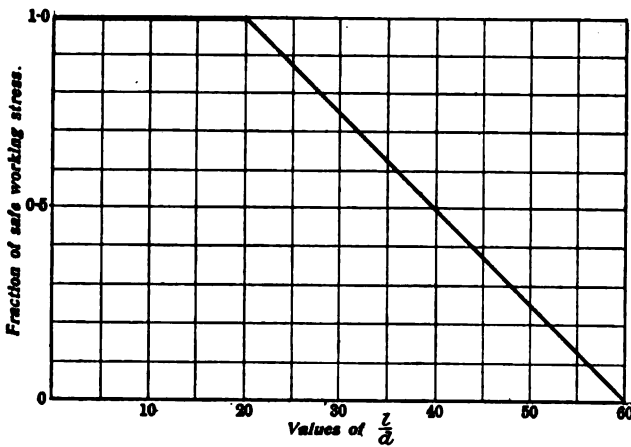

FIG. 61A.—Working stresses for long columns.

It will be seen that the actual design of a long column thus involves a process of trial and correction, since the safe stress cannot be found until the section, and thence $\frac{l}{d}$ has been determined. It is frequently the quickest plan to guess at a section, calculate the stress produced in it by the load and moment, and compare this with the safe stress determined by considerations of buckling. With some experience, a suitable section can in a few minutes be chosen with considerable accuracy.

SPICES IN COLUMNS

Splices in the bars in columns may be made by butting and slipping a piece of gas-pipe over the butt to prevent displacement. Such a joint is good for compression, but has, of course, no tensile strength. Where this is required, it may be obtained by adding a splice bar projecting for a sufficient distance on either side of the joint to obtain the necessary adhesion. The length of column bars covered by the gas-pipe must be neglected in the calculation of this adhesion.

An alternative method is to splice the bars of one tier with those of another. Great care has to be exercised in the design of such a joint, as the concrete is stressed by the transferring of the load from one bar to the other, and this stress is of course in addition to its working stress. Wherever such a splice is made, it is desirable to increase the lateral binding—such as links—beyond what is used elsewhere.

Care is also necessary in the design of the lower portion of the column bars, where they end in a footing. Unless this is unusually deep, it will generally be found that the length of bar projecting into it is insufficient to develop the stress in the bar without exceeding the safe bond stress. In such cases the value of the bar at the lower end of the column in resisting the direct load is less than calculated, and the concrete is therefore proportionately overstressed.

To enable the bar to transmit its stress to the footing, it is a good plan to rest its lower end upon a plate of steel. This plate must not be too near the lower face of the footing, or it may be pushed through bodily before being effective; altogether it is a mistake to cut down unduly the dimensions of footings.

CHAPTER VI

THE DETERMINATION OF THE DIRECT LOADS ON COLUMNS

IN the design of steel framing, practically no restraint is afforded to the ends of the beam. Consequently a beam uniformly loaded will have a reaction at either end equal to one-half the total load. No difficulty is therefore experienced in determining the load on the columns.

When the joints are partially fixed this is no longer true.

Consider the beam in Fig. 62 (a). The reaction is $W/2$ at each end.

If now a reverse moment is introduced at one end, which may be done artificially, as shown in Fig. 62 (b), the reaction R_1 is reduced, and R_2 correspondingly increased.

If the reverse moment (which is, of course, $W_1 \times d$) is increased sufficiently, the beam will be lifted entirely off one support, as shown in Fig. 62 (c); R_2 will equal W_1 and R_1 will be zero. It will be seen from this that the reactions from the beam depend on the reverse moments at the ends as well as the position and magnitude of the loads.

Taking the general case shown in Fig. 63 of a beam with a uniform load w per unit of length, and a reverse moment at the ends of

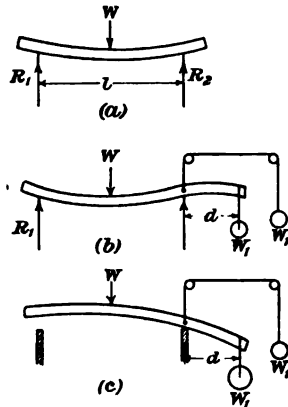

FIG. 62.—Reaction from beam under different conditions.



FIG. 63.—General case of loaded beam.

and a reverse moment at the ends of

M_1 and M_2 respectively, we can easily obtain the relation between the moments and the reactions thus:—

Remembering that the reverse moments at the supports are negative, and taking moments about R_2 , we have

$$R_1 \times l - M_2 = -M_1 + \frac{wl^2}{2},$$

whence
$$R_1 = \frac{wl}{2} - \frac{M_1 - M_2}{l} \dots (1)$$

Similarly
$$R_2 = \frac{wl}{2} - \frac{M_2 - M_1}{l} \dots (1a)$$

These reactions are, of course, those due to the loads on this span only.

Case I. Two spans.—Consider now the arrangement of framing shown in Fig. 64 (a), which has frequently been adopted

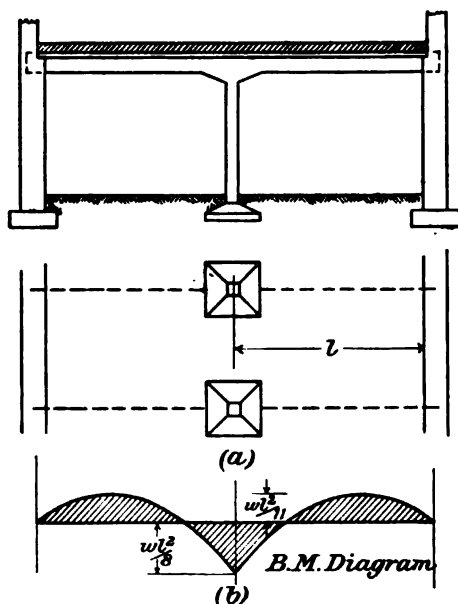

FIG. 64.—Continuous beams, freely supported at ends.

in factories, the beams being continuous over a central row of columns, and frequently supported at the ends in brick walls.

Under a uniform load, and assuming constant moment of inertia of the beam, the bending moment diagram is as shown in Fig. 64 (b).

Considering the left half of the beam, and substituting in equation (1)—

$$M_1 = 0$$

and

$$M_2 = -\frac{wl^2}{8},$$

we have

$$R_1 = \frac{wl}{2} - \frac{wl}{8} = \frac{3wl}{8}.$$

Similarly

$$R_2 = \frac{5wl}{8},$$

and the total load on the column = $\frac{5}{4}wl$.

This is 25 per cent. in excess of that obtained without taking the moments of the beam into account, and of course such an error cannot be neglected with impunity. This value is obtained by considering the load uniformly distributed over *both* spans. In this case it is obvious from symmetry that after deflection the beam will still be horizontal at the column, and consequently this load will have no eccentricity.

The case has also to be considered in which the beam is fully loaded from one wall to the column, and unloaded from the column to the other wall except for the dead load. In this case the load on the column is less than the value given, but it is eccentric, since the deflection on the fully loaded bay will exceed that on the other. This will be treated later (p. 123).

Case II. Three spans.—Analyzing next the arrangement of beams and columns shown in Fig. 65 (a), the bending moment diagram for equal moment of inertia throughout is as shown in Fig. 65 (b), with all bays fully loaded. This curve is slightly modified when the columns are stiff.

Since

$$M_1 = 0$$

$$M_2 = -\frac{wl^2}{10},$$

we have

$$R_1 = \frac{wl}{2} - \frac{wl}{10} = 0.4wl$$

$$R_2 = 0.6wl.$$

From symmetry, the reaction of the centre beam on the column is $\frac{wl}{2}$.

Hence total load on the column = $1.1wl$.

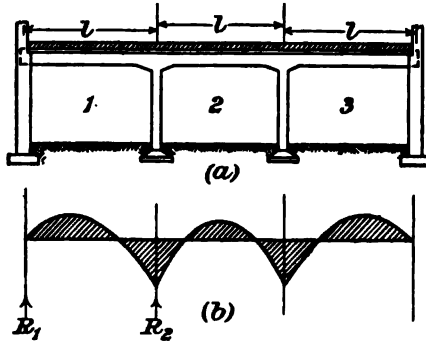

FIG. 65 (a) and (b).—Three spans equally loaded.

This is 10 per cent. in excess of that obtained without taking the moments of the beam into account.

In this case the loads on the columns are not truly concentric, even with all bays equally loaded, as the deflection on the end bays exceeds that on the centre bay, and the deflected structure is somewhat as in Fig. 65 (c).

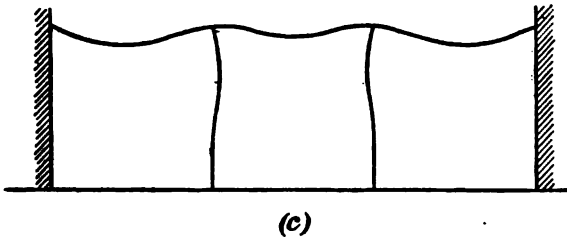

FIG. 65 (c).—Deformation of beams and columns under load.

The value of the eccentricity depends on the relative lengths and stiffnesses of the beams and columns, and will be treated later (p. 123). It should be noted, however, that the value given of the load on the column ($= 1.1wl$) for all bays loaded is not the greatest load which can come upon the columns.

Consider, for example, the case when bays 1 and 2 are fully loaded, and bay 3 is unloaded (Fig. 65 (d)). The bending

moment diagram is then as shown in Fig. 65 (e), the maximum reverse moment over the left-hand column being $0.117wl^2$, while that on the right-hand column is $0.033wl^2$.

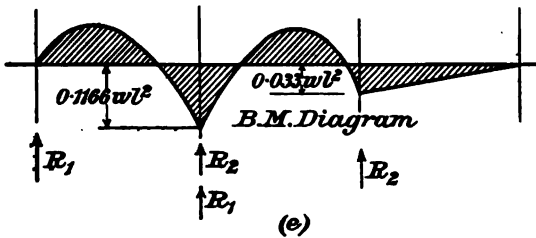
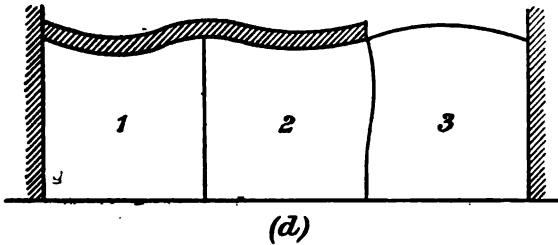

FIG. 65 (d) and (e).—Three spans, one bay unloaded.

Considering the left-hand span, we have—

$$\begin{aligned} M_1 &= 0 \\ M_2 &= -0.117wl^2, \\ \therefore R_2 &= \frac{wl}{2} + 0.117wl = 0.617wl. \end{aligned}$$

Considering the centre span—

$$\begin{aligned} M_1 &= 0.117wl^2 \\ M_2 &= 0.033wl^2, \\ \therefore R_1 &= \frac{wl}{2} + 0.083wl = 0.583wl. \end{aligned}$$

Hence the load on the column = $1.2wl$, or 20 per cent. in excess of that obtained when the moments in the beams are not taken into account.

The values for the moments in the beam stated above do

not take any account of the stiffness of the columns. This is in accordance with the almost universal practice, the columns being considered merely as props.

Under general conditions, it is not usual to get two bays fully loaded, and the third absolutely unloaded, as in Fig. 65 (*d*), since on this last bay the dead load of the structure will at least be present.

The possible load on the column will therefore vary in practice from $1.1wl$ to $1.2wl$, depending on the ratio of the dead load to the total load.

Case III. Four or more spans.—It is not necessary to make a special study of the loads on the columns for many further arrangements, since it will be found that the worst case differs very little, and the maximum load on the column nearest the wall may be taken as varying from $1.1wl$ to $1.2wl$, for ratios of $\frac{\text{dead load}}{\text{total load}} = 1$ and 0 respectively, as in Case II.

For the interior columns, with four or more spans, the case is not so bad.

Considering four spans, the worst case for the middle column

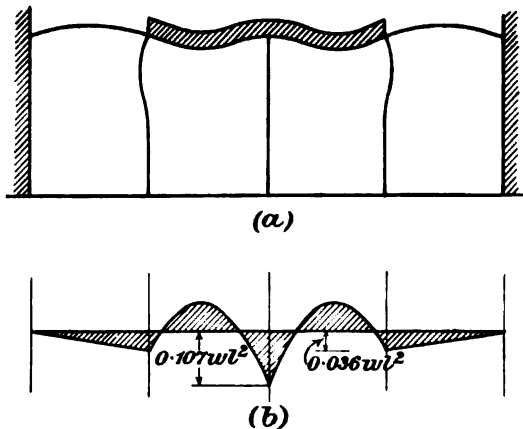

FIG. 66.—Four spans.

is as shown in Fig. 66 (*a*), that is, with the two middle bays fully loaded and the two outer ones unloaded.

With the usual assumptions already mentioned, the

moments are as shown in Fig. 66 (b). From this we get, by the method already explained and illustrated—

$$\text{Maximum load on central column} = 1.14wl.$$

From symmetry this load is concentric with the column.

This may be taken as the greatest load on an interior column for four or more spans, with outside walls non-continuous with the beams, and where the stiffness of columns has little effect in altering the distribution of bending moment in the beams. As before, this result only applies when it is possible to have a bay with no load, *i.e.* when the dead load is negligible compared to the total. In practice, therefore, the possible load will vary between

$$1.14wl \text{ for } \frac{\text{dead load}}{\text{total load}} = 0,$$

$$\text{and } 1.0wl \text{ for } \frac{\text{dead load}}{\text{total load}} = 1.*$$

A slightly worse case can, as a matter of fact, be produced

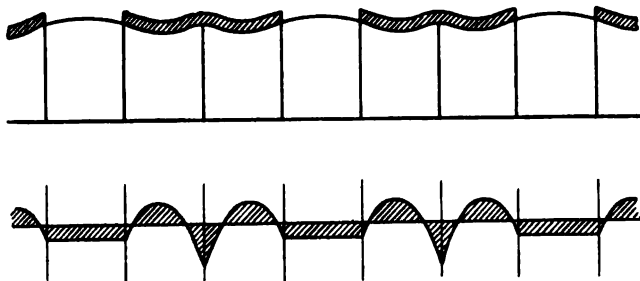

FIG. 67.—Two loaded spans alternating with one unloaded.

with many spans, being that shown in Fig. 67, where two loaded bays alternate with one unloaded bay.

It is shown in Appendix I. 11 that with many spans such a

* This latter value ($1.0wl$) is not absolutely accurate, varying very slightly for the different columns and numbers of columns, but it is quite near enough for practical designing, and may be taken as the load on a column other than those next the wall with four or more spans and all bays equally loaded.

loading gives a maximum reaction of $R = \frac{l}{6} (7 w_t - w_d)$, w_t and w_d being the total and dead load respectively.

Values obtained from this formula may slightly exceed those given above, but the arrangement is so unlikely to occur, and the excess over that given is so small, that the case may be ignored.

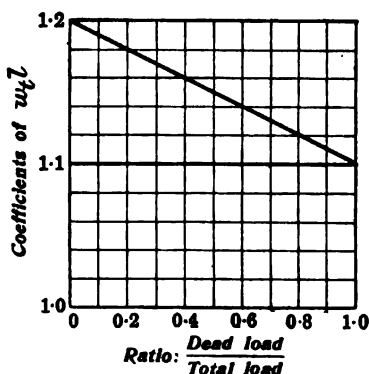

Fig. 68.—Three or more spans, maximum load on column nearest wall.

The above results are summarized and values given for different values of $\frac{\text{dead load}}{\text{total load}}$ in the following table (see also Fig 68):—

MAXIMUM LOADS ON COLUMNS.

No. of spans.	$\frac{\text{dead load}}{\text{total load}}$	Column nearest wall.	Interior columns.
Two	All values	1.25 $w_t l$ *	—
Three or more	0	1.2 $w_t l$	1.14 $w_t l$
" "	0.25	1.175 $w_t l$	1.10 $w_t l$
" "	0.5	1.15 $w_t l$	1.05 $w_t l$
" "	1	1.1 $w_t l$	1.0 $w_t l$

* w_t = total load = live + dead load.

CHAPTER VII

THE DETERMINATION OF ECCENTRICITIES ON COLUMNS

I. INTERIOR COLUMNS

EXCEPT in the lower stories of a building with several floors, the stiffness of the interior columns does not greatly affect the slope which the beams take up under various conditions of loading, the error involved in neglecting it being on the safe side. Since, in addition, the treatment is greatly simplified by neglecting it, this will, in the first instance, be done.

In what follows, the word *slope* is frequently used, and it is perhaps desirable to define what is meant, to prevent any possible misunderstanding.

A freely supported beam will deflect when loaded, and consequently the ends will take up a certain *slope* with their original position, and it is this *slope*, the tangent of the angle turned through, which is referred to below.

It may be pointed out with advantage that a column loaded eccentrically decreases in length more on one side than on the other, and therefore the centre line near the top, although at first vertical, will now take up a certain slope with its original position.

Case I. Two spans (see Fig. 64 (*a*)).—From symmetry the load on the column with both spans fully loaded is concentric.

Consider, now, the case of one span loaded and the second unloaded (Fig. 69), or, more generally, when the left-hand bay has a uniform load of w_l and the right-hand bay a load of w_d per unit of length, where w_l is the total load per unit length, and w_d is the dead load per unit length.

It is quite simple, when the stiffness of the columns is

neglected, to solve this problem completely. This has been done in Appendix I. 6.

The particular quantities which are of interest to us immediately are the load on the column and the slope of the beam at the column, this slope being, of course, impressed upon the upper end of the column.

From Appendix I. 6 we have—

$$\text{The load on the column } R_2 = \frac{5}{8}w_1l + \frac{3}{8}w_2l \quad . \quad . \quad (1a)$$

$$\left. \begin{array}{l} \text{The slope } \alpha \text{ of the beam at the} \\ \text{column} \end{array} \right\} = \frac{1}{EI} \left(\frac{w_1l^3}{48} - \frac{w_2l^3}{48} \right) \quad . \quad (1b)$$

$$\left. \begin{array}{l} \text{And the moment in the beam} \\ \text{at the support M} \end{array} \right\} = - \frac{(w_1 + w_2)l^2}{16} \quad . \quad (1c)$$

The curvature induced on the column will depend upon its length and upon whether it is fixed in direction at its lower end or not. In the case of a column resting upon a footing of considerable size, monolithic with it, the column may generally be considered as fixed in direction at its lower end.

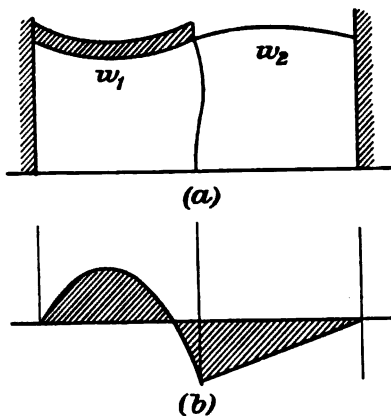

FIG. 69 (a) and (b).—Two spans, one loaded.

It is shown in Appendix I. 1 that if one end of a column is constrained to take up a certain slope, the bending moment required to produce this slope is given in the equation

$$M = -KCE\alpha \quad . \quad . \quad . \quad (2)$$

where $C = \frac{\text{moment of inertia of column}}{\text{length of column}}$,

$E =$ coefficient of elasticity,

$\alpha =$ the slope with its original position taken up by the beam,

$K =$ a constant, depending on the condition of the other end of the column.

Lower End of Column.	Configuration.	B.M. Diagram.	B.M. at Top of Column.	B.M. at Bottom of Column.
Free.	 <p>(a)</p>		$-3 EC\alpha$	Zero
Fixed.	 <p>(b)</p>		$-4 EC\alpha$	$+2 EC\alpha$
Constrained to take up a slope = $+\alpha$	 <p>(c)</p>		$-6 EC\alpha$	$+6 EC\alpha$
Constrained to take up a slope = $-\alpha$	 <p>(d)</p>		$-2 EC\alpha$	$-2 EC\alpha$

FIG. 70.—Bending moment in columns under various conditions of unequal loading of beams supported by them.

K has the value 3 when the other end of the column is free as regards direction, and 4 when the other end is fixed in direction. If the other end has a slope of the same magnitude and direction, $K = 6$, and if it has a slope of equal magnitude but opposite direction, $K = 2$. These results are illustrated in Fig. 70, which gives the bending moment curves on the column under various conditions. These are general results, applicable to any number of spans and any conditions of loading.

From formulæ (1a) to (1c) the loads and slopes induced upon the column may easily be determined for any particular case.

This has been done for four values of $\frac{w_d}{w_t}$, and the results are given in Table I. and plotted in Figs. 71 (a) and (b).

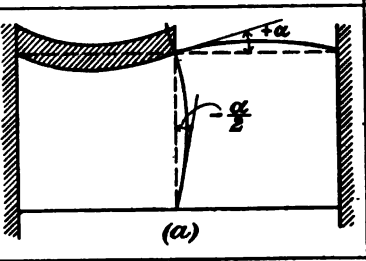
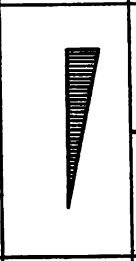
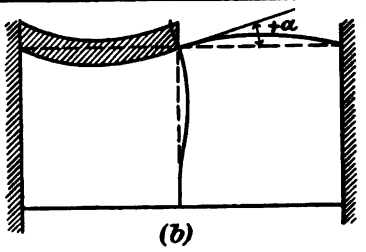
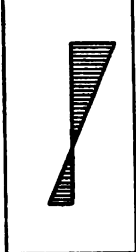
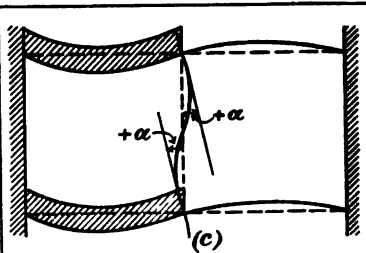
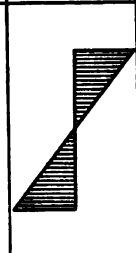
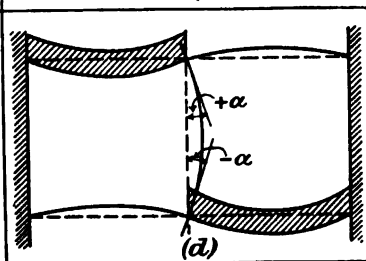
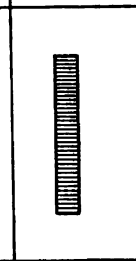
TABLE I.—*Loads and slope induced on a centre column supporting a beam of two spans, free at the ends, with unequal loading on the spans. (Stiffness of column neglected in determining these values.)*

$\frac{w_d}{w_t}$	Load on columns.		Slope of column, α .	
	0	$\frac{5}{8}w_t l$	$0.625w_t l$ *	$\frac{w_t l^2}{48EI}$
0.25	$\frac{25}{92}w_t l$	$0.78125w_t l$	$\frac{w_t l^2}{64EI}$	$0.01562\frac{w_t l^2}{EI}$
0.5	$\frac{15}{16}w_t l$	$0.9375w_t l$	$\frac{w_t l^2}{96EI}$	$0.01042\frac{w_t l^2}{EI}$
1.0	$\frac{10}{8}w_t l$	$1.25w_t l$	0	0

It will be found that the condition of one bay loaded and the other unloaded frequently produces a greater stress on the column than with both bays fully loaded. This is readily shown by an example.

Consider, for instance, the case illustrated in Fig. 72.

- * w_t = the total load per unit length of beam,
- l = the span of beam,
- I = the moment of inertia of beam.

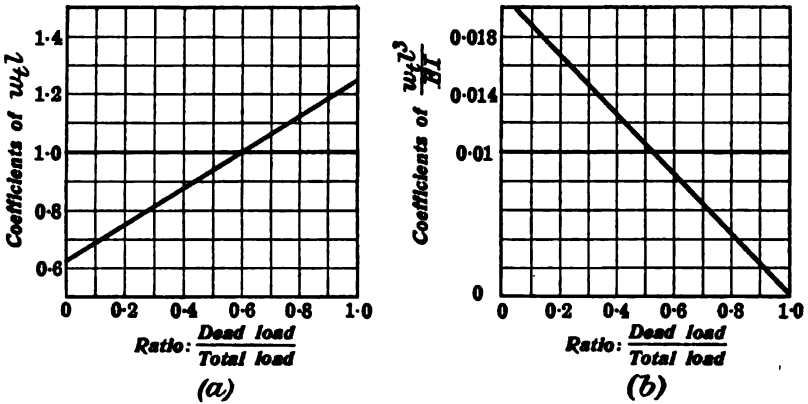

FIG. 71 (a) and (b).—Loads and slopes of centre column supporting a beam of two spans unequally loaded.

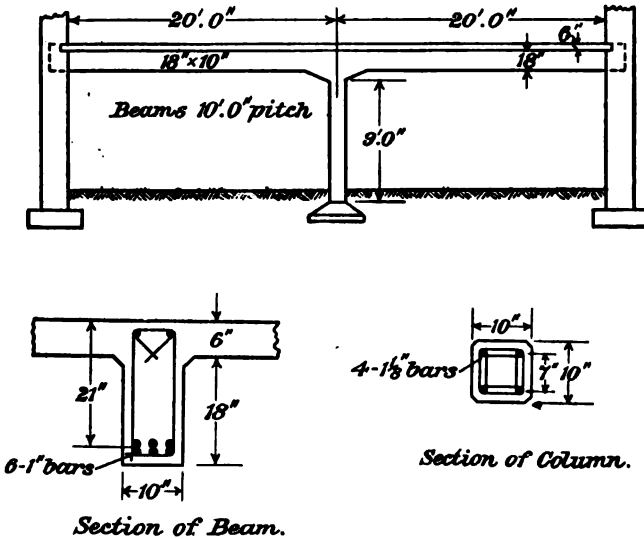

FIG. 72.—Example.

Load per foot run of beam.

$$\begin{aligned} \text{Dead load of slab } 10 \times 75 &= 750 \\ \text{,, ,, beam } \frac{180 \times 150}{144} &= \frac{188}{938} = w_d \\ \text{Live load } 10 \times 200 &= 2000 = w_l \\ &\frac{2938}{w_t} \end{aligned}$$

Maximum load on column (with both bays fully loaded)

$$\begin{aligned} &= 1.25w_t l = 1.25 \times 2938 \times 20 \\ &= 73,500 \text{ lbs.} \end{aligned}$$

With a 10×10 column, reinforced by 4 - $1\frac{1}{8}$ " bars, the equivalent concrete area is

$$\begin{aligned} &100 + 14(4 \times 0.99) \\ &= 155.6 \text{ ins.}^2 \end{aligned}$$

$$\text{Hence stress} = \frac{73,500}{155.6} = 473 \text{ lbs./ins.}^2$$

Consider now the case where one bay is fully loaded, and the other loaded with its dead weight only.

$$\frac{w_d}{w_t} = \frac{\text{dead load}}{\text{total load}} = \frac{938}{2938} = 0.32.$$

Referring to the curve, Fig. 71 (a), we find—

$$\begin{aligned} \text{load on column} &= 0.82 w_t l = 0.82 \times 2938 + 20 \\ &= 48,300 \text{ lbs.*} \end{aligned}$$

And from curve 71 (b),

$$\text{the slope} = 0.0143 \frac{w_t l^3}{EI}$$

Keeping all dimensions in pounds and inches,

$$w_t = \frac{2938}{12} = 245 \text{ lbs. per inch run.}$$

$$l^3 = 240^3 \text{ ins.}^3 = 13,800,000 \text{ ins.}^3$$

$$E_c = 2,000,000 \text{ lbs./ins.}^2$$

To calculate the moment of inertia of the beam, the following method may be used:—

$$\begin{aligned} \text{Width of slab in compression} &= \frac{3}{4} \times 10' \times 12 \\ &= 90 \text{ ins.} \end{aligned}$$

* These results may also be obtained direct from equations (1a) and (1b).

To find the depth of the neutral axis the beam may be considered as a rectangular section 90" wide, with a depth of 21" to the steel and having six 1" bars in tension (4.7 ins.²).

$$\begin{aligned}\text{The percentage of steel} &= \frac{4.7 \times 100}{90 \times 21} \\ &= 0.249.\end{aligned}$$

And therefore the depth of the neutral axis (from the curve of Fig. 10) = 0.24 × 21 = 5 ins.

$$\begin{aligned}\text{The moment of inertia of the steel about the neutral axis.} \\ &= 4.7 \times 16^2 \times 15^* \\ &= 18,100 \text{ ins.}^4\end{aligned}$$

Moment of inertia of concrete about neutral axis

$$= \frac{bd^3}{3} = \frac{90 \times 125}{3} = 3,750 \text{ ins.}^4$$

$$I = \text{total moment of inertia of beam} = 21,850 \text{ ins.}^4 \uparrow$$

* The multiplication by 15 is to reduce it to its equivalent in terms of concrete areas and moments, since the value of E previously given is for concrete.

† When, as is generally the case, the resisting moment of the beam R at certain stresses is known, it will occasionally be easier to calculate the moment of inertia from the equation

$$I = \frac{Ry}{f}$$

where y is the maximum distance from the neutral axis, and f is the stress at that distance.

For the case given above,

$$\begin{aligned}R &= 4.7 \times 16,000 \times 19'' \text{ approximately} \\ &= 1,440,000 \text{ in.-lbs.}\end{aligned}$$

From the percentage of tensile reinforcement, we find

$$n = 5 \text{ ins.,}$$

and the stress in the concrete will be (from the curve of Fig. 11) 350 lbs./ins.²

Hence, considering the concrete, the total moment of inertia will be

$$I = \frac{1,440,000 \times 5}{350} = 20,600 \text{ ins.}^4 \text{ concrete units,}$$

or considering the steel,

$$\begin{aligned}I &= \frac{1,440,000 \times 16}{16,000} = 1440 \text{ ins.}^4 \text{ steel units} \\ &= 15 \times 1440 = 21,600 \text{ ins.}^4 \text{ concrete units.}\end{aligned}$$

The agreement between these results and those given previously is quite near enough for our purpose.

Therefore the slope of the beam over the central column is

$$\begin{aligned} a &= \frac{0.0143w_l^2 l^3}{EI} \\ &= \frac{0.0143 \times 245 \times 13.8 \times 10^6}{2 \times 10^6 \times 21,850} \\ &= 0.0011. \end{aligned}$$

We have seen that if the column is considered as fixed in direction at its lower end, K may be taken as 4, and hence the moment induced in it by this slope will be

$$M = 4CEa.$$

We could, therefore, calculate the bending moment on the column and from it find the stress. We may, however, at once put

$$\begin{aligned} \text{Stress due to bending} &= \frac{My}{I_c} \\ &= \frac{4EI_c a}{l} \times \frac{y}{I_c} \\ &= \frac{4Eay}{l} \dots \dots \dots (3) \end{aligned}$$

It will be seen from this, that when the stiffness of the column is so much less than that of the beam that it may be neglected in calculating the moments and slopes in the beam, it is unnecessary to calculate I for the column.

In our example we have $E = 2 \times 10^6$

$$a = 0.0011$$

$$y = 5 \text{ ins.}$$

$$l = 12 \times 9 = 108 \text{ ins.}$$

Substituting, we have

$$\begin{aligned} \text{stress due to bending} &= \frac{4 \times (2 \times 10^6) \times 0.0011 \times 5}{108} \\ &= 408 \text{ lbs./ins.}^2 \end{aligned}$$

$$\begin{aligned} \text{stress due to direct compression} &= \frac{48,300}{155.6} \\ &= 312 \text{ lbs./ins.}^2 \\ \therefore \text{maximum stress} &= 720 \text{ lbs./ins.}^2 \end{aligned}$$

* Where y is the distance of the extreme fibre of the column from the neutral axis, which is in general the centre line.

It will be seen from this that the stress in the column in this particular example is considerably greater with one bay only loaded than with both bays loaded, although the beams are made short and stiff, and the column relatively flexible.

It is obvious that when the beams are long and shallow, a much greater slope will be produced, and consequently greater eccentricity in the column; this being still further increased if the column is (relatively) short and stiff. The authors have often met with examples in practice where this was so marked that the stress in the column with only one bay loaded amounted to twice that with both bays loaded.

It can be shown that there is a worse case than either of those investigated, when the live load extends fully over one bay and partly over the other, as in Fig. 73.

This has little influence on the moments and slope of the beam, while it increases considerably the direct load on the column.

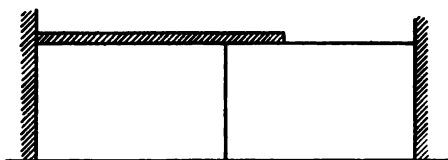

FIG. 73.

When the columns are very stiff compared to the beams, it becomes necessary to take their stiffness into account in calculating the slope of the beams.

It is shown in the Appendix I. 7, that for two spans rigidly connected to a central column, and freely supported on walls at the ends, the slope at the column is given by

$$Ea = \frac{(w_t - w_a)l^2}{8(6B + KC)} \dots \dots (4)$$

where w_t, w_a = the loads per unit of length in the two bays,

l = span of beam,

$$B = \frac{I \text{ of beam}}{l},$$

$$C = \frac{I \text{ of column}}{\text{length of column}}$$

K = the constant in the formula $M = KCEa$, which, as already explained, is 3 when the other end of column is free, and is 4 when it is fixed in direction (see Fig. 70).

Where the column extends both above and below the joint with a beam, as in the lower stories of a building, KC is to be replaced by $K_1C_1 + K_2C_2$, K_1 and C_1 referring to the column above, and K_2 and C_2 to the column below. It is, of course, obvious that the restraining action of the column is increased when the column above has to be bent as well as that below, by unequal loading of the floor.

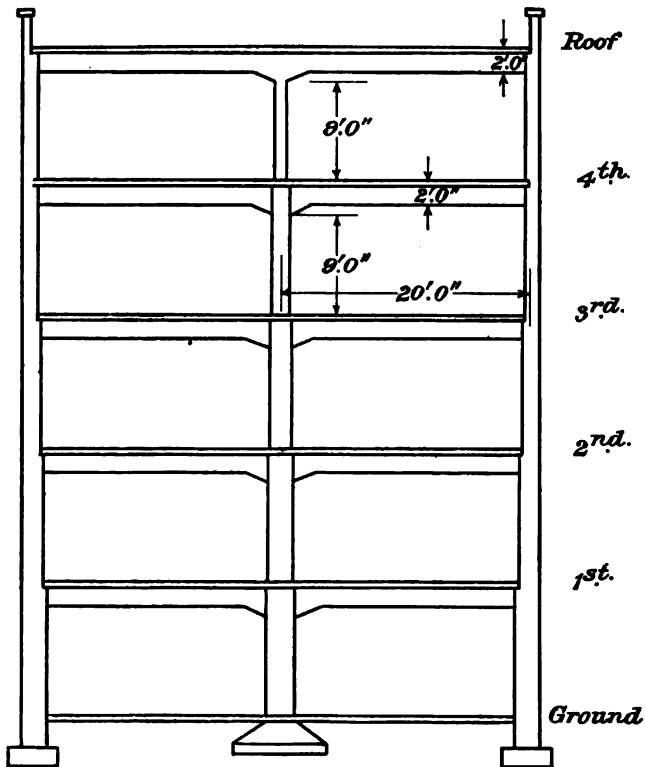

FIG. 74.—Example.

It is thought that it will be instructive to apply this formula to a building having four floors and a roof above ground, all designed for the same load. To save unnecessary labour, the spans, loads, height of columns, etc., will be taken the same as in the last example, and the building to be designed is illustrated in Fig. 74, where this has been done.

Example.—Live load = 200 lbs.

Section of beam 18' × 10", 10 ft. apart.

When these columns are designed for concentric load alone with a unit stress of 500 in the concrete, the lower tiers being designed for the full load due to the weight of the floors above, but the weight of the columns being neglected, the following sizes would be obtained. (The authors do not, however, consider this the correct way of designing columns.)

TABLE II.

Tier.	Maximum concentric load.	Column section.	Steel.	Equivalent area of columns.	Unit stress.
	lbs.	ins. square.		ins. ²	lbs./ins. ²
Roof	(1)	(2)	(3)	(4)	(5)
4th	73,500	10	4-1½"	155·6	473
3rd	147,000	15	8-1"	312·8	472
2nd	220,500	18	8-1½"	461·0	478
1st	294,000	20	8-1½"	597·0	498
Ground	367,500	22	8-1½"	753·0	488

To calculate the stresses in the columns due to bending, using the accurate method represented by equation (4), it is necessary to calculate the I for each of the column sections, which is done in the following table:—

TABLE III.—*Calculation of moment of inertia of columns.*

Tier.	I of concrete = $\frac{bd^3}{12}$	Steel bars along two opposite faces of column.		Distance of steel from C. L. of column.*	Equivalent I of steel.	Total I (10) + (8).
		ins. ⁴	ins. ²			
Roof	(6)	(7)	(8)	(9)	(10)	(11)
4th	833	4-1½"	3·98	3 $\frac{3}{8}$	567	1,400
3rd	4,220	6-1"	4·70	5 $\frac{1}{2}$	2,170	6,390
2nd	8,740	6-1½"	7·81	7 $\frac{1}{2}$	5,220	13,960
1st	13,330	6-1½"	10·56	8	9,460	22,790
Ground	19,530	6-1½"	14·42	8 $\frac{1}{2}$	15,920	35,450

* Taking 1½ ins. cover of concrete.

TABLE IV.—*Calculation of stress due to bending, from equation (4).*

Tier.	$K_1 C_1$ for column above.	$K_2 C_2$ for column below.	$D = K_1 C_1 + K_2 C_2$	$6B\ddagger + KC.$	$Ea = \frac{(w_1 - w_2)l^3}{8(6B + KC)}$	γ	$f = \frac{KEa\gamma}{l}$
	(12)	(13)	(14)	(15)	(16)	(17)	(18)
Roof	—	52	52	598	2001	5	370
4th	52	286	288	884	1440	7½	400
3rd	286	519	755	1801	923	9	308
2nd	519	844	1863	1909	629	10	233
1st	844	1815	2159	2705	444	11	179

TABLE V.—*Calculation of stress due to bending and direct load combined.*

Tier.	Direct load due to floors above.	Load due to unequally loaded floor.†	Maximum direct load with unequal loading on one floor.	Equivalent area of column below floor.	Stress due to direct load. = (21) = (22)	Stress due to bending from (18).	Maximum stress (23) and (24).
	(19)	(20)	(21)	(22)	(23)	(24)	(25)
Roof	—	48,500	48,500	155.6	312	370	682
4th	78,500	„	122,000	312.8	390	400	790
3rd	147,000	„	195,500	461.0	424	308	732
2nd	220,500	„	269,000	597.0	451	233	684
1st	294,000	„	342,500	753.0	454	179	633

In Table IV., the value of $K_1 C_1 + K_2 C_2$ appropriate to the particular joint is calculated, column (16) giving the value of the slope at the joint from equation (4). The stress in the column due to bending is then obtained in column (18), from the equation

$$\text{stress} = f = \frac{KEa\gamma}{l}$$

* K_1 and K_2 taken as 4 (fixed end).

† $6B = \frac{6I}{l}$ for beam = $\frac{6 \times 21,850}{240} = 546$.

‡ Calculated from equation (5), $R = \frac{5}{8}l(w_1 + w_2)$
 $= \frac{5 \cdot 20 \cdot (2988 + 938)}{8}$
 $= 48,500 \text{ lbs.}$

where E_a has been determined in column (16), and y is the distance of the extreme fibre from the neutral axis. As this is greater for the column under the joint than for the column above the joint, it is only necessary to calculate the former, which always gives the greater stress.

The value of K appropriate to any particular structure has to be carefully considered.

Referring back to Fig. 70 (c), it will be remembered that it will have a value of 6 if two adjacent floors are unequally loaded, as shown on that diagram. If this condition is anticipated, then K should be taken as 6. It should be noted, however, that, if we are considering the joint of the column to the upper beam in diagram (c), this value of K only applies to the column *below* that beam. The appropriate value of K for the column *above* the beam depends on the condition of loading of the floor above that under consideration. If that floor is similarly unequally loaded, then the value of $K = 6$ would apply to the column *above* the beam also.

It would, however, be rare indeed for most buildings to have three adjacent floors unequally loaded to the fullest extent (which this requires), and the architect or engineer must use his judgment as to whether he wishes to provide for such loading in any particular building.

In this particular example, it will be assumed that it has been decided that such loads need not be provided for, and that the worst case that need be considered is for the floor above and below to be *horizontal* at the joint. This condition gives us $K = 4$, which is the value that has been used in the example.

The stress due to bending has now to be combined with that due to the direct load, and since the bending only exists when half the floor is loaded with its dead load alone, it is obvious that the direct load will be less than when all floors are fully loaded. The worst case which need be considered is when the floor containing the joint in question is loaded on one side only, and all floors above it are fully loaded. This direct load on the column due to the unequally loaded floor is given in column 20, Table V., by

$$R = 5/8l(w_i + w_a). \quad . \quad . \quad . \quad . \quad . \quad (5)$$

which is obtained from Appendix I. 7. It is interesting to notice that this is quite independent of the stiffness of the column and of the restraint on the beam caused by it.

The load due to the fully loaded floors above is, of course, easily calculated, and appears in column (19).

From these the maximum stress due to direct load is obtained in column 23, and combining this with that due to bending, the maximum stress in the column with unequal loading is obtained in column 25.

A study of column 25, Table V., shows that the stresses developed in the column with unequal loading are very considerably greater than for conditions of full load.

In this particular example the maximum stress occurs immediately below the fourth floor, and is there

$$\frac{790}{47\frac{1}{2}} = 1.67.$$

or 67 per cent. in excess of the stresses obtained in the ordinary way by considering only the conditions of all bays fully loaded.

The authors think that a factor of such magnitude should not be neglected in good design, and feel sure that few engineers would knowingly allow their factor of safety to be reduced to this extent, though they may have done so unwittingly.

Case II. Three spans.—Ends supposed free, *i.e.* resting on walls, for example.

The analysis of the stresses in the two interior columns supporting a continuous beam of three spans involves a similar treatment to that followed in the previous case.

It is, however, slightly more complex, since, on the one hand, a larger number of loadings have to be considered, and on the other, the end beams will generally have either a shorter span or a greater moment of inertia than the middle beam. Since, however, this case frequently occurs in practice, the authors have derived expressions for the slope of the beam at the column taking this into account, and so reduced the analyses of any particular case to a mere matter of arithmetic, which need not even be very laborious.

In what follows it will be assumed that the reader has followed the treatment of the previous case, so that the explanations need not be so full.

(A) Cases when the stiffness of the column may be neglected, in the calculation of the slope of the beam.

A general expression is given in Appendix I. 8, from which the slope of the beam α_2 at the second column may be calculated for any case, even when the spans, loads, moments of inertia, etc., are all different. This expression is very complex, but from it simple expressions may be obtained for simple and less

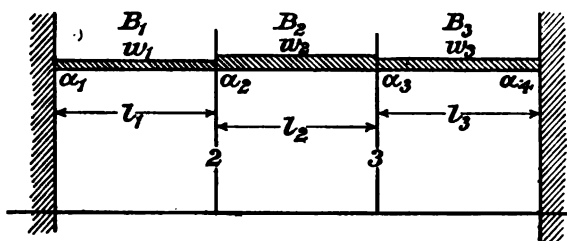

FIG. 75.

general cases, and some such simple expressions will be given here.

As before, let

w = load per unit of length,

l = length of span,

$B = \frac{I \text{ of beam}}{\text{length of beam}}$, the suffixes 1, 2, 3 denoting which

span is in question, and $C = \frac{I \text{ of column}}{\text{length of column}}$

K = a constant depending on the fixity of the column at the other end,

α = the slope of the beam at the column, the suffixes 2 and 3 denoting which column is in question.

If we confine ourselves—as we will do—to cases in which the loading is constant throughout a span, and has for its value either the dead load alone, or dead load + full live load, it will be obvious that any of the following conditions of loading may exist:—

- (a) All bays loaded,
- (b) Two adjacent bays loaded,
- (c) Two end bays loaded,
- (d) Middle bay loaded,

and it is necessary to consider which of these produces the greater stresses on the columns.

It may be shown, however, that it is not generally necessary to analyze all four cases, but that if we take the cases giving

- (i) the maximum load,
- (ii) the maximum slope of beam at its junction to the column,

all other cases will give lesser stresses. Hence case (a), all bays fully loaded, will not be given, though it may be referred to in Appendix I. 8.

Case (b). Bays 1 and 2 loaded.—The condition of maximum load is obviously obtained, as regards column 2, by fully loading bays 1 and 2, and the value of the load is

$$R_2 = 1.2w_t l - 0.1 w_d l^* \dots \dots \dots (6)$$

where w_t = total load per unit of length,

w_d = dead load per unit of length.

The slope of joint of the beam to column 2 is given by—

$$a = \frac{w_t + 2w_d}{30B} \cdot \frac{l^2}{12E} \dots \dots \dots (7)$$

(See Appendix I. 8.)

The slope being given, the stress due to bending may be calculated and combined with the stress due to direct compression, as was done for two spans (see p. 133).

As has already been stated, the two end beams will generally be made stronger than the middle beam, and will therefore have a greater moment of inertia.

The authors have investigated the case in which

$$\frac{B_2}{B_1} = 0.8$$

that is, when the moment of inertia of the middle beam is only 0.8 that of the end beams, which ratio is common in practice. This leads to an expression for the slope

$$a = \frac{w_t + 1.6w_d}{29.9B_2} \cdot \frac{l^2}{12E} \dots \dots \dots (8)$$

* This follows from the results given on pages 118 and 119.

which differs appreciably from that in equation (7) when the dead load w_d is considerable in comparison with the total load w_t .

Although an exact expression for a for all values of $\frac{B_2}{B_1}$ would be very complex, the following is almost exact for ordinary values of $\frac{B_2}{B_1}$:—

$$a = \frac{w_t + \frac{2B_2}{B_1}w_d}{30B_2} \cdot \frac{l^3}{12E} \dots \dots (9)$$

It is not obvious which arrangement of loading gives the greatest value of a , so a few cases must be considered.

Case (c). Bays 1 and 3 loaded.

From Appendix I. 8,

$$a = \frac{(3w_t - 2w_d)}{10B} \cdot \frac{l^3}{12E} \dots \dots (10)$$

when $B_1 = B_2 = B_3$.

As before, the case has also been studied when the end beams are stronger and stiffer than the middle beam, and for

$$\frac{B_2}{B_1} = \frac{B_2}{B_3} = 0.8$$

$$a = \frac{(3w_t - 2w_d)}{11.5B_2} \cdot \frac{l^3}{12E} \dots \dots (11)$$

(Appendix I. 8.)

In general, for ordinary values of $\frac{B_2}{B_1}$,

$$a = \frac{(3w_t - 2w_d)}{\left\{ 10 + 7.5 \left(1 - \frac{B_2}{B_1} \right) \right\} B_2} \cdot \frac{l^3}{12E} \text{ approximately. } (12)$$

Case (b). Bays 2 and 3 loaded.

From Appendix I. 8, the impressed slope on column 2 when bays 2 and 3 are loaded is given by

$$a = \frac{4w_t - 7w_a}{30B} \cdot \frac{l^2}{12E} \dots \dots (13)$$

$$\text{for } B_1 = B_2 = B_3$$

$$\text{and for } \frac{B_2}{B_1} = \frac{B_2}{B_3} = 0.8$$

$$a = \frac{4w_t - 6.9w_a}{33.3B_2} \cdot \frac{l^2}{12E} \dots \dots (14)$$

and in general, for ordinary values of $\frac{B_2}{B_1}$, approximately

$$a = \frac{4w_t - 7w_a}{\left\{ 30 + 16.5 \left(1 - \frac{B_2}{B_1} \right) \right\} B_2} \cdot \frac{l^2}{12E} \dots (15)$$

Comparing equation (13) with (10)—bays 1 and 3 loaded—it will be seen that the latter gives by far the greater slope, except when $w_t = w_a$, when the two values are of course equal.

Case (d). Bay 2 loaded. From Appendix I. 8,

$$a = \frac{(2w_t - 3w_a)}{10B} \cdot \frac{l^2}{12E} \dots \dots (16)$$

$$\text{for } B_1 = B_2 = B_3.$$

$$\text{When } \frac{B_2}{B_1} = \frac{B_2}{B_3} = 0.8$$

$$a = \frac{(2w_t - 3w_a)}{11.5B_2} \cdot \frac{l^2}{12E} \dots \dots (17)$$

In general, for ordinary values of $\frac{B_2}{B_1}$

$$a = \frac{(2w_t - 3w_a)}{\left\{ 10 + 7.5 \left(1 - \frac{B_2}{B_1} \right) \right\} B_2} \cdot \frac{l^2}{12E} \dots (18)$$

An inspection of formulæ (16) to (18) will show that the bending stress on the columns will always be less for bay 2 loaded than for bays 1 and 3 loaded, except when $w_t = w_a$, when of course it is the same for both. We may therefore take equations 10 to 12 as giving the worst conditions of bending on the columns.

The value of the reaction with bays 1 and 3 loaded may be taken as

$$R = 0.55l(w_t + w_d).$$

(B) When the stiffness of the columns is so great that it has to be taken into account in the calculation of the slope produced at the supports.

Without further explanation, the results which are fully worked out in Appendix I. 8 may be stated, the treatment being exactly similar to that already given.

Case (c). Bays 1 and 3 loaded.

When $B_1 = B_2 = B_3$,

and $K_2C_2 = K_3C_3$,

$$a_2 = \frac{l^2}{12E} \cdot \frac{1.5w_t - w_d}{KC + 5B} \dots (19)$$

When $\frac{B_2}{B_1} = \frac{B_2}{B_3} = 0.8$,

and $K_2C_2 = K_3C_3$,

$$a_2 = \frac{l^2}{12E} \cdot \frac{1.5w_t - w_d}{KC + 5.75B} \dots (20)$$

It has been shown that this loading gives the greatest eccentricity, and the direct reactions will not differ greatly from those obtained by use of the formula on p. 140.

The above formulæ are also considerably simpler than those for other conditions of loading, and we must admit being unwilling devotees in the temple of mathematics. The formulæ for other conditions are, however, given in Appendix I. 8 should they be required.

III. Four or more spans.—In the case of beams of four or more spans, free at the ends, it is sufficiently accurate to treat the outer two columns—not meaning wall columns, of course, which are supposed to be replaced by brick walls or the like—in the same way as the corresponding columns under beams of three spans have been treated.

It will be found that for the columns inside these again—of which there is but one in the case of four spans—the formulæ for three spans would give a greater eccentricity than is actually produced, and such columns may be treated as follows. It will be found that the influence of the end spans

on the eccentricity in such columns is very small, and we may therefore apply the formulæ for the slope at a column under a beam of an infinite number of spans, in which the conditions of symmetry simplify the expressions considerably.

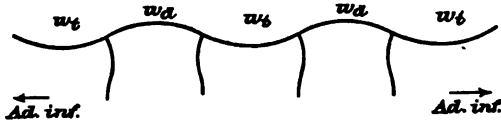

FIG. 76.

Thus, the columns under such a beam, illustrated in Fig. 76, have a slope induced in them of the value (Appendix I. 10)

$$a = -\frac{l^2}{12E} \cdot \frac{w_t - w_d}{(KC + 4B)} \dots \dots (21)$$

It may be noticed that $(w_t - w_d)$ is the live load on the beam, so that the formulæ may be written

$$a = -\frac{l^2}{12E} \cdot \frac{w_t}{KC + 4B} \dots \dots (22)$$

Eccentricities on Inside Columns when the Ends of the Beams are partially restrained.

All the foregoing formulæ apply, as stated, to the columns under a beam whose ends are free—i.e. rest on brick walls, for example.

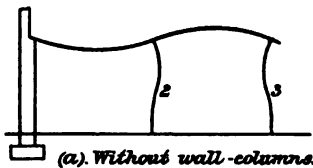

Cases frequently occur, however, when the ends of a beam of many spans are supported by wall columns, and are partially restrained by them. Such restraint affects the eccentricities on the interior columns.

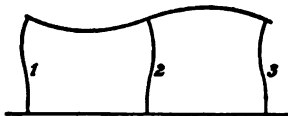

FIG. 77.

In Fig. 77, for example, the formulæ given apply to the construction illustrated in (a), and a little consideration will show that in column 2, at any rate, the maximum eccentricity will be reduced in the form of construction

illustrated in (b).

In columns more remote from the walls 3, 4, and so on,

this reduction is very small, and the same formulæ may be used without any sacrifice of economy.

The use of the same formulæ in the case of column 2 will always be on the side of safety, and it must be remembered that the stiffness of the outer columns is generally much less than that of the interior columns, at any rate for the lower tiers in a building of several stories, owing to the area of floor supported by the columns being generally only one half.

In any particular case in which it is desired to take this factor into account, the correct expression may be derived from the general formulæ in Appendix I.

II. OUTSIDE COLUMNS.

As for interior columns, the method adopted is to calculate the slope of the beam at its junction to the column, from which the stress due to bending may be calculated.

This slope depends not only on the properties of the column and of the end beam, and the method of loading of the latter, but also to some extent on the conditions of loading and the stiffness of the adjacent interior beams, and for that reason the design of an outside column is not independent of the number of spans in the building.

Case I. Single span.—When a simple arrangement of a beam supported on two columns is loaded, as shown in Fig. 78 (a) and (b), the slope of the beam at the end, neglecting the stiffness of the column, is, from Appendix I. 5,

$$\alpha_1 = \frac{w_l}{2B} \cdot \frac{l^2}{12E} \dots \dots \dots (23)$$

where $B = \frac{\text{moment of inertia of beam}}{\text{span}}$ as before.

The moment in the column

$$M = E_a K C$$

where, as before, $C = \frac{\text{moment of inertia}}{\text{length of column}}$,

$K =$ a constant, depending on the condition of the other end of the column, and having values for different cases, as given in Fig. 70.

The reaction is, of course,

$$R_2 = \frac{w_1 l}{2}$$

and the stresses are therefore easily calculated as in the previous examples.

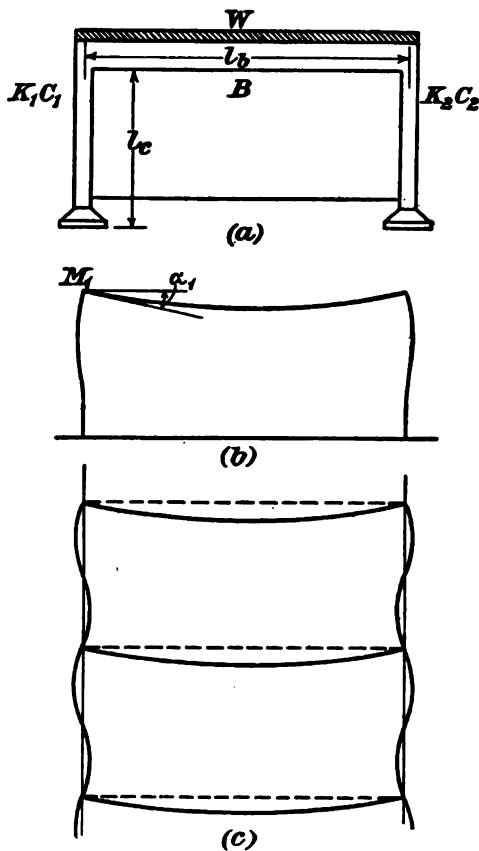

FIG. 78.

When resting on a footing of considerable area, the authors think that the lower end of the column may be considered as fixed, when $K = 4$.

When the columns are so stiff that it is desired to take their stiffness into account in determining the slope at the joint,

$$a = - \frac{w_t}{KC + 2B} \frac{l^2}{12E} \cdot \cdot \cdot \quad (24)$$

when the two columns have the same value of KC .

When, however, this varies for the two columns,

$$a_1 = - \frac{w_t(K_2C_2 + 6B)}{(K_1C_1 + 4B)(K_2C_2 + 4B) - 4B^2} \frac{l^2}{12E} \cdot \quad (25)$$

$$\text{and } a_2 = \frac{w_t(K_1C_1 + 6B)}{(K_2C_2 + 4B)(K_1C_1 + 4B) - 4B^2} \frac{l^2}{12E} \cdot \cdot \quad (26)$$

$$\text{and } M_1 = K_1C_1Ea_1$$

$$M_2 = K_2C_2Ea_2$$

When several floors exist, as in Fig. 78 (c), the condition has usually to be provided for in which the floors are simultaneously loaded. All the above formulæ apply to such a condition, but K is to be taken as = 6,* and the value of K_1C_1 must include for columns both above and below the beam in question.

An example will illustrate the method to be followed, and will also show the order of the stress in the columns due to bending. Consider the structure shown in Fig. 79.

Live load, 200 lbs./ft.²

Dead „ 100 lbs./ft.²

Beams and columns, 10 ft. pitch.

Here we have

Live load per beam = 2000 lbs. per foot run,

Dead „ „ = 1000 „ „

∴ w_t per inch = $30\frac{0}{2}^0 = 250$ lbs.

Taking the available width of concrete slab acting as the compression boom of the T-beam as

$$\frac{3}{4} \times 10 \text{ ft.} = 90 \text{ ins.}$$

$$\left(\text{Note, } \frac{\text{span}}{3} = \frac{25 \times 12}{3} = 100 \text{ ins.} \right),$$

* Strictly speaking, $K = 6$ assumes that the slope at the end of different floors is equal. This is not quite accurate, as the slope generally diminishes in the lower floors, owing to the increased stiffness of the columns, and in particular the topmost beams are restrained by the columns below them only, whereas all other beams are restrained by columns both above and below.

By a simple process of trial and error the exact value of K for any particular case may readily be determined, but generally no great error is made by taking it to be 6 for the conditions of loading under consideration.

$$\text{the equivalent percentage } p = \frac{8.94 \times 100}{90 \times 21} = 0.475,$$

and the depth of the neutral axis = $0.313 \times 21 = 6.6$ ins.

$$\text{Hence the I of steel about the neutral axis} \left. \vphantom{\begin{matrix} \text{Hence the I of steel} \\ \text{about the neutral axis} \end{matrix}} \right\} = 8.94 \times (14.4)^2 \times 15 = 27,700 \text{ ins.}^4$$

$$\text{I of concrete about the neutral axis}^* \left. \vphantom{\begin{matrix} \text{I of concrete about} \\ \text{the neutral axis}^* \end{matrix}} \right\} = \frac{bd^3}{3} = \frac{90 \times 6.6^3}{3} = 8,600 \text{ ,,}$$

$$\text{Total I of beam} = 36,300 \text{ ,,}$$

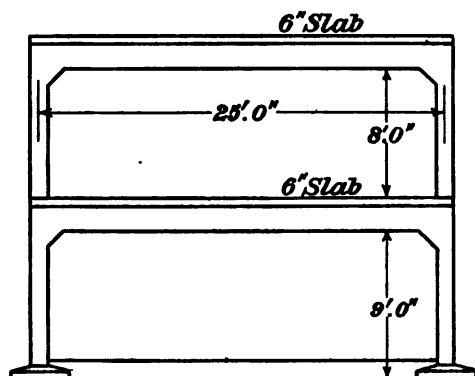

FIG. 79.

Designing the upper columns, we have

$$\text{load} = 12\frac{1}{2} \times 3000 = 37,500 \text{ lbs.}$$

$$\begin{aligned} \text{Equivalent area of } 10'' \times 10'' \text{ column with } 4 - \frac{3}{4}'' \text{ bars} \\ &= 100 + 14 \times 4 \times 0.44 \\ &= 124.6 \text{ ins.}^2 \end{aligned}$$

$$\therefore \text{nominal stress} = \frac{37,500}{124.6} = 300 \text{ lbs./ins.}^2.$$

I of column—

$$\text{from concrete} = \frac{bd^3}{12} = \frac{10,000}{12} = 833 \text{ ins.}^4$$

$$\text{from steel} \dagger = 1.76 \times (3)^2 \times 14 = \frac{221}{1054} \text{ ,,}$$

$$\therefore KC = \frac{K \cdot I_c}{l_c} = \frac{6 \times 1054}{96} = 65.8 \text{ ins.}^3$$

$$B = \frac{I_b}{l} = \frac{36,300}{300} = 121 \text{ ins.}^3$$

* Neglecting the very small error owing to the underside of the slab not coming quite down to the neutral axis.

† Taking 3" as distance from C.L. of column to C.L. of steel bars.

Hence, from formula (24),

$$\begin{aligned}
 E\alpha &= -\frac{w_0 l^2}{12} \cdot \frac{1}{KC + 2B} \\
 &= -\frac{250 \cdot (300)^2}{12} \cdot \left(\frac{1}{65.8 + 242} \right) \\
 &= -6070 \\
 \therefore f &= \text{stress due to bending} \\
 &= \frac{K \cdot y \cdot E\alpha}{l_0} \\
 &= \frac{6 \times 5'' \times 6070}{96} \\
 &= 1900 \text{ lbs./ins.}^2
 \end{aligned}$$

$$\begin{aligned}
 \text{Hence maximum stress in column} &= 1900 + 300 \\
 &= 2200 \text{ lbs./ins.}^2
 \end{aligned}$$

It will be seen that, while the stress due to direct load is only about half that usually allowed, the actual stress developed is practically the ultimate stress of the concrete.

The example taken is one in which the stress due to bending is perhaps rather greater than is frequently found in practice, as 25 ft. is rather above the usual span, and perhaps 8 ft. is rather less than the usual head room. It is thought, however, that the example illustrates in the most forcible manner the extreme importance of calculating these secondary stresses.

It should be pointed out that where the stress due to bending much exceeds that due to the direct load, the method given for the calculation of the bending stress is not correct, since when considerable tension exists on one side of the column, the material cannot be accurately treated as a homogeneous material.

The stress in the column due to bending may be reduced by any of the following methods:—

1. By haunching to the beam.*

* This haunching must, however, be carefully designed. It may be shown that some shapes of haunches, although reducing the beam stresses, may increase the stresses in the column due to bending, so that indiscriminate haunching does not necessarily add to the strength of the structure.

This, however, frequently clashes with an architect's scheme of decoration.

2. By increasing the size of the column.

This is the most obvious method, and yet sometimes the least effective. When, as in the present case, the slope of the beam is not greatly affected by the increase in size of the column, it may be found that an increase in the depth of the column may actually increase the stress. This is not so, however, when the stiffness of the column is great compared to that of the beam. An increase in the breadth of the column is more effective than an increase in depth.

3. By using a high percentage of longitudinal steel in the column.

4. By increasing the transverse binding in the column.

The two last are frequently the most effective methods.

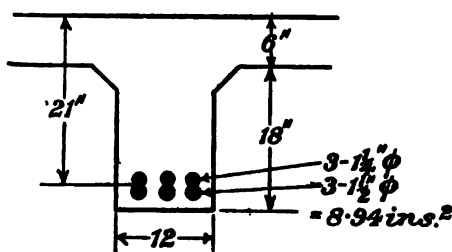

FIG. 79A.

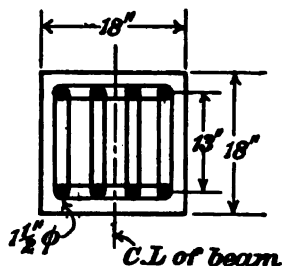

FIG. 79B.

With the latter method the stress is not reduced, but the concrete is rendered capable of withstanding a high longitudinal stress.

If we try a revised design with the columns in the upper tier 18" x 18" with eight 1½" bars, as in Fig. 79B,

I of column,

$$\text{Concrete } \frac{bd^3}{12} = \frac{18^4}{12} = 8,700 \text{ ins.}^4$$

$$\text{Steel } (8 \times 1.76)(6\frac{1}{2})^2 \times 14 = \frac{8,300}{17,000} \text{ ,,}$$

$$KC = \frac{K \cdot I_c}{l_c} = \frac{6 \times 17,000}{96} = 1060 \text{ ins.}^3$$

As before

$$B = 121 \text{ ins.}^3$$

From formula (24),

$$\begin{aligned} E\alpha &= -\frac{w_t l^2}{12} \cdot \frac{1}{KC + 2B} \\ &= -\frac{250(300)^2}{12} \cdot \frac{1}{1060 + 242} \\ &= -1440. \end{aligned}$$

$$\therefore f = \frac{K_1 \cdot y \cdot E\alpha}{l_c} = \frac{6 \times 9 \times 1440}{96} = 810 \text{ lbs./ins.}^2$$

$$\text{The stress due to direct load} = \frac{37,500}{324 + 196} = 72 \text{ lbs./ins.}^2$$

Hence maximum stress = 882 lbs./ins.²*

It will be seen that this is still a high stress, which might, however, be passed if a rich concrete and very ample binding at small intervals were used.

A haunch between column and beam is necessary.

It will be obvious from this that the size of these outside columns is determined much more by considerations of bending than by those of direct load.

Consider now the columns at the joint with the lower beams. The lower tier columns may be as in Fig. 79B, and let us consider first the case of both floors loaded.

Then we have,

$$KC \text{ for upper tier} = \frac{K \times I_c}{l_c} = \frac{6 \times 17,000}{96} = 1060 \text{ ins.}^3$$

$$KC \text{ for lower tier} = \frac{4 \times 17,000}{108} = 630 \text{ ,,}$$

$$\underline{\hspace{10em}} \\ 1690 \text{ ,,}$$

From formula (24),

$$\begin{aligned} E\alpha &= -\frac{250(300)^2}{12} \cdot \frac{1}{1690 + 242} \\ &= -970. \end{aligned}$$

* Calculating the maximum stress exactly by method of Chap. III., p. 69.

$$M = 1060 \times 1440 = 1,525,000 \text{ lb.-ins. } e = \frac{1,525,000}{87,500} = 40.7. \frac{e+f}{d} = 8.04.$$

Assume $n = 7.5$ ". Comp. in concrete = 54c. Comp. in steel = 65c. Theoretically increase width of beam to 40 ins. $p' = 1.18$, $t_1 = 16.25$, $a = 0.84 \times 15.5 = 13$ ins., $t = \frac{87,500}{7} \times \frac{47.2 - 13}{18} = 14,100 \text{ lbs./ins.}^2$ $c = \frac{14,100}{16.25} = 870 \text{ lbs./ins.}^2$

Therefore stress due to bending immediately *above* the floor,

$$f_1 = \frac{6 \times 9 \times 970}{96} = 547 \text{ lbs./ins.}^2$$

Stress due to bending immediately *below* the floor,

$$f_2 = \frac{4 \times 9 \times 970}{108} = 323 \text{ lbs./ins.}^2$$

Stress due to direct load in

$$\begin{aligned} \text{upper tier } f_3 &= 72 \text{ as before,} \\ \text{lower tier } f_4 &= 144. \end{aligned}$$

Hence maximum stress in upper tier immediately above the floor

$$f_1 + f_3 = 619 \text{ lbs./ins.}^2$$

And the maximum stress in lower tier immediately below the floor

$$f_2 + f_4 = 467 \text{ lbs./ins.}^2$$

Considering next the case of the lower beams loaded, and the upper beams unloaded.

When K for the upper tier may be taken as 4—

$$\text{KC for upper tier} = \frac{4 \times 17,000}{96} = 710 \text{ lbs./ins.}^2$$

$$\text{KC for lower tier} = \frac{4 \times 17,000}{108} = 630 \quad \text{,,}$$

$$\overline{1340} \quad \text{,,}$$

$$\begin{aligned} E\alpha &= - \frac{250(300)^2}{12} \cdot \frac{1}{1340 + 242} \\ &= - 1180. \end{aligned}$$

Then (with symbols as before),

$$= \frac{4 \times 9 \times 1180}{96} = 443 \text{ lbs./ins.}^2$$

$$f_2 = \frac{4 \times 9 \times 1180}{108} = 393 \quad \text{,,}$$

f_3 and f_4 are less than before, since the upper floor is unloaded, and equal 48 and 120 lbs./ins.² respectively.

$$\begin{aligned} \therefore \text{Maximum stress in upper tier} &= 443 + 48 = 491 \text{ lbs./ins.}^2 \\ \text{,, ,, lower ,,} &= 393 + 120 = 513 \text{ ,,} \end{aligned}$$

It will be seen from this that the stress in the lower portions of the column is considerably less than at the joint with the top beams. At this top joint the stress due to bending is relatively high owing to the much less restraint afforded to the beam than at the lower floors. If, however, the load on the top beams were less than in the lower beams, as would generally be the case where the upper beams support a roof load only and the lower beams a floor load, the stress due to bending would be much more equalized.

In that case it is found that in a good design, the dimensions of the outside columns do not vary greatly through several stories. This is, of course, in accordance with the most modern practice in the design of steel frame buildings, in which the same holds to a large extent.

Great care must be taken at the joints of the column bars in outside columns, which require to be strong in tension as well as in compression.

Case II. Two spans.—The greatest eccentricity on column 1 occurs when the left-hand bay is fully loaded, and the right-hand bay has its dead load only. Under these conditions (Fig. 80), the slope of the column is given by

$$a_1 = - \frac{l^2}{12E} \left[\frac{w_l \{ (K_1 C_1 + 4B)(K_2 C_2 + 10B) - 4B^2 \} - w_d \{ 2B(K_1 C_1 + 6B) \}}{(K_1 C_1 + 4B) \{ (K_1 C_1 + 4B)(K_2 C_2 + 8B) - 8B^2 \}} \right] \quad (27)$$

(See Appendix I. 7.)

This may be simplified for any particular ratio of $K_1 C_1$ to $K_2 C_2$.

Thus, when $K_1 C_1 = \frac{1}{2} K_2 C_2$,

$$a_1 = - \frac{l^2}{12E} \left\{ \frac{w_l (K_1 C_1 + 3B) - w_d B}{(K_1 C_1 + 4B)(K_1 C_1 + 2B)} \right\}. \quad (28)$$

From the slope, the stress may be calculated as in the previous case.

The above formulæ simplify very much when the columns are flexible in comparison to the beams, in which case the

value of KC becomes zero, and the formulæ so obtained give values for a_1 which are on the side of safety.

Putting $KC =$ zero,

$$a_1 = - \frac{l^2}{12E} \cdot \frac{3w_t - w_d}{8B} \dots \dots (29)$$

It should be noticed that under usual conditions w_t is four or five times w_d , and hence the latter is quite small compared

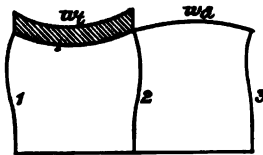

FIG. 80.—Two spans, one fully loaded.

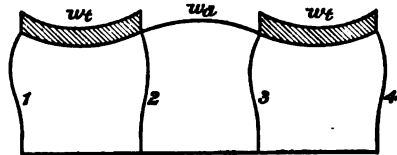

FIG. 81.—Three spans, centre unloaded.

to $3w_t$, and where great accuracy is not required the formula may therefore be reduced to

$$a_1 = - \frac{w_t l^2}{32BE} \dots \dots (30)$$

Comparing this with equation (23), it will be seen that the value of a_1 is 25 per cent. less for two spans than for one span.

Case III. Three spans and more.—The greatest eccentricity on the outside columns occurs when the end bays are fully loaded and the central bay is unloaded, under which conditions (Fig. 81) a general expression for a_1 involving K_1C_1 , K_2C_2 , B_1 and B_2 may be derived (Appendix I. 8).

It is, however, somewhat cumbersome, and the authors have therefore simplified it for two particular cases.

(a) $B_1 = B_2 = B_3$ and $K_1C_1 = K_2C_2$, etc.

$$\text{Then } a_1 = - \frac{l^2}{12E} \left\{ \frac{w_t(KC + 8B) - 2w_d B}{K^2 C^2 + 10KCB + 20B^2} \right\} \dots (31)$$

(b) $B_1 = B_2 = B_3$ and $K_2C_2 = K_3C_3 = 2K_1C_1 = 2K_4C_4$

$$a_1 = - \frac{l^2}{12E} \left\{ \frac{w_t(K_1C_1 + 4B) - w_d B}{(K_1C_1 + 2B)(K_1C_1 + 5B)} \right\} \dots (32)$$

In the cases in which the columns are slender, great simplification results from putting all the KC's = 0, when

$$a_1 = - \frac{l^2}{12E} \cdot \frac{4w_t - w_d}{10B} \dots \dots (33)$$

Where w_d may be neglected in comparison to $4w_t$, the formulæ further reduces to

$$a_1 = - \frac{w_t l^2}{30BE} \dots \dots (34)$$

It should be noted, by comparison of formulæ (30) and (34), how small, in such cases, is the difference in a_1 whether calculated for cases of two or three spans.

For a single span, the difference is somewhat greater: see formula (23).

In the case of four spans, the worst case for column 1 occurs with bays 1 and 3 live loaded, and bays 2 and 4 unloaded.

The actual effect of the fourth bay is to reduce the eccentricity of column 1, but the difference is extremely small, and the above formulæ may be used for four and any greater number of spans without appreciable error.

Value of the Eccentricity.—In the foregoing treatment of the stresses in columns, formulæ have been given for a , the slope produced by the bending of the beam at its junction with the column, and it has been shown how from this the bending moment and the stress on the column may be calculated. Although it is unnecessary in practice to calculate the value of the eccentricity, designers accustomed to steelwork calculations may find it a help to realize its value in any particular case. It may, of course, be obtained by dividing the bending moment in the column, which is given by the formula

$$M = KCEa$$

by the reaction on the column, which may generally, with sufficient accuracy for our present purpose, be taken as $\frac{wl}{2}$, in the case of outside columns.

It has been shown that for outside columns connected to

beams of three or more spans, the value of a_1 is given by the equation (31),

$$a_1 = - \frac{l^2}{12E} \cdot \frac{w_t(KC + 8B) - 2w_d B}{K^2 C^2 + 10KCB + 20B^2}$$

when $B_1 = B_2 = B_3$

and $K_1 C_1 = K_2 C_2$.

By the method indicated it is quite simple to calculate from this formula the actual value of the eccentricity in terms of the span, for any value of the ratio $\frac{KC}{B}$ and for any value of the ratio $\frac{w_t}{w_d}$, or these values may be taken from the curve of Fig. 82.

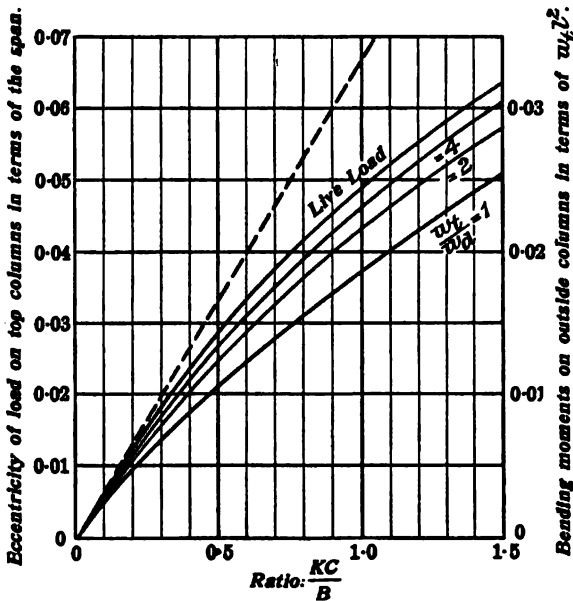

FIG. 82.—Eccentricity and bending moment on outside columns.

The notes on pages 132 and 135 should be read over carefully before values of K and KC are used in the above formulæ.

Formula (31) has been plotted in Fig. 82 for various ratios of $\frac{KC}{B}$ and $\frac{w_t}{w_d}$, the full lines giving the eccentricity calculated

by this formula. As a matter of interest, the dotted line has been added, showing the value of the eccentricity obtained by the formula

$$a_1 = - \frac{w_i l^2}{30BE}$$

which, as explained above, is a very simplified form obtained by neglecting the stiffness of the column in a calculation of the slope produced at the joint between the column and the beam, and also neglecting the term w_a in comparison to the term $4w_i$. It will be seen, as might be expected, from the simplifications involved, that the use of this formula always gives too high a value to the eccentricity, the error increasing with the increasing values of the ratio $\frac{KC}{B}$.

As already stated, the value of the eccentricity is not nearly such a useful quantity as the value of the moment in the column, since the former varies very greatly in different floors, while the latter, for any ratio of $\frac{KC}{B}$, is the same on the different floors. Hence a scale of moments, in terms of $w_i l^2$ has been added to Fig. 82, which will be found useful for reference.

PART III

THE DESIGN OF BEAMS AND SLABS

CHAPTER VIII

BEAMS

It has been shown in Chapters II. and IV. how the stress due to bending moments and shearing forces may be determined in a given beam. It remains to show how the magnitude of such bending moments and shearing forces may be calculated, and to mention some of the considerations which will guide a designer in the choice of the most suitable arrangement of section and reinforcement.

DETERMINATION OF SHEARING FORCES.

In the design of steelwork, the beams are generally unrestrained at their ends, and are almost invariably so treated, in which case the calculation of bending moments and shearing forces is perfectly simple and determinate. In reinforced concrete, however, the beams are generally continuous, and the bending moments and shears are then less easily calculated. As regards the total shear on a vertical section of a beam, this is affected to some extent by the fact that the beam is continuous, since when the negative moments at the ends of the beam are unequal—as they will be where the two adjacent beams are under different conditions of loading or have a different stiffness*—the reactions from the beam are affected by such inequality.

* See also Chap. VI. The stiffness of a number is proportional to $\frac{I}{l}$.

Thus in Fig. 83 the negative moment at the right end of bay 2 will be much greater than at the left end, owing to bay 3 being loaded and bay 1 being unloaded, and consequently the reaction and shear at the right end will exceed $\frac{wl}{2}$, whereas that at the left end will be less than $\frac{wl}{2}$.

The extent of such variation is given in Chap. VI. (p. 122), for various numbers of spans.

For an infinite number of spans it is $0.583wl$ for the live load, and $0.5w_d l$ for the dead load, and it varies proportionately

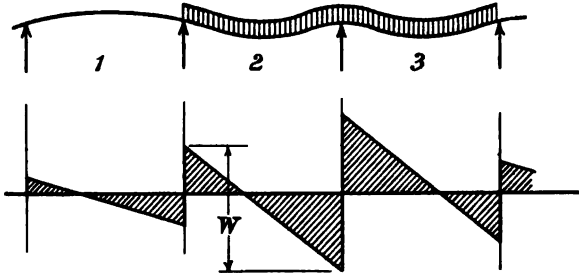

FIG. 83.—Shearing force diagram.

between these values, which may with sufficient accuracy be used for any number of spans greater than three. The maximum excess of the shear over $\frac{wl}{2}$ in such cases is therefore 16.6 per cent., and proportionately less when the dead load is appreciable, and many designers neglect it and take the shearing force as $\frac{wl}{2}$.

DETERMINATION OF BENDING MOMENTS.

The effect of continuity on the bending moment may now be considered.

It is usual, in calculating the bending moment in a beam, to neglect the continuity of the beam with the column. This gives results on the side of safety, and, as regards interior bays at any rate, does not involve any serious sacrifice of economy.*

* It may be noted here that this continuity cannot be neglected in the design of the column, because this would not give results on the side of safety.

There would be no difficulty in the design of continuous beams if the conditions of loading were constant. Unfortunately, however, this is generally not so, and a beam may generally be loaded in one span without the adjacent spans being loaded.

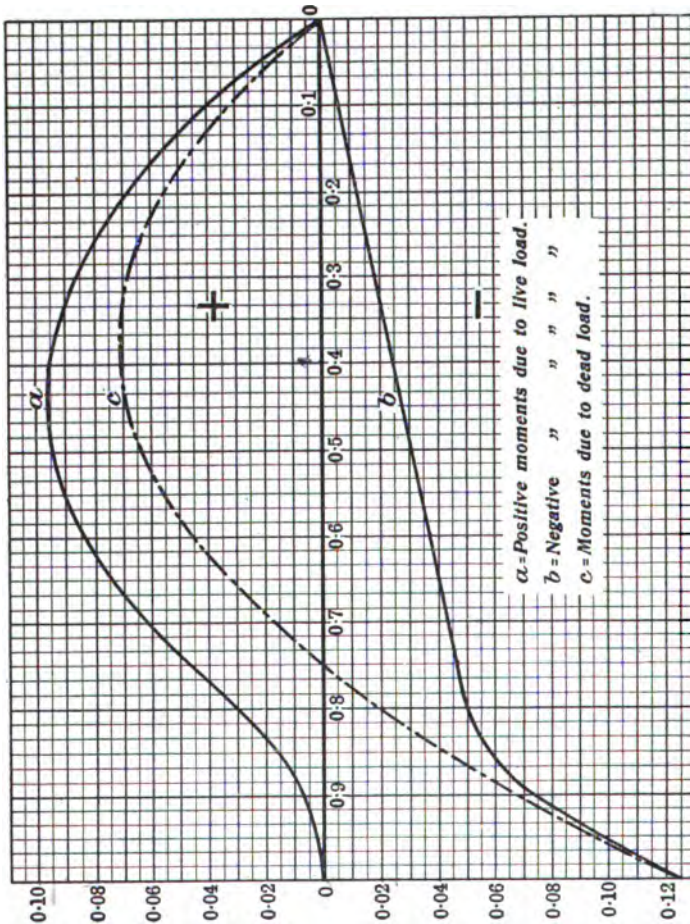

FIG. 84.—Two spans, right-hand half.

It is shown in the Appendices how the bending moment may be calculated in any such case. Such calculations are, however, not simple, and for the complete solution of any particular case many different conditions of loading have to be considered.

For this reason it is convenient to have all these calculations made once and for all, and put in such a form that the results may be readily used. Such results were published by Winkler* and are made applicable for all ratios of live load to total load, and are made applicable for all ratios of live load to total load,

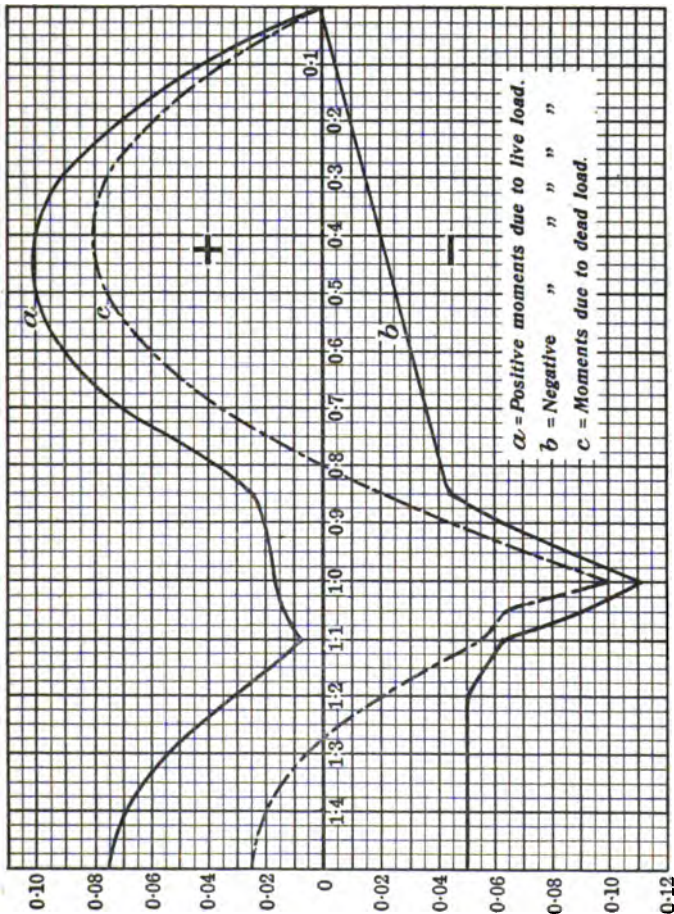

FIG. 85.—Three spans, right-hand half.

by separating the moments due to dead and live loads. The curves are given in Figs. 84, 85, and 86.

To properly understand the significance of these curves, it must be remembered that the curve for live load is not a

* *Vorträge über Brückenbau.*

bending moment curve for any single arrangement of loading, but that at any section of the beam the bending moment under several conditions of loading is considered, and the maximum and minimum value plotted.

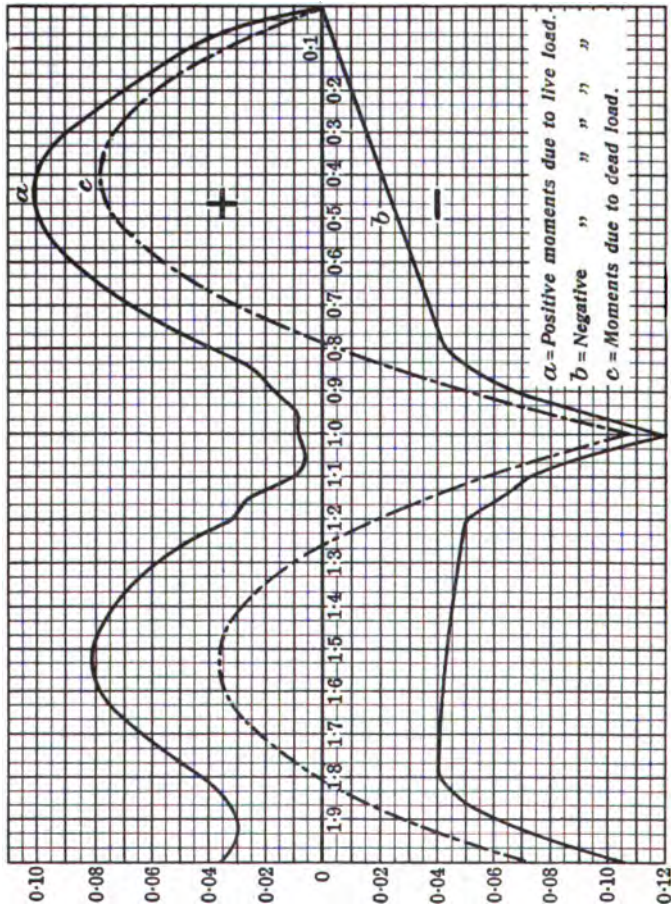

Fig. 86.—Four spans, right-hand half.

It is, of course, only necessary to plot the curves for one half, as the centre line shown is on the plane of symmetry.

It should be remembered that a positive bending moment indicates tension at the underside of a beam, and *vice versa*.

In what follows, the following notation will be used:—

w_l = live load per unit length,

w_d = dead " " " "

$w_t = w_l + w_d$ = total load per unit length.

Referring to Fig. 84, showing the moments in one half of a continuous beam of two spans, consider a point at a distance $0.4l$ from the freely supported end of the right-hand span.

Reference to the curve shows that the moment due to the live load may vary between $+0.095w_l l^2$ and $-0.025w_l l^2$. The first of these corresponds to the condition of loading in which the right-hand bay alone is loaded, and the bending moment curve is as in

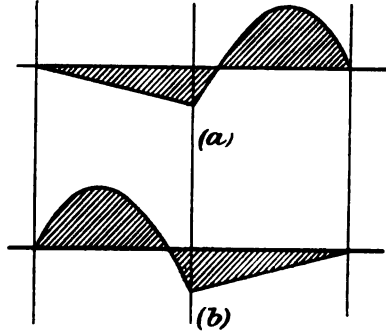

FIG. 87 (a) and (b).—Bending moment curve with two spans unequally loaded.

Fig. 87 (a), while the second value corresponds to the left-hand bay being loaded as in Fig. 87 (b). In addition to these moments, there is that due to the dead load, which reference to the curve shows us to be $0.07w_d l^2$ for the point in question.

Combining these moments, we see that the moment may vary between

$$0.07w_d l^2 + 0.095w_l l^2$$

$$\text{and } 0.07w_d l^2 - 0.025w_l l^2.$$

In a particular case in which

$$w_l = 1000 \text{ lbs. per ft. run}$$

$$w_d = 500 \text{ " " "}$$

the moment would therefore vary from

$$35l^2 + 95l^2 = +130l^2$$

to

$$35l^2 - 25l^2 = +10l^2.$$

When it is desired to express the moment in terms of $w_t l^2$, this may readily be done as follows:—

$$130l^2 = x \cdot l^2 w_t$$

$$x = \frac{130}{w_t} = \frac{130}{1500} = \frac{1}{11.5} \text{ or } 0.087$$

so that at this particular point the maximum positive moment is $\frac{w_t l^2}{11.5}$ for this particular ratio of w_t and w_a . Obviously in this case only the first value need be considered. In cases when the dead load is negligible, the lower value of the moment would, however, be negative, and it would then be necessary to see that there was enough steel in the top of the beam to resist it.

It must also be remembered in the case of T-beams that the slab is only effective when resisting positive moments, and that it may therefore be necessary to investigate the compressive stress at the bottom of the beam at mid-span, even though the negative moment is much smaller than the positive moment.

It will be found, of course, that near the points of support the negative moments predominate.

It is generally desirable to calculate the maximum and minimum values of the moments for several points in the beam, for the ratio of live load to dead load in any particular example, and to plot these values on a curve; since without this it is not obvious to what extent the moments due to live and dead load may counteract one another. It has already been shown in full how this is done in the case of a point 0.4*l* from the free end of a beam of two spans, and the remaining points are similarly calculated in Table I. on the opposite page.

These values are plotted in Fig. 88. The curve shows that with this particular ratio of w_t to w_a , the beam may be subjected to positive moments from $x = 0$ to $x = 0.85l$, and may be subjected to negative moments from $x = 0.5l$ to $x = l$ (measuring x from the free end); it also shows at a glance what moment of resistance must be provided in either direction at any point along the beam.

A similar curve may be constructed for different ratios of w_t and w_a and for different numbers of spans. When designing the actual bends in the reinforcing bars, reference to such a curve

TABLE I.—MAXIMUM AND MINIMUM MOMENTS. CONTINUOUS BEAM OF TWO SPANS FREE AT THE ENDS.

Case when $w_l = 2w_d$

$$w_l = w_l + w_d = 3w_d.$$

Distance from free end of beam. <i>l</i>	Moments from curve (Fig. 84).				Moments due to live loads in terms of dead load.			Combined live and dead load moments expressed in terms of dead load or total load.		
	Dead load.		Live load.		Max. $w_d l^2$	Min. $w_d l^2$	In terms of dead load.		In terms of total load.	
	$w_d l^2$	$w_l l^2$	Max. $w_l l^2$	Min. $w_l l^2$			Max. $w_d l^2$	Min. $w_d l^2$	Max. $w_t l^2$	Min. $w_t l^2$
0	0	0	0	0	0	0	0	0	0	0
0.1	+0.0925	+0.0887	-0.0062	-0.0125	+0.0775	-0.0125	0	0	+0.0866	+0.0066
0.2	+0.0550	+0.0675	-0.0125	-0.0187	+0.1350	-0.0250	-0.0900	0.0900	+0.0698	+0.0100
0.3	+0.0375	+0.0682	-0.0187	-0.0875	+0.1725	-0.0875	0.0800	0.0800	+0.0800	+0.0100
0.4	+0.0700	+0.0950	-0.0250	-0.0900	+0.1900	-0.0600	0.0200	0.0200	+0.0866	+0.0066
0.5	+0.0625	+0.0997	-0.0812	-0.0812	+0.1875	-0.0625	0.0	0.0	+0.0888	0.0
0.6	+0.0450	+0.0825	-0.0875	-0.0875	+0.1650	-0.0750	0.0800	0.0800	+0.0700	-0.0100
0.7	+0.0175	+0.0612	-0.0497	-0.0875	+0.1225	-0.0875	0.0700	0.0700	+0.0466	-0.0288
0.8	-0.0200	+0.0800	-0.0500	-0.0500	+0.0600	-0.1000	0.1200	0.1200	+0.0188	-0.0400
0.9	-0.0875	+0.0061	-0.0786	-0.0786	+0.0122	-0.1472	0.2147	0.2147	-0.0184	-0.0716
1.0	-0.1250	0	-0.1250	-0.1250	0	-0.2500	0.3750	0.3750	-0.0417	-0.1250

shows at a glance what proportion of the steel can be bent up from the lower side at any point, without exceeding the safe stress on the remaining bars.

Referring to Figs. 85 and 86, showing the moments for three

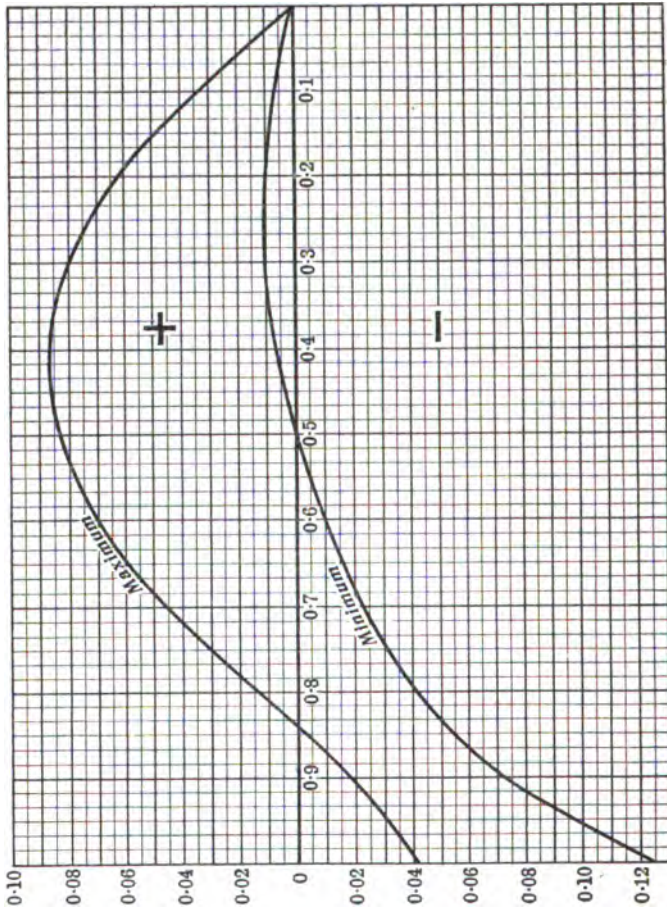

FIG. 88.—Continuous beam of two spans, free at ends, with $w_1 = 2w_2$.

and four spans, it will be noticed that the maximum moments due to live load have a positive value at the point of support. It is far from obvious under what conditions of loading this is obtained. Consider, however, three spans with the left-hand

bay loaded and the remaining two unloaded. The moment curve will then be as in Fig. 89, and will have a positive value at the right-hand point of support.

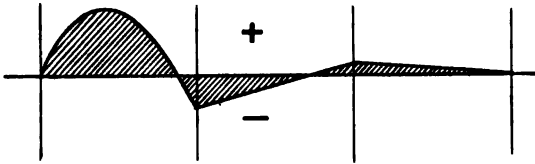

FIG. 89.—Bending moment curve for three spans, outside bay loaded.

SIMPLE FORMULÆ FOR CENTRE MOMENTS IN INTERIOR BAYS.

It has been suggested above that interior bays be treated from the curves of maximum moments in Figs. 84, 85, and 86. This is certainly a good method of treatment, since besides showing the value of the moment, positive and negative, to which *any* section may be subjected, it is extremely helpful when considering the bending up of bars, etc.

When it is only the central moment which is required, a simple expression is obtained by considering a beam of an infinite number of spans. The worst condition of loading (as regards midspan) that need be considered is for alternate bays loaded, as in Fig. 90.

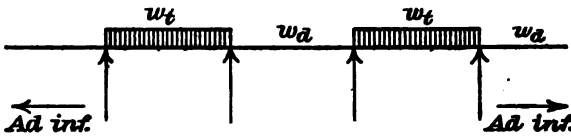

FIG. 90.—Uniformly distributed load on alternate bays.

(1) **Uniformly distributed loads.**—It is shown in Appendix I. 10 that the maximum positive moment at the centre of the span is

$$M = \frac{w_i l^2}{12} - \frac{w_a l^2}{24}.$$

The maximum negative moment or minimum positive moment at midspan is given by

$$M = \frac{w_a l^2}{12} - \frac{w_i l^2}{24}.$$

(2) **Triangular distribution of load.**—Beams are sometimes framed in such a way as to produce approximately square panels of slab supported on all sides by beams, as in Fig. 91.

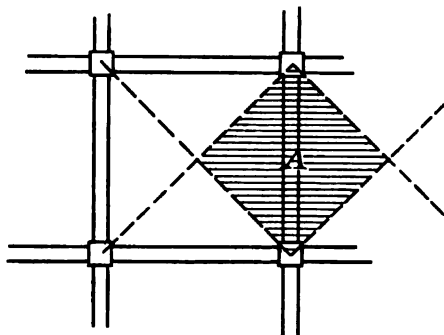

FIG. 91.

The load on the beam A will then be that due to the shaded area. Although some uncertainty exists as to the exact distribution of load on this beam, it is usually considered as increasing from zero at the ends to a maximum at the centre as shown by the figure. This is called a triangular distribution of load.

As the load per foot run is variable, it is convenient to give the formula in terms of the total load supported by the beam in pounds. The maximum positive central moment for a beam

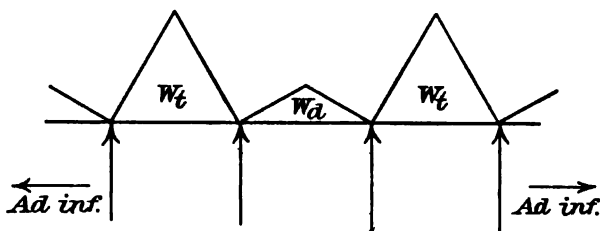

FIG. 92.

of any infinite number of spans, live loaded on alternate bays as in Fig. 92, is given by

$$M = \frac{l}{96}(11W_t - 5W_a) \quad (\text{Appendix I. 10.})$$

and the minimum positive or maximum negative moment at midspan by

$$M = \frac{l}{96}(11W_d - 5W_t)$$

where W_t = total load supported by beam,

W_d = dead load supported by beam.

It will be seen that for a given load to be supported, this distribution gives a higher moment than a uniform load on the same span.

(3) **Concentrated loads at midspan.**—Concentrated loads may occur on beams, either by the action of wheel loads or the like, or by the reaction on to a main beam from a secondary beam, as in Fig. 93.

Taking, as before, an interior bay of a beam with an infinite number of spans, we have from Appendix I. 14, the maximum positive moment at midspan,

$$M = \frac{l}{16}(3W_t - W_d)$$

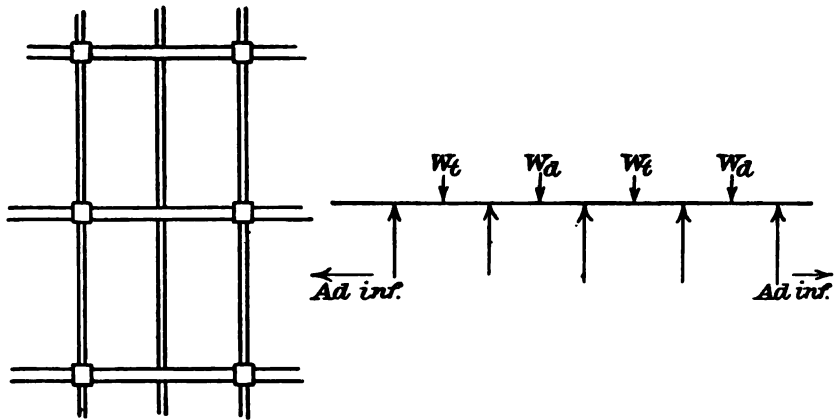

FIG. 93.

and minimum positive or maximum negative moment at midspan,

$$M = \frac{l}{16}(3W_d - W_t)$$

where W_t and W_d are the concentrated loads at the centre of the span.

(4). **Two concentrated loads at the third points.**—This frequently occurs, both from wheel loads of trucks having a wheel base about two-thirds of the span of the beam, but more particularly from the framing of beams shown in Fig. 94, which is very common for floors having columns about 20 ft. apart.

Denoting by—

W_t the total load supported by the main beam,

W_d the dead load supported by the main beam,

not including any load coming on the column directly, we have,

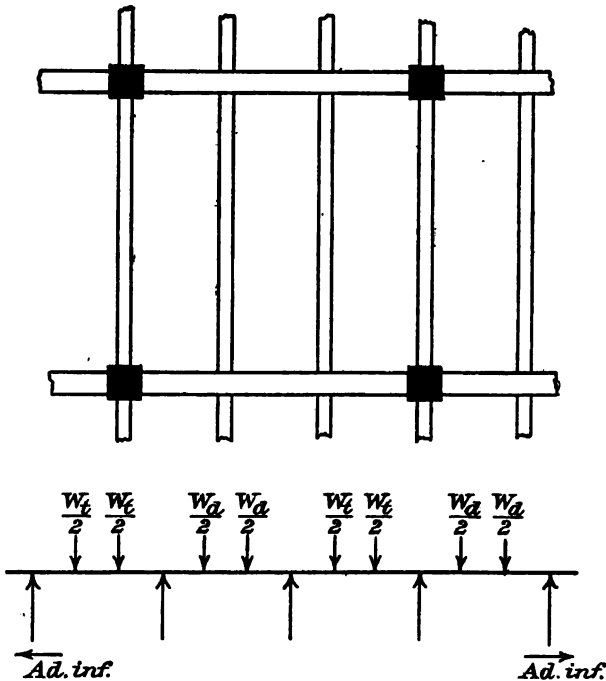

FIG. 94.

for alternate bays loaded in a beam with an infinite number of spans, as in Fig. 94,

$$M = \frac{l}{18}(2W_t - W_d) \quad (\text{Appendix I. 16.})$$

and the minimum positive or maximum negative moment is given by

$$M = \frac{l}{18}(2W_d - W_t).$$

CENTRE MOMENTS IN END BAYS.

These are best obtained from the curves of Figs. 84 to 86. In the case of beams having more than four spans, it is sufficiently accurate to use the curves relating to four spans.

In a few cases it is possible to allow a little restraint from the wall columns, but appreciable restraint is very rarely obtained where beams or slabs are built into brick walls, owing to the difficulty of getting the concrete packed right up to the top of the chase in the brickwork, and to the extremely small value of the deflection under full load.

SIMPLE FORMULÆ FOR NEGATIVE MOMENT AT INTERIOR COLUMNS.

It will be found that the negative moment in a beam at the point of support has generally a higher value than the positive value near midspan, and the beam obtains no help from the slab in resisting the compression stress at its lower surface. For this reason it is nearly always very desirable to provide adequate haunches between the beams and columns so as to increase the moment of resistance.

The value of these negative moments may be obtained from the curves in Figs. 84, 85, and 86.

$\frac{wl^2}{12}$ is a value quite commonly taken, and although unequal loading of different bays may produce a greater moment, the point on the bending moment curve is frequently rounded off by the width of the support, and for this reason the value of $\frac{wl^2}{12}$ will often be a sufficient allowance.

The correct value of this negative moment has been obtained in the Appendices for a beam considered to have an infinite number of spans under different conditions of loading. The

worst case which need be, and has been, considered, is when two adjacent bays fully loaded alternate with a single bay unloaded, as in Fig. 95, the greatest negative moment occurring, of course, at the support between the two fully loaded bays.

Reference to the Appendices will show that the value of this moment under different arrangements is as follows:—

(a) **Uniformly distributed load** (Fig. 95)—

$$M = -\frac{w_t l^2}{9} + \frac{w_a l^2}{36} \quad (\text{Appendix I. 11.})$$

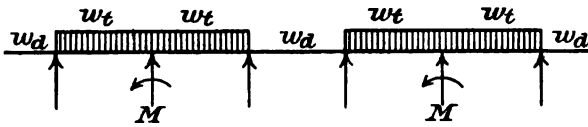

FIG. 95.

(b) **Triangular distribution of load** (Fig. 96)—

$$M = -\frac{5}{36} W_t l + \frac{5}{144} W_a l \quad (\text{Appendix I. 13.})$$

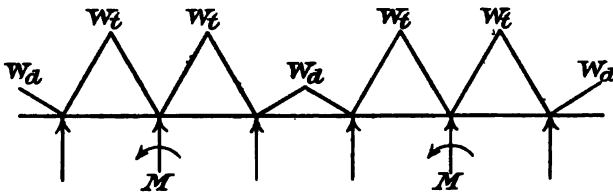

FIG. 96.

W_t and W_a being the total load supported by the beam in the loaded and unloaded bays respectively.

(c) **Concentrated load at midspan** (Fig. 97)—

$$M = -\frac{W_t l}{6} + \frac{W_a l}{24} \quad (\text{Appendix I. 15.})$$

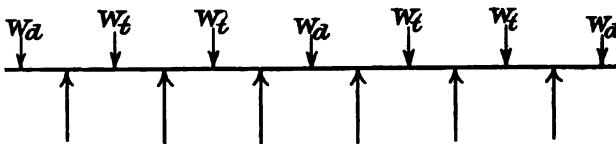

FIG. 97.

(d) Two concentrated loads at the third points (Fig. 98)—

$$M = -\frac{4W_1l}{27} + \frac{W_2l}{27} \quad (\text{Appendix I. 17.})$$

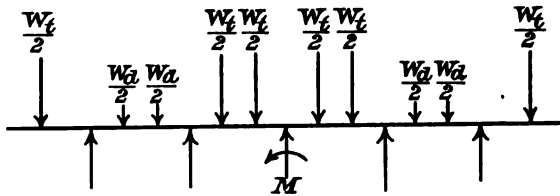

FIG. 98.

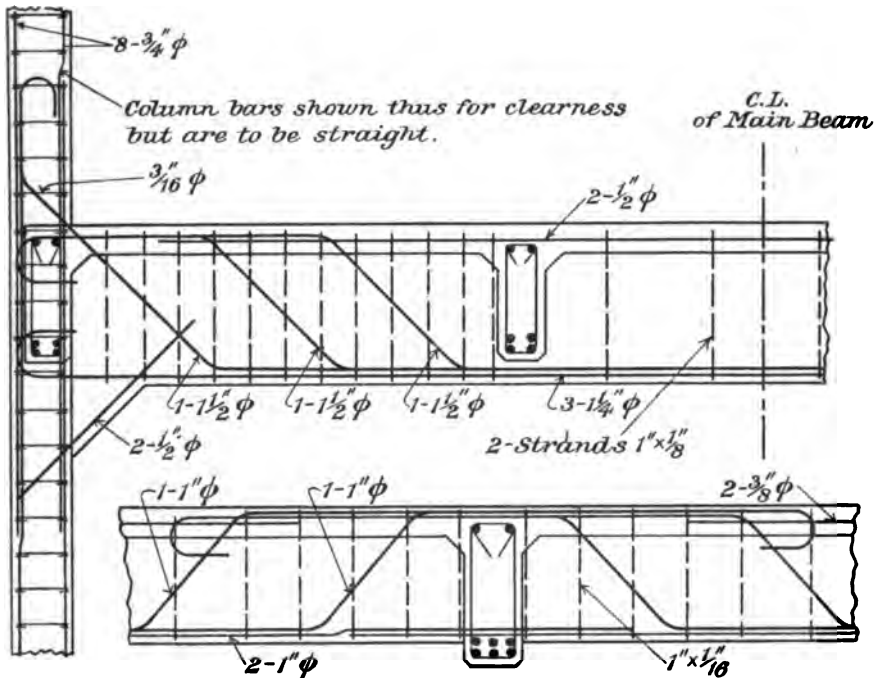

FIG. 99.—Half elevation and section of main beam at joint with outside column.

NEGATIVE MOMENTS AT OUTSIDE COLUMNS.

At the junction of the beam to the outside columns, where these are of reinforced concrete, the moments cannot be obtained

from the curves of Figs. 84, 85, and 86, since the latter are drawn for beams freely supported at the ends. The beam should, nevertheless, be designed to resist negative moments at these points, and the value of such moments is the same as that on the outside column, which may be determined by the principles of Chap. VII.

Note, however, that where a column exists above as well as below the beam, the negative moment on the beam will be the sum of the moments in the two tiers of the column.

Considerable care should be taken in the design of the junction between the beams and the outside columns, which is difficult in many respects.

One of the chief difficulties is to provide sufficient bond resistance to the end of the bars on the tension side—generally the upper one. Fig. 99 shows an arrangement of reinforcement at such a joint.

THE SIZE OF A BEAM.

To persons accustomed to steelwork designs, the size of a beam is a definite thing which may be obtained straight from a suitable table when the load and span are given. It must, therefore, be rather startling, when examining various schemes submitted by specialist firms to a common specification, to notice the very great variation in the size of reinforced concrete beams designed for the same conditions.

It will be found that a very great variation in size may be made, the strength being the same. Consider, for example, a floor beam of 25 ft. span supporting a panel 6 ft. wide carrying a total load of 300 lbs./ft.² The maximum Bending Moment and maximum Shearing Force may then be calculated in the manner indicated above.

Suppose now that the floor is 5 ins. thick—a common thickness—and that we determine arbitrarily the size of the beam, say 24" × 12" nett, under the slab.*

The area of steel required at midspan may easily be calculated, and an arrangement of bent-up bars and stirrups determined which will give the requisite strength in shear, in

* The size of a T-beam is usually given nett below the slab, and not in overall dimensions.

accordance with the methods and principles explained in Chap. IV. It will be necessary to see that the negative moment of resistance near the supports is sufficient, not only as regards the upper face—in tension—but also as regards the lower face, which is in compression. In the particular case given, a haunch would be necessary unless considerable compression steel were used.

A beam 18" × 12" could, however, also be made to give the required strength. Owing to the reduced radius arm, a larger area of steel would be required near midspan. It would probably be found, too, that the compressive stress in the slab exceeded the safe value, in which case some compression steel would be required. To obtain the necessary shearing resistance, more bent-up bars and more stirrups would be required, and at the supports a larger haunch would be necessary. The beam could, however, be made to have exactly the same factor of safety for the specified load.

It will be seen that the designer has a very free hand in the selection of the size of a beam. Nor does the consideration of cost limit his choice as much as might at first be supposed. The shallower beam will require less concrete and centering, but an increased quantity of steel, and within certain limits the difference in cost is very small. This is shown in the following example, in which the following stresses will not be exceeded:—

$$t = 16,000 \text{ lbs./ins.}^2$$

$$c = 600 \text{ lbs./ins.}^2$$

Design I.—A freely supported beam on a span of 18 ft. carries a concentrated load of 20 tons. Design a suitable beam.

Here the bending moment due to the live load—

$$M = \frac{Wl}{4} = 2,420,000 \text{ lb.-ins.}$$

If the beam is not reinforced in compression, we may adopt a percentage of steel of

$$p = 0.675,$$

in which case

$$\frac{M}{bd^2} = 95,$$

and consequently, if the total moment, including that due to the dead load of the beam, be taken as 3,000,000 lb.-ins, we have—

$$bd^2 = \frac{3,000,000}{95} = 31,600 \text{ ins.}^2$$

The actual size of the beam will now depend on what proportion is taken between b and d ; thus, if we take d as 30 ins.,

$$b = \frac{31,600}{900} = 35 \text{ ins.}$$

A much lighter beam is obtained if the depth is increased and the breadth reduced; thus if we take $d = 40$ ins.,

$$b = \frac{31,600}{1600} = 19.8, \text{ say } 20 \text{ ins.}$$

$$\text{The area of steel } A = \frac{0.675 \times 40 \times 20}{100} = 5.4 \text{ ins.}^2.$$

Six $1\frac{1}{8}$ -in. bars would therefore be a suitable arrangement of steel, and in this beam there is ample width to keep all the bars in one layer.

A cover of concrete of $2\frac{1}{2}$ ins. being assumed, the overall depth will then require to be 43 ins. It is now necessary to see if the allowance made for the dead weight of the beam was sufficient. The weight per foot run

$$w = \frac{43 \times 20 \times 150}{144} = 895 \text{ lbs. per foot run;}$$

consequently the bending moment due to dead load

$$M = \frac{wl^2}{8} = \frac{895 \times 324 \times 12}{8} = 435,000 \text{ lb.-ins.}$$

Adding to this the bending moment due to live load of 2,420,000, we have a total bending moment of 2,865,000, which it will be seen is slightly less than that assumed in the design.

Considering now the strength of the beam from the point of view of shear, we have—

Shear due to live load = 22,400 lbs.

„ „ dead load = 8,950 „

31,350 „

When this is divided by the effective area of the beam = $40'' \times 20'' = 800$ sq. ins., the shear per square inch is 39 lbs., which would therefore be safe without special precautions in the way of steelwork.

It is, however, desirable to bend up at least some bars at each end, as shown in Fig. 100, and to hook the ends of all

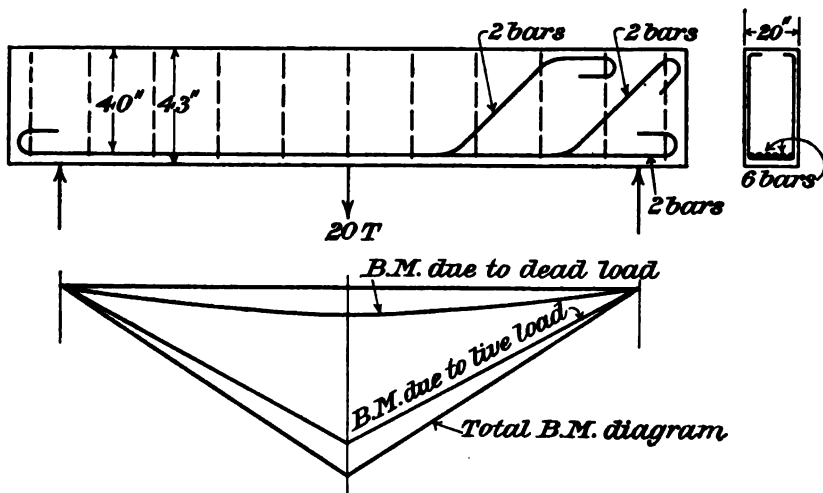

FIG. 100.—Example.

bars. An examination of the bending-moment diagram will show that bars may be bent up at the points indicated on the figure without exceeding the safe stress in the steel at any point.

Coming now to the question of adhesion, it will be seen that the bending moment at a point 12 ins. from the point or support is about 330,000 lb.-ins. As the radius arm of the beam is approximately $0.88 \times 40 = 35.3$ ins., the total tension required to resist this bending moment is

$$T = \frac{330,000}{35.3} = 9350 \text{ lbs.}$$

The whole of this tension has to be taken up in the adhesion of two $1\frac{1}{8}$ -in. bars on a length of 12 ins. The surface area of the bars on this length is $2 \times 3.53 \times 12 = 84.8$ sq. ins. As the adhesion will be practically constant over this length, we may take its value as being—

$$f = \frac{9350}{84.8} = 110 \text{ lbs./ins.}^2$$

It will be seen that this value is somewhat above that usually allowed. It would, however, be safe when the ends of the bars are well hooked, as shown in the figure. The safe value of the adhesion and the safety against failure by shear would be increased by the provision of a few stirrups. A suitable section would be $1'' \times \frac{1}{8}''$ bent in the form of a **U** and spaced at 2 ft. centres.

In this particular example it has been shown that the shear strength of the concrete is sufficient without bending up some of the bars. An alternative design would therefore be to bend up only two bars instead of four, as shown, and to leave four bars along the bottom of the beam at the end. If this were done the adhesion stress would be halved, since twice the area of the steel would be provided, and the total tension to be taken up in a given length would remain the same as before.

Design II.—Take the same loads and span as in Example I, but reduce the depth of the beam to a minimum by the insertion of compression steel, leaving the breadth as before. The easiest way to solve this is to assume a value for the depth, decide on the position of the compression reinforcement, and then calculate the area of compression steel required. Let us take—

$$d = 30 \text{ ins.}$$

The total bending moment to be carried will be somewhat less than in the last example, owing to the reduced dead weight of the beam, and approximately—

$$M = 2,800,000 \text{ lb.-ins.}$$

A stress of 600 lbs. in the concrete and of 16,000 in the steel being assumed, the radius arm will be $0.88 \times 30 = 26.4$ ins. Consequently the total tension—

$$T = \frac{2,800,000}{26.4} = 106,000 \text{ lbs.}$$

The area of steel required is therefore

$$A_t = \frac{106,000}{16,000} = 6.63 \text{ ins.}^2$$

Six 1½-in. bars would therefore be ample.

Coming now to the compression side, the total compression is 106,000 lbs. The depth of the neutral axis with the stresses assumed is $0.36 \times 30 = 10.6$ ins.; hence the compression taken by the concrete = $\frac{bnc}{2} = \frac{20 \times 10.6 \times 600}{2} = 63,600$ lbs.

This leaves 42,400 lbs. to be taken by the compression steel. If we put this 3 ins. from the upper edge of the beam, the stress in the concrete at this point will be—

$$c = \frac{600 \times 7.6}{10.6} = 430 \text{ lbs./ins.}^2$$

The stress on the steel will therefore be $430 \times 14 = 6020$ lbs./ins.²

Hence the area of compression steel required is $\frac{42,400}{6020} = 7.02$ sq. ins.

Six 1½-in. bars would therefore be suitable, and would give symmetrical reinforcement.

It may be noted here that in order that these bars may be effective they must be tied into the beam to prevent their tendency to buckle out of the concrete. For this case the spacing of the bindings might be decreased to 12 ins., and the top ends well lapped.

To form an *estimate of the relative costs* of the two beams designed in Examples I. and II. it will be sufficiently accurate to assume that the following unit costs apply to both equally:—

Concrete	30/- per cubic yard.
Steel	£12 per ton.
Shuttering	2/3 per square yard.
Stirrups	£20 per ton.

Assuming that 18 ins. bearing is given to the beam at either end, we may take out the quantities and costs of the two beams as follows:—

Example I.—Beam 43 ins. deep by 20 ins. wide, with six $1\frac{1}{2}$ -in. round bars at the centre.

Concrete:—

$$\frac{43'' \times 20''}{144} \times \frac{(20 + 2 \times 1.5)}{27} = 5.09 \text{ cub. yds.}$$

Steel:—

We may assume that owing to the bars which are bent up being somewhat shorter than those which are left straight and only hooked at the ends, the total quantity of steel will be approximately 90 per cent. of that required if all the bars ran the full length of the beam.

$$\frac{6 \times 3.4 \times (20 + 2 \times 1.5) \times 0.9}{2240} = 0.188 \text{ ton.}$$

Shuttering:—

The bearing will require no shuttering.

$$(2 \times 4\frac{3}{4}'' + 4\frac{9}{8}'')^2 \cdot 9 = 19.62 \text{ sq. yds.}$$

Stirrups:—

Assume No. 12 per beam 9 ft. long,

$$\frac{12 \times 9 \times 0.426}{2240} = 0.0205 \text{ ton.}$$

Hence the total cost of this beam will be

			£	s.	d.	
Concrete	... 5.09 cub. yds.	@ 30/-	=	7	13	0
Steel	... 0.19 ton	@ £12	=	2	5	0
Shuttering	... 19.62 sq. yds.	@ 2/3	=	2	4	0
Stirrups	... 0.0205 ton	@ £20	=	0	8	0
				£12 10 0		

Example II.—Beam 33 ins. deep by 20 ins. wide, with six $1\frac{1}{2}$ -in. bars top and bottom.

Concrete:—

$$\frac{33 \times 20}{144} \times \frac{23}{27} = 3.9 \text{ cub. yds.}$$

Steel:—

Taking in this case 60 per cent. of the compression steel and 90 per cent. of the tension steel, or 75 per cent. of the whole,

$$\frac{12 \times 4.21 \times 23 \times 0.75}{2240} = 0.39 \text{ ton.}$$

Shuttering:—

$$(2 \times \frac{33}{12} + \frac{29}{12}) \times \frac{20}{9} = 15.92 \text{ sq. yds.}$$

Stirrups:—

$$\frac{24 \times 9 \times 4.26}{2240} = 0.041 \text{ ton.}$$

Hence the total cost of the second beam will be—

			£	s.	d.
Concrete	3.9 cub. yds. @ 30/-	=	5	17 0
Steel	0.39 ton @ £12	=	4	14 0
Shuttering	15.92 sq. yds. @ 2/3	=	1	16 0
Stirrups	0.041 ton @ £20	=	0	16 0
				£13	3 0

The difference in cost of the second beam over the first is thus 13/-, or 5 per cent.

Owing to this elasticity in the size of its members, a concrete structure need never be ugly, and a good design is partly determined by considerations which lie outside the realm of engineering—using this term in its limited meaning. A competent designer requires, in fact, to be more than an engineer—he must have an eye for the beautiful, and “*de gustibus non disputandum est.*”

Leaving then, as we must do, the actual design to the aesthetic and other requirements of any particular case, a few considerations of a purely technical nature may be mentioned.

(a) A beam should not be too shallow in proportion to its span, or it will deflect unduly under its load. The usual rule for the design of steelwork is that the ratio of depth to span

$$\frac{d}{l} \text{ should not be less than } \frac{1}{20}.$$

This is based on a maximum deflection of $\frac{1}{600}$ of the span at a stress of 16,800 lbs./in.²

Where concrete beams are freely supported at their ends, the same rule may be adopted.*

Where, however, the beams are restrained at their ends, a smaller deflection is obtained, and hence under such conditions the ratio of $\frac{d}{l}$ may be decreased. Generally speaking, a ratio

of $\frac{d}{l} = \frac{1}{30}$ will not give an excessive deflection under usual working stresses for continuous beams.

(b) The sectional area of the beam should not be made too small in relation to the total shear to be resisted.

The R.I.B.A. Report of 1907 limited $\frac{S}{bd}$ to 120, while the same Report of 1911 leaves the point untouched.

It must be remembered that, whether bent-up bars or stirrups are used as the tensile element of the imaginary lattice girder (see Chapter IV.), the concrete is relied upon to form the diagonal compression members, which are an essential part of the girder. Hence it is obvious that where the ratio $\frac{S}{bd}$ is excessive, shear failure would occur by crushing of the concrete at the bends in the bars, though the reinforcement might be ample to guard against excessive stresses in the stirrups or bent-up bars.

Unfortunately, it is very difficult to give a value for $\frac{S}{bd}$ which should not be exceeded, as it varies very much with

* A concrete beam stressed to 16,000 and 600 has a less deflection than a steel joist stressed to 16,000 in both booms, since the deflection is proportional to the ratio of stress to distance from neutral axis. In the case of the steel joist this is $\frac{16,000}{d/2} = \frac{32,000}{d}$, and in the concrete beam it is $\frac{16,000}{0.64d}$ measured from the steel, or $\frac{600 \times 15}{0.36d}$ measured from the concrete, the two expressions being of course equal and having the value $\frac{25,000}{d}$.

In addition to this consideration, it is a fact that although the beam has to be designed for the whole of the tension to be taken by the steel, which condition obtains at a few points where small cracks have occurred, the concrete will take a certain fraction of the tension between such cracks, and will reduce the deflection accordingly.

For this reason, deflection tests of a concrete beam give considerably less indication of the stress than is the case with a steel girder.

the conditions of the beam. For a freely supported beam resting on supports which may spread, probably 120 is always a safe value, provided the arrangement of reinforcement is satisfactory in detail, and a fair proportion of the steel is carried straight along to the end of the beam to take up the diagonal compression. In continuous beams, however, especially when not subjected to very unequal loading, this ratio may be increased very considerably.

In any case, however, sufficient steel is to be supplied either as stirrups or bent-up bars to take up the whole shear, in accordance with the principles explained on p. 88, Chapter IV., some allowance being made for the existence of inclined compressions where these occur, and are adequately resisted.

INCREASE OF POSITIVE MOMENTS IN BEAMS DUE TO UNEQUAL SETTLEMENTS OF THE SUPPORTS.

The values of the moments given for different conditions in the preceding pages have assumed that the supports remain at the same relative level after loading. It is necessary to consider the magnitude of the error involved, since in practice this condition is not absolutely fulfilled. Thus some columns may, under certain loadings, be more severely stressed than others, and will therefore compress somewhat more. In the case of columns 50 ft. long stressed to 500 lbs./ins.², the shortening under load would be $\frac{50 \times 12 \times 500}{2,000,000} = 0.15$ in.

The relative shortening of two columns would therefore be under this value.

If the foundations are faulty, the relative subsidence may be very much greater. As a prudent engineer will not overload the foundations to a reinforced concrete building, these cases will not be considered.

Another cause of unequal settlement of supports may be the deflection of a main beam carrying the ends of a series of secondary beams. Consideration will show that relative settlements of about $\frac{1}{2}$ in. may occur under usual conditions

of spans and loads, and it is desirable to investigate the magnitude of their effect on the stresses.

As the subject is complicated, a single example will be taken. Consider, then, a beam of two spans, the ends resting on walls (considered as incompressible) and the centre supported by a main beam in which

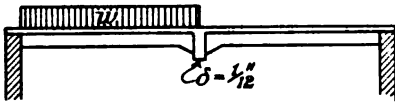

FIG. 101.—The deflection of the centre support of a beam of two spans.

a deflection of $\frac{1}{2}$ in. occurs, as in Fig. 101.

With the left-hand span loaded alone, a certain centre moment will exist, which may be calculated in the usual way. The deflection of the main beam will reduce the negative moment in the secondary beam, and will thereby increase the positive moment in the loaded way. To find the magnitude of this increase is the problem.

This is treated in Appendix I. 20, where it is shown that, neglecting the dead load, the positive moment is given by—

$$M = \frac{1}{2} \left(\frac{49}{256} w l^2 + \frac{9E^2 I^2 \delta^2}{w l^6} - \frac{21}{8} \cdot \frac{EI\delta}{l^2} \right)$$

The relative values of the last two terms in comparison to the first are a measure of the increase due to the deflection of the main beam. The neglect of the dead load, though affecting the value of the positive moment, has practically no effect on the increase due to deflection.

In our example, let $\delta = \frac{1}{2}$ in.
 $l = 21$ ft.

live load = 200 lbs./ft.²

distance apart of secondary beams = 7 ft.

Then $w = 200 \times 7 = 1400$ lbs./ft.

With a secondary beam 10 ins. deep (nett), a suitable design would give—

$$EI = 15.6 \times 10^9 \cdot \text{lbs./ins.}^2$$

Substituting all known values in the equation for the centre moment given above, we have—

$$M = 710,000 + 3000 + 24,000 \text{ lb.-ins.}$$

Hence the effect of the deflection is to increase the centre moment by 27,000, or 3·8 per cent.

BENT BEAMS.

The calculation of the strength of bent beams provides many interesting problems, in which a student with a taste for mathematics will find ample scope for its gratification. Some of these problems are so important that they must be referred to here, as affecting designs in no small degree.

Consider, first, a bent beam in which the tension face is concave, as in the roof beam shown in Fig. 102. If the walls are incapable of resisting a large thrust, the bending moment in

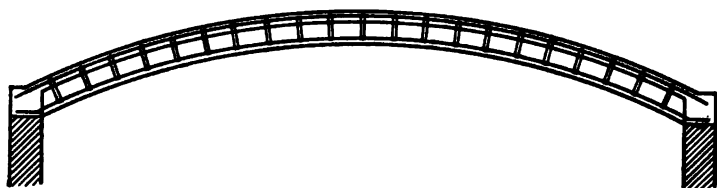

FIG. 102.—Bent beam.

the beam will be as great as if it were not of an arched shape, and the tension in the lower member is easily calculated in the usual manner.

Unless special care is taken to prevent it, the tension bars will tend to straighten themselves, and will burst through the small cover of concrete under them. This may, of course, be prevented by stirrups throughout their length at small intervals, such stirrups being easily calculated in terms of the tension and the curvature, and being, of course, additional to those required by considerations of shear.

In the arched beam illustrated, the curvature is so small that the stirrups required to prevent the tension member from straightening itself would be but a small item. It sometimes happens that the actual curvature in the bars is far from being as regular as shown on the drawing, owing to the bars being bent in transit and slinging, and in such cases the curvature may at some points be considerably greater than anticipated by

the designer. This applies also to some extent to straight beams.

For this reason it is well to allow a margin in all cases in the calculation of the stirrups required.

The tying in of a tension member on the concave side of a structure, easily provided for in cases of small curvature, becomes a serious problem when the curvature is very sharp. This may occur, for example, if a retaining wall be reinforced as in Fig. 103 (a).

It will be found that the area of stirrups required is very great, and it is generally very difficult to ensure adequate bond

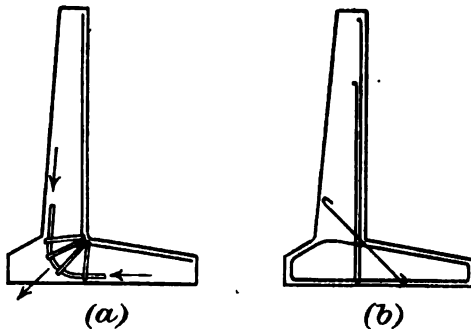

FIG. 103.—Reinforcement to a beam sharply bent.

or other fixing to these stirrups. When to this is added the possibility of their omission or displacement, the authors are of opinion that such a method of reinforcement is dangerous except under special conditions, and therefore advocate, in this case, the arrangement shown in Fig. 103 (b). This applies equally to cantilevered sides to reservoirs, tanks, and similar structures.

If, however, for any reason it is desired to use the arrangement of Fig. 103 (a), a further point requires attention. The compression forces at the front of the vertical slab and at the base of the heel, shown by arrows in the figure, have a resultant at their point of intersection, also shown by an arrow. It will be found that the magnitude of this resultant greatly exceeds that of the upward pressure of the earth at this point, and is, in fact, balanced by the tension in the stirrups in such a way as to cause the pressure curve to follow a circular course,

similar to that of the bar shown on the drawing. This will make clear the importance of adequate bonding of the stirrups in the compression area, and perhaps the best way to obtain this is to bend the stirrups round the curved bar, which must be big enough to distribute the pressure over a sufficiently large area of concrete to bring down the bearing pressure to a safe value.

In any case, it is very desirable to make the bend in tension bars as gradual as may be. This calls for a haunch, circular if possible, but where a haunch is undesirable, the bar should still be given a gentle curve, and a reduced depth of beam allowed for.

Consider now, a bent beam in which the tension face is on the convex side, and the compression face is concave, as, for example, in the cantilever shown by Fig. 104.

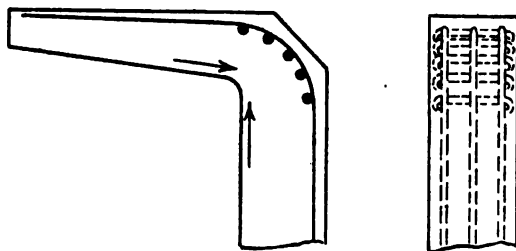

FIG. 104.—Reinforcement of a sharply bent cantilever.

In this case the curvature of the tension bars at the bend will produce radial compression forces, equilibrated by the resultant of the main compressions, shown by arrows in the figure. If the position of the bend is carefully chosen, these may balance each other without causing secondary stresses of importance. It is important, however, that the curvature of the tension bars be kept to a large radius, determined by the safe bearing pressure on the concrete.* This is particularly important when the tension bars are in projecting ribs of small width, in which a heavy bearing pressure on a circular rod would exert no small splitting tendency. The bearing pressure is reduced, and the splitting tendency resisted, by providing

* See p. 77.

bars on the inside of the bend, whose ends are turned over or otherwise hooked.

If Navier's assumption of the conservation of plane sections after bending is adhered to, analysis shows that the strength of sharp bends may be very small, and even zero.*

Experience shows, however, that though a reduction of strength may occur, it is not so serious as would be indicated by analysis following Navier's theorem, and there is no doubt that at sharp bends this theorem does not hold.

It is certain, however, that a sharp bend is to be avoided, and a haunch provided wherever possible.

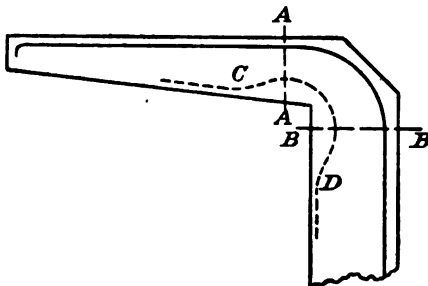

FIG. 105.—Pressure curve for sharp bend on compression side.

occurs on the compression side, it is probable that the pressure curves follow a curve round the kink, as shown in Fig. 105.

That this will reduce the strength may be gathered from the reduced depth across planes AA and BB, and this should be allowed

for. This curvature cannot take place without curvature of opposite sign at points C and D, which requires the provision of stirrups at these places. It may be taken as a general rule that, in the vicinity of bends in beams, a generous provision of stirrups will reduce the danger in a place of some weakness.

LINTELS.

Lintels in a wall are a special case of a rectangular beam, and present no difficulty when the bending moment has been determined. In the calculation of a bending moment it is usual to allow for a weight of wall bounded by two lines at 60° to the horizontal, as shown in Fig. 106, the wall outside such lines being considered capable of supporting

* See H. Kempton Dyson's paper in the *Concrete Institute Proceedings*, vol. ii. part 2, p. 157.

itself by arching action. If W is the weight of this triangular piece of wall, and l the span of the lintel, as indicated in Fig. 106, the bending moment may be taken as $\frac{Wl}{6}$. The bending moment

due to the dead weight of the lintel should of course be added to this. Where a lintel occurs close to the end of a wall, particularly if the height of the opening under the lintel is large, as in Fig. 107, the wall may not be capable of resisting the arching action, which is necessary to hold up all the brickwork above the dotted line at 60° , and hence, for such an end lintel it may be desirable to allow for a greater bending moment and shear. Where the lintels are made in moulds, and subsequently placed in position, it is necessary to take

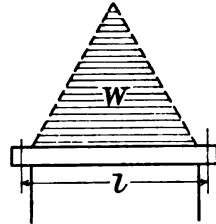

FIG. 106.—Lintel in wall.

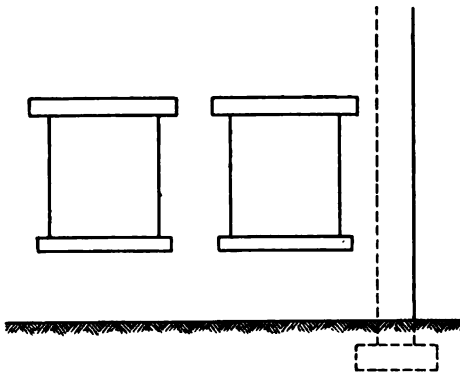

FIG. 107.—Lintel near edge of wall.

particular care that they are placed the right way up, since, as they will generally have the reinforcement at one side only, they would have little or no strength if accidentally placed upside down in the wall.

CHAPTER IX

SLABS

A CONCRETE slab forming the floor of a building is a special case of a rectangular beam of great width.

BENDING MOMENTS.

The bending moment may be determined, as for a continuous beam, by the principles of Chapter VIII., and the stresses calculated by the methods of Chapter II. The following points should, however, be noticed.

(1) In the determination of the maximum positive bending moment near midspan in a beam, in bay 2 (Fig. 108), it was assumed that the adjacent spans, 1 and 3, were unloaded, since

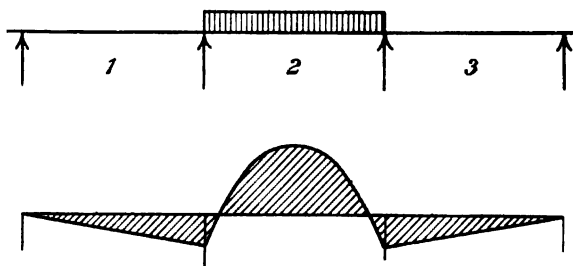

FIG. 108.—Bending moment curve for three spans, centre bay loaded.

this condition of loading gives the greatest bending moment in bay 2.

It was, however, also assumed that the upper face of beams 1 and 3 had sufficient steel to enable them to carry whatever negative bending moment might be imposed upon them under

this condition of loading, and in the case of a beam there is no difficulty in providing such steel. In the case of slabs, however, it is much more difficult, since the top bars interfere considerably with the concreting, and are very liable to get trodden down unless very special precautions are taken. It is, therefore, an almost universal practice to confine the top steel to the immediate vicinity of the support.

When this is done the maximum bending moment at the centre of a bay must not be calculated from Figs. 84, 85, and 86 in Chapter VIII., since the adjacent spans are not capable of carrying the negative moments assumed in them in the derivation of the values from which the curves were drawn, and the bending moment at midspan will therefore be a larger proportion of wl^2 than for a beam having sufficient top steel. This is the more important for slabs, as the ratio of dead to live load is less than for the beams supporting the slab, and of course the effect of dead load is to reduce these negative moments near midspan.

Generally top steel is provided to a point distant from the support some definite percentage of the span, generally about $\frac{1}{4}$ th or $\frac{1}{3}$ th, and it is possible to calculate to what extent a negative moment at the support may be assumed under unfavourable conditions of loading for various ratios of dead to total load.

Great simplification results by considering a portion of a slab of an infinite number of spans, as in Fig. 109 (a). The worst case arises when the bays are alternately loaded. Under such conditions the bending moment curve can be drawn to any convenient scale as in Fig. 109 (b), the only uncertainty relating to the determination of the position of the axis AA separating the positive from the negative moments. From considerations of symmetry this must be a horizontal line, in the particular case assumed. In a beam capable of resisting any moments to which it could be subjected, its position would be determined by considerations of elasticity as previously outlined in Chapter VIII., and it might be represented on Fig. 109 (b) by the line AA, which for usual ratios of dead to total load would involve negative moments in the unloaded bays as shown.

Since, however, the negative moment of resistance of one slab becomes zero at the point X, the slab will yield at the point X, and so relieve itself of its negative moment at this point. The effect is to cause the axis of zero moments to fall to such an extent as to indicate no moment at the point X, as shown by the line BB in Fig. 109 (c). The amount of the restraining

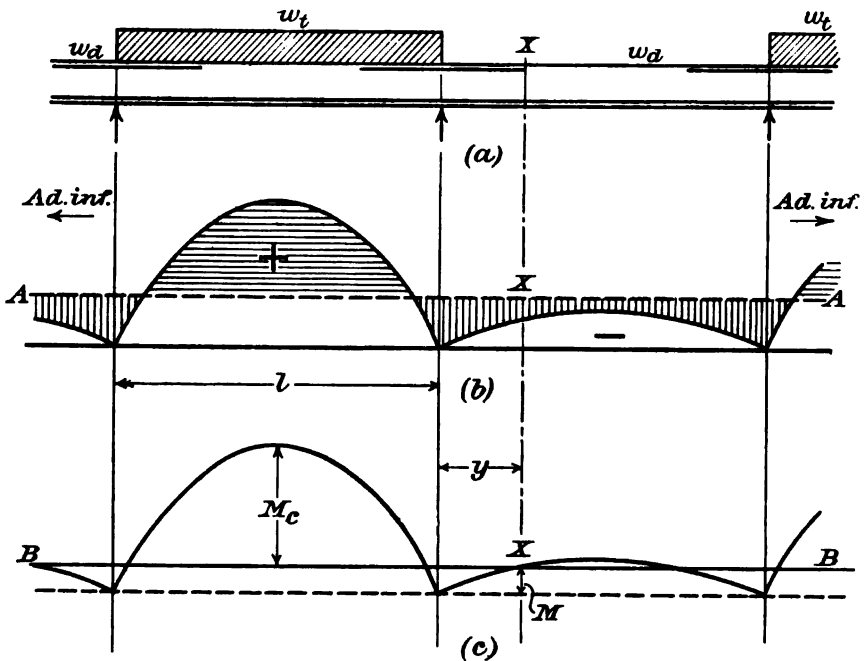

FIG. 109.—Bending moments on slabs.

moment is thus limited to the quantity M in the Fig. 109 (c), which may be easily calculated as follows:—

Let us assume the point X (the limit of the top steel) to be at a distance y from the support. Since there is no moment at the point of contra-flexure, the beam is equivalent to a freely supported beam having a span of $l - 2y$, supported by two cantilevers of length y .

Now, the reaction of the centre beam on the ends of the cantilevers is $R = \frac{w_d}{2} \cdot (l - 2y)$.

Hence the moment in the cantilever, due to the reaction R at a radius y ,

$$= Ry = \frac{w_d y}{2}(l - 2y),$$

and due to distributed dead load of cantilever,

$$= \frac{w_d y^2}{2}$$

$$\therefore M = \frac{w_d y}{2}(l - 2y) + \frac{w_d y^2}{2}$$

$$= \frac{w_d y}{2}(l - y).$$

Hence the moment to be allowed for in the centre of the loaded bay is

$$M_c = \frac{w_t l^2}{8} - \frac{w_d y}{2}(l - y)$$

$$= w_t l^2 \left\{ \frac{1}{8} - \frac{1}{2} \cdot \frac{w_d}{w_t} \cdot \frac{y}{l} \left(1 - \frac{y}{l} \right) \right\}$$

Example.—

$$\frac{y}{l} = \frac{1}{4}, \quad \frac{w_t}{w_d} = 3$$

$$M_c = w_t l^2 \left\{ \frac{1}{8} - \frac{1}{2} \cdot \frac{1}{3} \cdot \frac{1}{4} \left(1 - \frac{1}{4} \right) \right\} = \frac{3}{8} w_t l^2.$$

Similarly the moment may be calculated for other ratios of $\frac{w_t}{w_d}$ and $\frac{y}{l}$, and some such values are given in the following table:—

TABLE I.—POSITIVE MOMENTS IN SLABS.

$\frac{w_t}{w_d}$	$\frac{y}{l} = \frac{1}{4}$		$\frac{y}{l} = \frac{1}{5}$	
	Interior spans. $w_t l^2$	End spans. $w_t l^2$	Interior spans. $w_t l^2$	End spans. $w_t l^2$
1	$(0.0818 = \frac{1}{82})$	$0.0781 = \frac{1}{12.8}$	$0.045 = \frac{1}{22.2}$	$0.085 = \frac{1}{11.75}$
2	$0.0781 = \frac{1}{12.8}$	$0.1015 = \frac{1}{9.84}$	$0.085 = \frac{1}{11.75}$	$0.105 = \frac{1}{9.52}$
8	$0.0987 = \frac{1}{10.7}$	$0.1093 = \frac{1}{9.15}$	$0.0983 = \frac{1}{10.15}$	$0.1116 = \frac{1}{8.95}$
4	$0.1016 = \frac{1}{9.85}$	$0.1183 = \frac{1}{8.43}$	$0.105 = \frac{1}{9.52}$	$0.115 = \frac{1}{8.7}$

The figures for end spans have been obtained by assuming the same restraining moment at one end as for the interior beams, and of course, none at the other. The moments are then approximately the mean between $\frac{wl^2}{8}$ and that given for interior bays. Thus the values in column (2) are the arithmetical mean between 0.125 and the values in column (1), which is quite accurate enough for practical requirements.*

The figures marked in brackets are not to be used, since in this case the moments are less than those found by the usual considerations of elasticity, and the treatment given above does not apply. For usual ratios of $\frac{w_t}{w_d}$ the figures given in the table are, however, considerably greater than those derived from considerations of elasticity, and should certainly be adopted for those types of construction illustrated in Figs. 110 (a) and (b).

In those constructions illustrated by Figs. 110 (c) and (d), a certain amount of restraint may be afforded by the resistance of the beams to torsion. The calculations of this restraint involve the solution of a differential equation of considerable complexity. Since, also, the elastic properties of concrete beams in torsion are very imperfectly known, an engineer will be wise to leave this out of consideration, although a few specialists have sufficient information gathered from experience and tests to guide them. It is obvious that such restraint would vary with the size and shape of the beam, the arrangement of the reinforcement, the span and method of fixing, and is, in fact, not susceptible of mathematical treatment for any practical purpose.

It is important to notice that, although the restraining moment at the support is much reduced by the want of top steel, in the condition of loading taken above the section at the support should be capable of carrying the usual negative moment, since this will still be obtained when two adjacent panels are loaded. This moment should not be taken as less than $\frac{wl^2}{12}$, and has higher values when $\frac{w_t}{w_d}$ is considerably above

1. It may be calculated in any case by Figs. 84 to 86.

* This gives *exactly* the moment at midspan of the end bays, but midspan is not the point of maximum moment.

In connection with the question of torsion in a concrete beam as in Fig. 110 (*d*), it is to be noticed that the stirrup marked S would be put into tension by the torsion produced by loading the span shown, the adjacent ones being unloaded; this tension is in addition to that produced by the usual shearing stresses.

In the absence of sufficient provision of such stirrups, a slab subjected to very unequal loading—the deck of a bridge

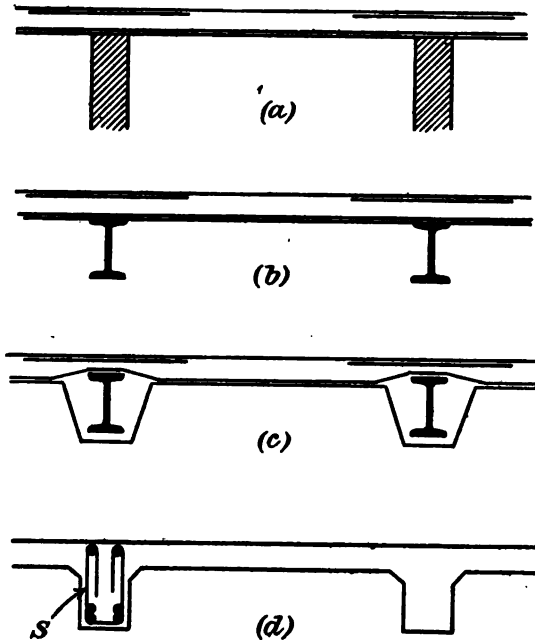

FIG. 110.—Typical slab reinforcement.

carrying heavy point loads, for instance—would tend to crack away from the beam, this cracking growing progressively under different conditions, and very much weakening the beam as regards resistance to shear.

DEFLECTION OF BEAMS AS AFFECTING SLABS.

The formulæ applying to continuous beams assume that no deflection of the supports takes place. Where such deflection occurs, the distribution of moments may be seriously altered.

Now, the supports to a slab are generally beams, subject to deflection, and sometimes to unequal deflection, and in the latter case the slab moments are affected.

It is desirable to consider the magnitude of this effect, although analysis shows that, in an average case, an increase in centre moment of about ten per cent. is the worst which need be anticipated.

Case (a). Reinforced Concrete Beams.—Consider, firstly, a slab supported on a series of beams. If one bay is loaded, as



FIG. 111.—Deflection of beam as affecting slabs.

in Fig. 111, the two beams supporting this bay of slab will deflect and reduce the negative moments in the slab, proportionately increasing the centre moment.

The extent of this has been calculated in general terms in Appendix I. 19, where it is shown that for certain assumptions the centre moment is given by

$$M = \frac{5}{72} w_s l^2 - \frac{w_s l^2}{36} - \frac{2EI\delta}{l^2},$$

δ being the relative deflection of the beam, I the moment of inertia of unit width of slab, and l the span of the slab.

Let us now consider an example frequently met in practice—beams 21 ft. span, 7 ft. apart; live load, 200 lbs./ft.²; dead load, 80 lbs./ft.²

A deflection of the beam of $\frac{1}{8}$ in. would be $\frac{l}{1016}$, and therefore a high value for continuous reinforced concrete beams under one-half working loads. A common value of EI per foot width of a slab suitable for this design would be $30,000,000 \times 1.5 = 45,000,000$ in inch and lb. units. Then, from the above formula,

$$\begin{aligned} M &= \frac{5}{72} \cdot 280 \cdot 49 \cdot 12 - \frac{80 \times 49 \times 12}{36} + \frac{90,000,000}{84 \times 84 \times 8} \\ &= 11,450 - 1300 + 1600 \\ &= 11,750 \text{ lb.-ins.} \end{aligned}$$

It will be seen that if the moment were calculated by this same formula, putting $\delta = 0$, it would equal 10,150 lb.-ins., showing that the increase in moment due to a deflection of $\frac{1}{8}$ " in the beams is about 15 per cent.

If the slab were designed with top and bottom steel—*i.e.* capable of resisting negative moments at midspan—it would be justifiable to design it by the formula in Appendix I. 10.

$$M = \frac{w_t^2}{12} \left(1 - \frac{w_d}{2w_t} \right) = \frac{w_t^2}{14} \text{ for this ratio of } \frac{w_d}{w_t}$$

$$= 11,750 \text{ lb.-ins. per foot.}$$

Hence it will be seen that the ordinary formula would in this case give as great a moment as is obtained by the consideration of deflections, and this will generally be so.

The reason for this is that this formula is based on a worse condition of loading, *i.e.* with alternate bays loaded. It should be noted that with this condition, the beams would all be deflected equally, and no increase in slab moment would result.

Case (b). Steel Joists.—Suppose, now, the beams consisted of steel joists in place of reinforced concrete, the deflection under this condition of loading would probably be double that for the continuous concrete beams. In that case the moment by the formula from Appendix I. 19 would be

$$M = 11,450 - 1300 + 3200$$

$$= 13,350 \text{ lb.-ins.}$$

It has, however, already been pointed out that slabs resting on steel joists and not provided with reinforcement top and bottom should be designed by the table on p. 191, giving a moment for this ratio of $\frac{w_t}{w_d}$,

$$M = \frac{w_t^2}{10.28}$$

$$= 13,400 \text{ lb.-ins.}$$

so that even in this case the formulæ recommended are sufficient to cover this effect in ordinary cases.

When two adjacent bays are loaded, as in Fig. 112, it will

be found that, although the deflection in the middle beam is greater, the centre moments in the slabs are much lower owing to their continuous action over this beam. It will be found on investigation that the case dealt with is the worst which needs consideration.



FIG. 112.—Deflection of beam as affecting slabs.

Case (c). Deflection of Main Beams.—There is, however, a further effect which may sometimes produce a greater relative deflection of the beams carrying the slab. This occurs when the beams are secondary beams, supported on a main beam which will itself deflect, as in Fig. 113. This phenomenon will

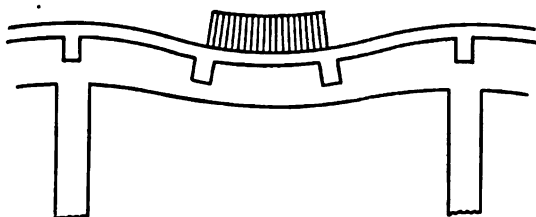

FIG. 113.—Deflection of secondary beams.

be considered by calculating what moment has to be produced in the slab to give it the same curvature as the main beam.

At midspan of secondary beams, this effect has to be added to that previously considered, due to the deflection of the secondaries themselves.

The moment in the main beam may be written $M_b = \frac{EI_b}{r}$,

and that in the slab, $M_s = \frac{EI_s}{r}$, r being the radius of curvature.

Therefore

$$\frac{M_s}{M_b} = \frac{I_s}{I_b}$$

Now, by well-known principles of applied mechanics

$$\frac{I_s}{R_s} = \frac{y_s}{f_s} \quad \text{and} \quad \frac{I_b}{R_b} = \frac{y_b}{f_b}$$

suffixes s and b denoting slab and beam respectively, and R being the resisting moment at the safe stress f .

Generally, the safe stress f will be the same for beam and slab ($f_s = f_b$).

Then
$$\frac{M_s}{M_b} = \frac{I_s}{I_b} = \frac{R_s \cdot y_s}{R_b \cdot y_b}.$$

Here y is the distance of the extreme fibre in tension or compression from the neutral axis. Which of these is considered does not, as a rule, greatly affect the result, although, of course, whichever is taken for the beam must be taken for the slab also, preferably that being considered for which the stresses f in beam and slab are more nearly equal.

Let us now apply this to a practical example, and for convenience let the same case be taken as before.

$$\begin{aligned} \text{Live load} &= 200 \text{ lbs./ft.}^2 \\ \text{Dead load (slab)} &= 80 \text{ lbs./ft.}^2 \\ \text{Span of secondary beams,} & 21 \text{ ft.} \\ \text{Span of main beams,} & 21 \text{ ft.} \\ \text{Span of slab,} & 7 \text{ ft.} \end{aligned}$$

It will be found that 20 ins. nett will be a suitable depth of main beam.

Taking 100 lbs./ft.² as the dead load inclusive of the beams, the moment for which the main beam would be calculated is—

$$M = \frac{W_t l}{9} \left(1 - \frac{W_d}{2W_t} \right) \quad (\text{see p. 168})$$

W_t and W_d being the maximum and minimum point loads at the third points due to the secondary beams. In our case

$$\begin{aligned} W_t &= 21 \times 7 \times 30 = 44,100 \text{ lbs.} \\ \text{and} \quad W_d &= 14,700 \text{ lbs.} \\ \text{whence} \quad M &= 1,030,000 \text{ lb.-ins.} \end{aligned}$$

Hence area of steel required at midspan of main beams

$$\begin{aligned} &= \frac{1,030,000}{16,000 \times 20} \\ &= 3.22 \text{ ins.}^2 \end{aligned}$$

We may now solve the formula $\frac{M_s}{M_b} = \frac{R_s \cdot y_s}{R_b \cdot y_b}$ for M_s , remembering that the moment in the main beam for the distribution of load under consideration, being that shown in Fig. 113, is much less than that for which the beam is calculated; it is—

$$M = \frac{29,400}{9} \times 21 \times 12 \left(1 - \frac{14,700}{58,800}\right) \\ = 618,000 \text{ lb.-ins.}$$

Taking for beam and slab those values of y applicable to the steel, we have—

$$y_s = 2 \text{ ins.}$$

$$y_b = 15 \text{ ins.}$$

$$\text{Hence } M_s = M_b \cdot \frac{R_s}{R_b} \cdot \frac{y_s}{y_b} \\ = 618,000 \times \frac{11,750}{1,030,000} \times \frac{2}{15} \\ = 935 \text{ lbs./ins.}^2$$

Hence the additional slab moment due to the deflection of the main beam is $\frac{935 \times 100}{11,750} = 8$ per cent.

SHEARING FORCES.

In slabs of usual proportions, in which the span exceeds ten times the depth, it will generally be found that the concrete will be capable of resisting the shearing forces without any provision being made for shear in the reinforcement.

Where this is not so, the shear should be dealt with as discussed for beams.

ADHESION.

When the shear stress on a slab is high, say above 25 lbs./ins.², it is desirable to calculate the adhesion stress and modify the design accordingly. Usually, with uniform loads, this condition does not arise.

Arrangement of Reinforcement.—It must be remembered that, however important may be the accurate determination of bending moments and shearing forces, such accuracy is useless unless coupled with a good arrangement of steelwork which,

besides satisfying every requirement as to stresses in tension, compression, shear, and adhesion, will also be capable of erection by comparatively unskilled labour, with accuracy, and at a reasonable cost.

Round bars are probably more used for slabs than any other form of reinforcement, and a good arrangement is shown in Fig. 114 (a), in which a row of straight bars alternates with a row of cranked bars. It will be seen that with this arrangement, the same area of steel is provided over the support as at midspan.

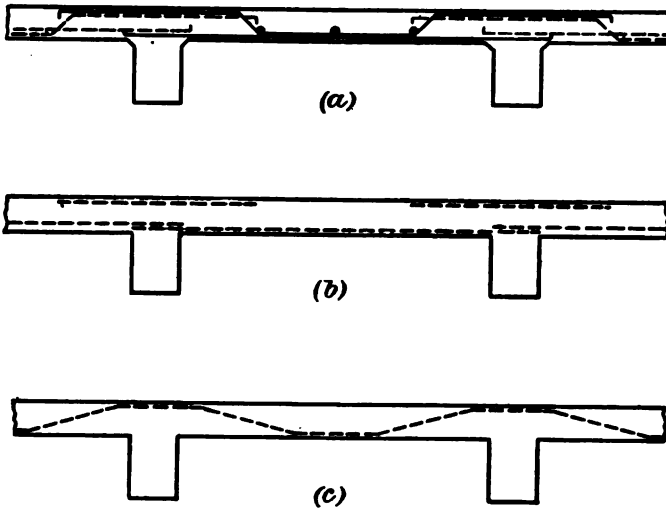

FIG. 114.—Arrangement of reinforcement in slabs.

Bars $\frac{5}{16}$ in. in diameter are frequently used in 4-in. slabs, and proportionately larger bars in thicker slabs.

In addition to the main reinforcement, some cross bars at right angles to them, as shown in Fig. 114 (a), are desirable. Their function is to prevent cracks due to contraction and changes of temperature, and to distribute a concentrated load over an increased width of slab. A 4-in. slab should not have less cross reinforcement than $\frac{5}{16}$ -in. bars at 18 in. centres. They should be near the bottom of the slab, but above the main reinforcement.

Expanded metal (see Fig. 115) does undoubtedly provide

an efficient reinforcement for slabs, and is easily fixed. The arrangement frequently adopted is shown in Fig. 114 (b), and is good. For thin slabs where only light reinforcement is required, the reduced cost of handling and fixing such a form of reinforcement may easily justify its increased first cost.

Several forms of netting, constructed from drawn wire, are also on the market. Generally the tensile strength is high in

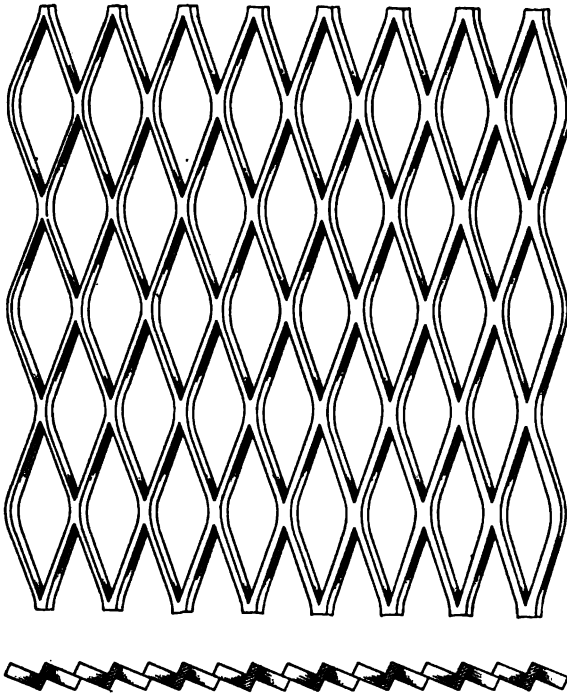

FIG. 115.—Expanded-metal reinforcement.

virtue of its having been drawn, but the bond resistance of such material is extremely low, being only one-half to one-third of ordinary steel. An attempt is made to get over this by disposing the steel as in Fig. 114 (c). This arrangement is satisfactory when adjacent bays are equally and uniformly loaded, but does not satisfy theoretical requirements in cases of unequal loading, or when heavy concentrated loads have to be carried.

PART IV

APPLICATIONS AND GENERAL NOTES

CHAPTER X

RESERVOIRS

IN any construction designed to resist water pressure without leakage occurring, special care must be taken in the proportions used in the concrete; grading the different particles is of even greater importance than for ordinary concrete. The recommendations on this point on p. 18 may be referred to with advantage. It is also desirable to increase the proportion of cement up to a certain point, but one can go too far in this direction, as a very rich concrete contracts more than a poorer concrete during setting, and is therefore more liable to the formation of contraction cracks where leakage would occur. It is also important that the thickness of walls be not made too small. Provided the stresses in the concrete, and particularly in the steel, are kept low, and the greatest precautions are taken in proportioning the concrete, a 5-in. wall is generally satisfactory for heads up to 10 feet, and an additional inch is advisable for every increase of 5 feet in the head. It is sometimes necessary, and always a good plan, to render the wall on the water side with a 1 to 1 cement mortar about $\frac{1}{2}$ in. thick. Such rendering should be applied while the concrete is green to attain the best adhesion. It sometimes happens, however, that contraction cracks are produced in the concrete several weeks after this has been placed, and for this reason it may be preferable to hold back the application of the rendering for about three weeks to ensure that such cracks will not be formed in the rendering also. Where any

difficulty is experienced in getting the rendering to adhere to the concrete, the face of the latter may be picked with a sharp-pointed tool.

The elongation to which concrete may be subjected without the formation of minute cracks is very much less than that corresponding to the usual stress in the steel, viz. 16,000 lbs./ins.², and for this reason it is advisable to limit the stress in the steel in constructions which must be water-tight, to about 10,000 lbs./ins.²

It would appear likely that bars giving an increased mechanical bond—such as the indented bar and twisted bar—would have the effect of causing this elongation in the concrete to occur gradually along the length of the bar instead of showing itself by the formation of cracks at intervals, or, at any rate, that the hair cracks should be closer and correspondingly smaller, than when smooth bars are used. To this extent, they have advantages over plain bars for constructions where water-tightness is required.

It may be pointed out that a greater allowance for continuity is generally permissible in the calculation of bending moments, since it is not generally possible to load one bay in the floor of a water-tank, for instance, without the adjacent bays being loaded to the same extent. Most of the formulæ given earlier in the book for bending moments in beams and slabs have assumed the possibility of such unequal load occurring, and will therefore give a higher bending moment at mid-span of slabs and beams than need be allowed for in the structures now under consideration. It may be said that some designers have used ordinary stresses and ordinary allowances for bending moments in the design of structures to hold water, and have obtained satisfactory results. This is, however, more by good luck than discernment, since in such cases the bending moments have been over-estimated, and the actual stresses in the structure will be found to have the low value recommended by the authors. It is important that an adequate percentage of steel be inserted in the concrete in both directions, even when the stresses due to water pressure occur in one direction only, as otherwise slight cracks may occur.

For example, in the walls of a tank, the slab might be

designed to span horizontally between vertical beams, as in Fig. 116, and in that case the main slab reinforcement would be horizontal. Owing to the restraint afforded by the base and roof, secondary moments will be caused at the junction of the slab to these, and cracks may be produced unless a sufficient amount of vertical reinforcement is provided at these points. Such cracks would not be very objectionable in ordinary structures, but would, of course, be most objectionable in reservoirs.

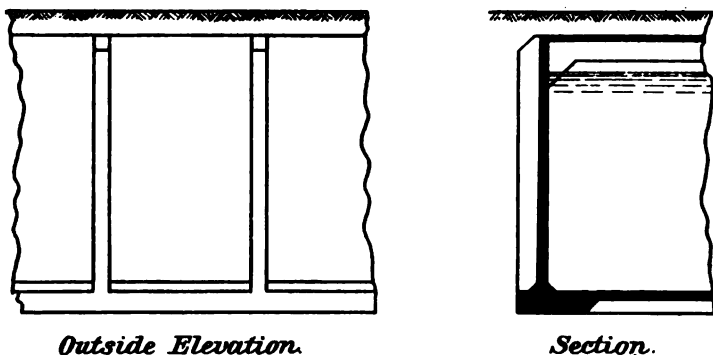

FIG. 116.—Reinforcement of slabs in the walls of tank.

Although not coming strictly under the province of design, it may not be out of place to remark here that rapid drying of the concrete, always undesirable, is particularly so for structures of the kind under consideration, as it increases very largely the chances of contraction cracks. In summer-time, for example, the concrete should be protected from the direct rays of the sun for the first three or four days after placing, and should be kept in a moist condition. It is a good plan to cover the concrete with sacking or sawdust, and to keep this watered.

Reservoirs may be either sunk below the ground or may be entirely above it. Treating the former of these types first, it will be necessary to design for two conditions—those of the reservoir full and empty.

In the first of these cases the water presses outwards, while in the other case the pressure of the surrounding soil is directed

towards the middle of the reservoir. For this reason it is generally necessary to design the walls of such a reservoir with steel on both sides, so that they may be able to resist pressure from either side.

In such cases the reversal of stress is an additional reason for the adoption of low working values.

It may be noted that circular reservoirs are excellently adapted to withstand external earth pressure owing to their circular form.

In calculating the pressure on the sides of a wall when a reservoir is full, it is sometimes permissible to make some allowance for the earth pressure on the other side, but considerable judgment is necessary in determining to what extent this is advisable in any particular case. It may, for instance, happen that under certain conditions, such as a long period of hot weather and continued absence of rain, the surrounding soil dries and contracts, and a small space is formed between the outside of the wall and the surrounding earth. Obviously, in such cases the earth pressure would not be obtained until considerable movement or deflection had occurred, by which time the reservoir would, of course, be leaking. It is generally desirable also to make the reservoir strong enough to permit excavation round it if this should be desirable. When a leak occurs in the side, for example, or when it

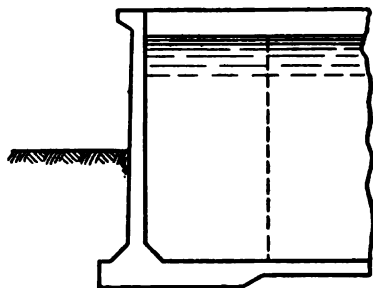

FIG. 117.—Cantilever type of wall for reservoir.

becomes necessary to connect up a new main to the reservoir, such excavation may be necessary. For this reason, careful engineers will neglect the assistance from the surrounding earth in resisting internal pressure when any uncertainty exists. When the sides of the reservoir are of the cantilever type, as shown

in Fig. 117, an important point occurs in determining the dimensions of the heel. In the case of an ordinary retaining wall the weight resisting overturning would include the

weight of earth bounded by the dotted line shown on the figure, and it would at first appear reasonable to take the corresponding weight of water into account when considering the stability of the sides of reservoirs. Where the absolute watertightness of the floor of a reservoir can be guaranteed, and the material on which the reservoir is built is porous or artificially drained, it may be permissible to take this water into account as helping to resist overturning; but it is generally difficult to guarantee the absolute watertightness of the floor, and it is obvious that if any leakage were to occur where the subsoil is badly drained, an upward pressure would be produced on the under-side of the heel, which would partly or totally neutralize the weight of water above it. It is therefore generally desirable to make the heel of sufficient thickness and width to be stable when the weight of water above it is neglected in the calculation of its stability.

As for retaining walls of this type, particular care has to be given to the arrangement of bars near the joint between the vertical face and the footing, particularly with regard to the fixing of the ends of such bars.

Frequently a reservoir has to be provided with a roof, which may be monolithic with the rest of the structure. In designing the sides of the reservoir it is then sometimes permissible to consider this roof as acting as a tie from one side to the other, and to treat the sides as spanning vertically from the floor to the roof, both floor and roof being, of course, reinforced accordingly.

When, however, the width from side to side of the reservoir is large, as is frequently the case, the elongation in such a tie may be considerable, amounting sometimes to as much as an inch; hence, for reservoirs of considerable size this form of treatment should not be adopted, as cracks might be produced before this elongation had occurred; and it is better in such cases to design the sides of the reservoir to have sufficient stability when treated as retaining walls, without taking into account the action of the roof and floor as forming a tie.

Circular Reservoirs. — Circular reservoirs are generally cheaper than rectangular ones, except when the capacity is small.

The outward pressure of the water is resisted by direct tension of the walls without any bending moments being produced. Inward pressure of the earth—where the reservoir is below ground—is resisted by a direct compression in the walls, without causing any bending moment if the pressure is balanced all round the wall. In practice it is generally desirable to give the walls a certain stiffness in case the pressures are not quite evenly distributed, when some bending may exist.

For small reservoirs of this type, the increased cost of circular centering may outweigh the reduction in the quantities. This is particularly the case when the thickness of walls approaches the practical minimum, or that required for water-tightness; in this case no reduction is effected in the quantity of concrete, the saving been confined to the steel, which, in a small reservoir, is but a small item.

Sufficient steel is to be inserted in the wall, in the shape of horizontal rings, to take up the whole tension at a small stress, if water-tightness is to be guaranteed. This tension may easily be calculated as follows:—

If d = internal diameter,

p = pressure of water at a certain depth,

then the tension in a ring of unit height, at that depth, will be

$$T = \frac{pd}{2}.$$

Thus, at a depth of 10 ft. the pressure is

$$p = 10 \times 62.4 = 624 \text{ lbs./ft.}^2$$

Hence, if we imagine a tank 32 ft. in diameter cut into rings by horizontal planes one foot apart, the tension in the ring at a depth of 10 ft. will be

$$T = \frac{624 \times 32}{2} = 10,000 \text{ lbs.}$$

At a stress of 12,000 lbs./ins.², the area of steel required in this foot would be

$$A = \frac{10,000}{12,000} = 0.833 \text{ in.}^2$$

Hence, horizontal rings of $\frac{3}{4}$ in. diameter bars at 6-in. centres would be suitable reinforcement.

An important point requiring careful treatment occurs near the base. The horizontal rings just designed are strong enough to balance the water pressure, and designers are therefore tempted to rely upon them alone, and to neglect certain secondary stresses caused by the increase in diameter of the reservoir when the pressure is applied from within. It is obvious that when this occurs—and of course the circumferential tension cannot occur without a corresponding increase in diameter—there will be a tendency to crack at the

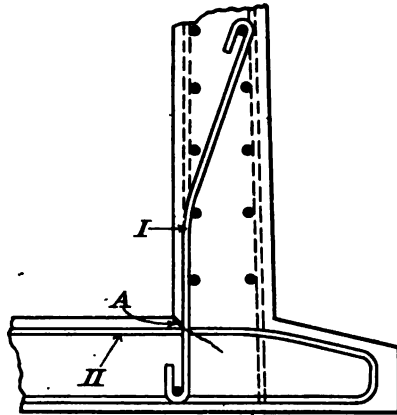

FIG. 118.—Reinforcement at base of circular reservoir.

point A (see Fig. 118) owing to the restraint afforded by the base. This restraint produces both a restraining moment, which may be resisted by bars I in Fig. 118, and also a direct tension in the base, which may be resisted by bars II.

The amount of these moments and forces it is very difficult to express in general terms, and they must eventually be left to experience with previous tanks. It is obvious, however, that the stiffer the walls and the base, the greater will be this secondary moment. It is also obvious that its magnitude depends on the nature of the soil on which the reservoir is built; where this is such that the bottom is absolutely fixed, either by cohesion to rock face, or by friction to a good solid earth, considerable restraint is offered; while on a soft plastic sub-soil, capable of a slight deformation, the base may extend somewhat under the direct tension to which it is exposed, and the restraint to the sides will thus be reduced. These are essentially matters for an experienced specialist; it is one of the evils of the system of competitive designing, still much in vogue, that the specialist will frequently take precautions

against such points, and find that he has lost the work to an inexperienced or less conscientious competitor whom ignorance drives with a light heart over dangerous places.

It was stated in the preface that practical experience is the last resort of a designer, and that the object of theoretical analysis is very largely to enable experience of previous structures

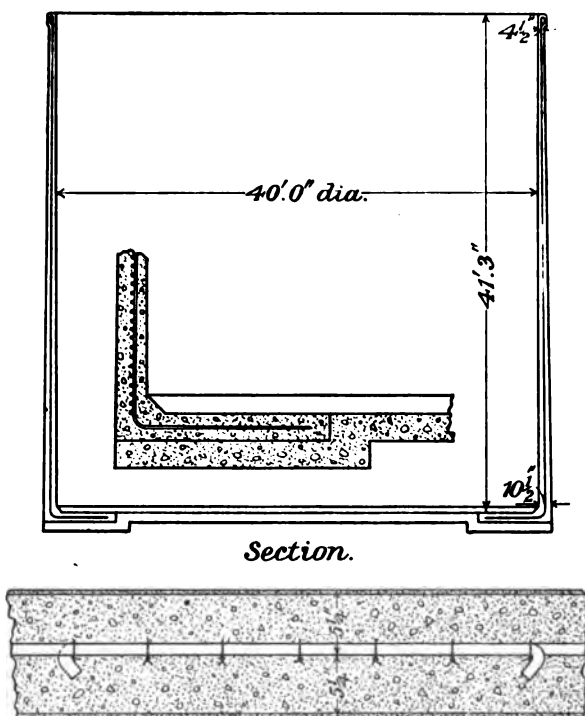

FIG. 119.—Detail of reservoir at Mittagong, N.S.W.

to be used in new ones. A failure of an actual reservoir must therefore be a fruitful source of information, and worthy of careful examination. Such a failure occurred on January 22, 1909, at Mittagong, N.S.W., the details of the reservoir being shown in Fig. 119.

The reservoir was 40 ft. in diameter, and intended to hold 40 ft. of water, though only containing 32 ft. of water when it burst.

The thickness of wall was $10\frac{1}{2}$ ins. at the base, and $4\frac{1}{2}$ ins. at the top. The circumferential bars varied from 1 in. diameter at 3 ins. pitch near the base to $\frac{1}{2}$ in. diameter at 4 ins. pitch near the top. They were arranged in a single layer near the middle of the wall. They were designed for a tensile stress not exceeding 16,000 lbs./ins.², though the actual stress was only 12,750 lbs./ins.² at floor-level under 32 ft. of water—the condition at time of fracture—and fell off rapidly higher up.

The bars were of commercial mild steel, and the joints were made by lapping about 40 diameters, and providing a hook at each end. Neglecting the hook, the adhesion developed would be 100 lbs./ins.² under the head of 40 ft. as designed, and 80 lbs./ins.² at floor-level under 32 ft. of water, falling off rapidly, however, towards the top under the latter condition.

A paper presented to the Institution of Civil Engineers by E. M. de Burgh, M.I.C.E. (vol. clxxx.), would indicate that the materials and workmanship were good. The reservoir had been completed ninety-eight days when failure occurred, the lower portions being considerably older.

Referring to the design, 16,000 lbs./ins.² may be dangerous as regards water-tightness, but should be quite safe as regards stability. The actual tensile stress of 12,750 at the time of failure cannot be regarded as excessive or to account for failure at all.

Coming to the question of adhesion, the authors have given it as their opinion (see p. 74) that 100 lbs./ins.² is too high a value under good conditions. They have also pointed out that the adhesion depends very greatly on the wetness of the concrete, being greatly inferior in dry concretes owing to their contracting so much less while setting.

There would appear to be no doubt that in the present instance the concrete was mixed very dry, and with the arrangement of steelwork adopted, in which 1-in. bars are spaced at 3-in. centres, the adhesion—which depends upon the tension in the concrete round the joint—may well have been further reduced by a plane of weakness through the centre of the rings, due to the difficulty of ramming the concrete at this point. It is extremely probable, then, that failure was due to slipping at the joints, caused on the one hand by too small a lap length,

but much more so by the concrete being placed too dry, which in the present instance was particularly detrimental to the strength of the joints owing to the disposition of the bars.

The examination of the pieces of wall after the bursting strongly supports this view, as pieces of concrete of considerable area were found having a thickness of half the reservoir wall, showing that the concrete had failed in the vertical plane of the rings. The fact that hardly any of the bars had any concrete adhering to them is also strong evidence in support of the above opinion.

The walls of reservoirs rectangular in plan are frequently designed to span vertically between the roof and the floor, whether they do so as simple slabs, for small heights, or as beams between which the slab spans horizontally.

In either case, the bending moments produced are not determined by the formulæ already given in Chaps. VIII. and IX., since the load produced by the water pressure, instead of being uniform, now varies from zero at water-level to a maximum of

$$w = \delta l$$

at the base, w being the pressure per unit area, δ the weight of water per unit volume, and l the height of water and the span of the beam.

In units of pounds and feet, δ for fresh water is 62.4 lbs./ft.³

It is shown in Appendix I. 18, that when no fixity is allowed for at the ends, the moment curve will be as in Fig. 120, the maximum value occurring at a point 0.577 l from the top, and having a value of

$$M = \frac{wl^2}{15.5}$$

w being the *maximum* pressure near the base.

In an actual reservoir beam, as sketched in the figure referred to, it generally happens that no fixity is afforded by the ends. Although continuous with the roof beam, the tendency of the roof beam is to deflect downwards, and that of the wall beam to deflect outwards, and whether the continuity of the roof beam restrains the wall beam, or constrains it to deflect

outwards will depend entirely on the relative stiffnesses and spans of the two. Obviously if the roof beam were long and slender and the wall beam short and stiff, the effect of its continuity with the roof beam would be to increase rather than to decrease its moments near midspan.

Similarly at the base, it frequently happens that the reinforcement is very light, and is designed for taking up direct tension alone. In such cases it is generally quite incapable of supplying the negative moment required to fix the end of

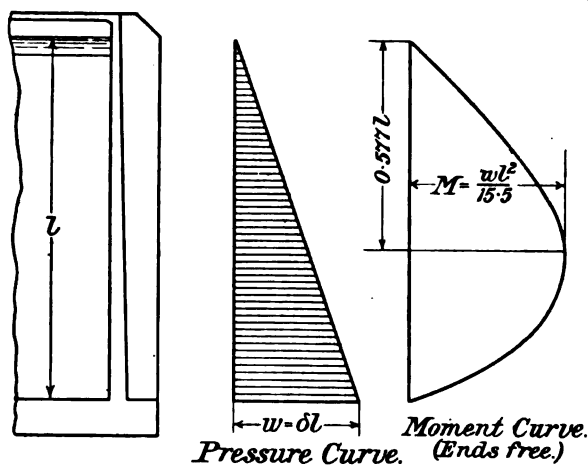

FIG. 120.—Vertical beam of rectangular reservoir.

the wall beams, which is particularly the case if the reinforcement follows the lower rather than the upper surface of the floor. Hence in general, a central moment of

$$M = \frac{wl^2}{15.5}$$

should be provided for.

Where in special cases it is considered justifiable to allow for some continuity, it is shown in Appendix I. 18, that when the lower end may be considered absolutely fixed and the upper end free, the central moment is

$$M_c = \frac{wl^2}{33.6}$$

and the moment at the lower end is

$$M = -\frac{wl^2}{15}.$$

If the upper end alone is fixed, and that absolutely, the central moment is

$$M_c = \frac{wl^2}{23.6}$$

and the moment at the upper end is

$$M = -\frac{wl^2}{17.1}.$$

It will be seen from this that where considerable doubt exists as to the degree of fixity which will be afforded, it will always be safe to design the ends and the centre for

$$M = \frac{wl^2}{15}.$$

The notes about bent beams (see p. 184) apply to the top and bottom joints of the beams under consideration.

Water Towers.—Water towers constitute a special case of reservoirs, elevated above ground-level and supported by walls or columns. The considerations applying to the design of reservoirs will therefore mostly be applicable to the tank itself, and it remains to mention a few considerations affecting the design of the supporting tower.

In designing foundations for a water tower it is desirable to put much lower stresses on the soil than for ordinary buildings, since, on the one hand, the footing of a water tower generally receives the load for which it is designed, while those of an ordinary building very frequently do not, and on the other hand, whereas a slight settlement in an ordinary building, though objectionable, is generally limited to the formation of a few cracks without greatly impairing the carrying capacity of the building, in the case of a water tower such a settlement would cause the tank to leak, and to be unfit for the work for which it is designed. It is important that the wind pressure be taken into account in calculating the load on the footings,

since, in water towers where the ratio of the height to the width of the base is considerable, the increase in average pressure due to the wind may amount to 100 per cent. In addition to this increase in the average pressure, a bending moment is also produced in the columns of water towers relying entirely on horizontal braces, and in such cases the eccentricity of the load will still further increase the maximum stress on the foundation (see p. 217). It is also necessary to consider the stability of the tower as a whole against overturning, and in calculations for this purpose the tower is of course to be considered as empty, since this is the most dangerous condition which occurs.

In the design of foundations for water towers the use of concrete piles has many advantages, since the carrying capacity without any settlement may be determined with certainty from the behaviour of the pile during driving, and in the case of those water towers whose height is large in comparison to the width of the base, an additional factor of safety against overturning will be provided by the tensile strength of the piles on the windward side when the columns above them are well bonded to the steel in the pile. This may be done by cutting away 3 or 4 ft. of concrete from the top of the pile after driving, and thus exposing the bars, which may be lapped with the column bars, and concreted up again. It is, however, very desirable that the width of base should be made great enough to avoid tension in the columns on the windward side, under any conditions, since some uncertainty exists as to the effect of reversal of stress in a reinforced concrete member.

Efficient bracing between the columns is essential, and such bracing may be either diagonal, as shown in Fig. 121 (a), or may consist solely of horizontal braces, as in Fig. 121 (b).

It is to be noticed that the stresses in braces are subjected to complete reversal, and should be kept at a low value accordingly, in accordance with the notes on p. 22.

There is no particular difficulty in the design of diagonal braces, which will follow the method in steelwork design for the solution of a similar problem; nor in the design of the columns when this type of bracing is used, which will be subjected to a direct load due to the weight of the tower and increased by a

certain percentage by the wind. In the case of the method of bracing shown in Fig. 121 (b) the problem is much more

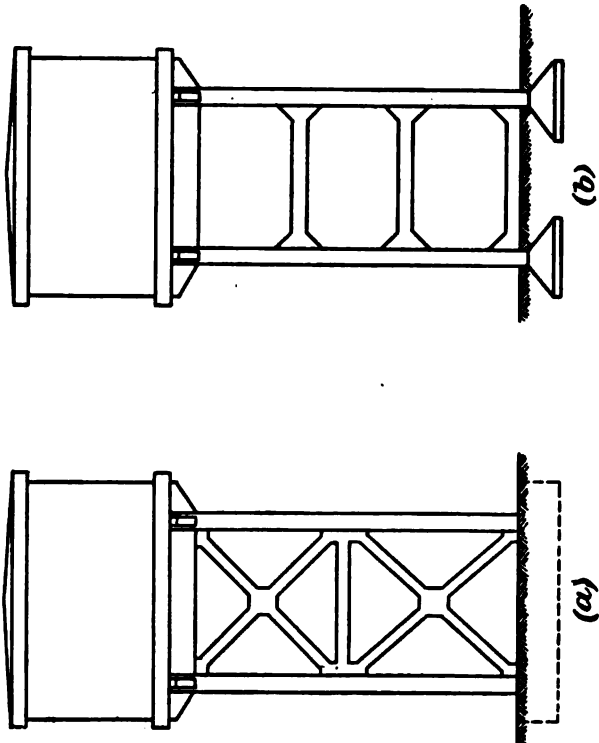
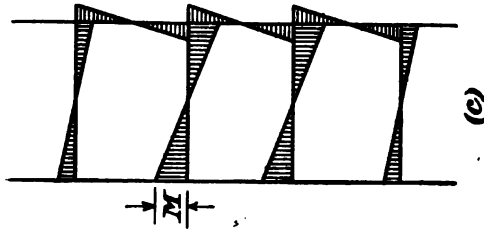

FIG. 121.—Bracing of columns of water tower.

complicated, since the efficiency of this bracing depends entirely on the moment of resistance of the brace, particularly

near the joint, and the bending moment produced in the brace by the action of the wind has to be taken up by the columns, so that it considerably affects the size of the latter. The exact calculation of the bending moment produced in the braces and columns is frequently a very complicated matter. The bending-moment curve will, however, be of the form shown in Fig. 121 (c).

It may be noticed that the bending moment is zero at the mid span of the brace, varying gradually from a positive value at one end to a negative value at the other. Since the moment is a maximum at the ends, it is particularly desirable that the braces should be well haunched to the columns, not only to increase their moment of resistance at this point, but also to enable the necessary bond strength in the brace bars to be obtained, which is generally impossible in the width of the column itself. These heavy bond stresses occur in the column bars also, owing to the reversal of moment which occurs in a length of column equal to the depth of the brace. A large haunch has the effect of largely increasing this length, and reducing the bond stresses in the column bars proportionately.

If the maximum value of the moment in the brace be denoted by M , then the maximum moment produced in the column, except at the extreme ends, will be approximately $\frac{M}{2}$. The bending moment in the column varies from positive value at one brace level to a negative value at the next, and there changes in sign abruptly, as indicated in the figure. When the column has an equal moment of inertia throughout, and the braces and their joints have equal length and stiffness, it is sufficiently accurate for practical purposes to take the sum of the moments M in the braces as equating the total overturning moment on the tower.* For example, suppose a tower is braced at four levels, as in Fig. 122, and exposes a surface of $30' \times 20' = 600$ sq. ft. to the wind at a

* This rule is given here by the authors for the first time. It is, as stated, only approximately true, being a greatly simplified form of a more general expression taking the stiffnesses of columns and braces into account, but may well be used in default of a better rule.

mean distance above the foundations of 70 ft.; the total overturning moment, due to the wind, would be

$$M = 600 \times 50 * \times 70 \times 12 = 25,200,000 \text{ lb.-ins.}$$

Supposing the tower to have four columns; there would be eight effective joints in the bracing in each of the two tiers,

that is, sixteen † joints in all, and consequently the moment for which the brace should be designed may, according to the rule given above, be taken as

$$\frac{25,200,000}{16} = 1,580,000 \text{ lb.-ins.}$$

and the brace should be designed to resist this moment. In the design of the columns it is necessary to provide for a bending moment of

$$\frac{1,580,000}{2} = 780,000 \text{ lb.-ins.}$$

It will be found that this moment increases the necessary size of the columns considerably if the same stresses are to be worked to; thus, in the example given, if the weight of the tower full of water were 2,000,000 lbs., the load per column would be 500,000 lbs., and for a stress of 500 lbs./ins.² a

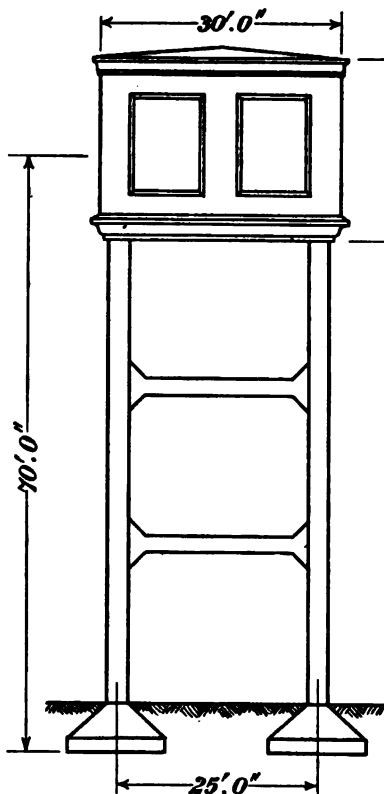

FIG. 122.—Example of bracing of water tower.

* Taking 50 lbs./ft.² as the maximum wind pressure. This is no doubt a full allowance, but in the example the area of columns and braces has been neglected.

† In the case of the upper and lower joints, the moment in the braces are equal to those in the columns, and these braces are therefore not so effective. To allow for this, it would, perhaps, have been better to allow for twelve joints instead of sixteen.

suitable design, neglecting bending moments, would be a column 30" × 30" with 1 per cent. of steel. The increased stress in the column, due to a B.M. of 790,000 lb.-ins., would be approximately 500 lbs./ins.² making a total stress of approximately 1000 lbs./ins.² To bring this stress down to a value consistent with ordinary practice it will obviously be necessary to increase the dimensions of the column, or largely to increase the amount of steel in it.

Coming now to the design of the foundations, let us suppose that an isolated footing 12 ft. square is provided under each column. With no wind, the pressure on the soil would be that due to the weight alone—

$$p = \frac{500,000}{144} = 3470 \text{ lbs./ft.}^2$$

Considering now the effect of wind pressure on the foundations, the pressure on the tower as a whole causes an eccentricity of the weight on the base of

$$e = \frac{M}{W} = \frac{25,200,000}{2,000,000} = 12.6 \text{ ins.}$$

If the columns are 25 ft. apart at the base, the increase in average pressure under the leeward footings would be

$$\frac{2 \times 12.6}{25 \times 12} = 0.083,$$

whence $p = 3470 \times 1.083 = 3760$.

In this example the increase is very small.

In the design of the bracing, it has, however, been assumed that the footings are stiff enough to exert the same moment in the columns as a brace at ground-level. Consequently the effect on the ground pressure of a moment of 790,000 lb.-ins. on each footing must be considered. This moment causes an eccentricity of

$$e = \frac{790,000}{500,000} = 1.58 \text{ ins.}$$

Hence the maximum pressure under foundations would be

$$\begin{aligned} p &= 3760 \left(1 + \frac{6 \times 1.58}{12 \times 12} \right) \\ &= 4000 \text{ lbs./ft.}^2 \end{aligned}$$

The increase in pressure due to the wind is therefore from 3470 to 4000. It should be noted that the example taken is one in which this increase will be considerably below the average, since the tower is of a great capacity. For smaller towers the ratio of wind pressure to weight is much greater, and the effect of wind on columns and foundations is greater in proportion.

The example serves, however, to illustrate the technical points involved.

The distance apart of the braces is to be determined primarily by the consideration that the ratio of unsupported length of column to its diameter should not be so great that buckling is at all likely to occur. It is, however, frequently desirable to have the distance between the braces less than is given by this consideration.

CHAPTER XI

RETAINING WALLS

ANY loose material, such as earth, is able to stand up at a certain slope, the angle of slope depending on the properties of the material, and chiefly upon the coefficient of friction of the particles on one another. In addition to this friction most earths have the property of cohesion, which enables them to stand up at a greater slope.* Under changing atmospheric conditions, and especially due to the effect of water, this cohesion may be entirely, or almost entirely, lost. Consequently Rankine, when investigating the subject of earth pressures, neglected cohesion, and based his rules entirely on the friction between the particles. He also neglected the friction of the earth on the back of the retaining wall when the top of the filling is horizontal.

When it is required to make the earth stand up at a slope greater than the natural slope at which the material will stand under normal atmospheric conditions, it becomes necessary to build a retaining wall in front of it, and the pressure exerted on the back of such a retaining wall will depend on the difference of slope between the face of the wall and the natural slope of the material. For a vertical wall holding up a bank of earth, the top of which is horizontal, Rankine found that the pressure at any depth could be expressed by the formula

* The subject of cohesion, and, indeed, of the behaviour of earths under various conditions, is a very large one, and one on which considerable lack of information still exists. Some soils, such as clean sand, will stand up at a greater slope when moist than when quite dry. When, however, the quantity of moisture increases beyond a certain point, the cohesion is lost, and the angle of slope may fall to practically zero.

On the subject of cohesion, Prelini's book on "Earth Slopes and Retaining Walls" may be referred to.

$$p = wh \left(\frac{1 - \sin \theta}{1 + \sin \theta} \right)$$

under the assumptions mentioned above, where θ is the angle whose tangent is the coefficient of friction of the material. When the upper surface of the earth, instead of being horizontal, is surcharged, its slope being δ as in Fig. 123, the formula is

$$p = wh \cos \delta \frac{\cos \delta - \sqrt{\cos^2 \delta - \cos^2 \theta}}{\cos \delta + \sqrt{\cos^2 \delta - \cos^2 \theta}}$$

When the fill behind a retaining wall has a superload, an increased pressure will be exerted on the face of the wall. This increase is constant for the whole depth, and has a value

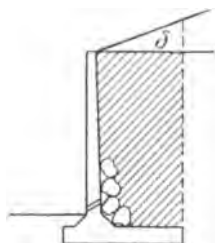

FIG. 123.—Retaining wall, with surcharge.

$$p = w \frac{1 - \sin \theta}{1 + \sin \theta}$$

and its resultant acts at a height of $\frac{h}{2}$ above the base of the wall, w being the superload per unit area.

Many other formulæ have been suggested for the pressure on the face of a retaining wall,* by taking into account, for example, the friction between the earth and the back face of the wall. It is better, however, to base actual constructions on the results of experience† rather than on theoretical calculations involving the coefficient of friction, which generally

* It is generally accepted as a fact, that the pressure exerted by earth on timber shoring in cuttings is frequently greater near the top than the bottom of the trench. This was brought out, for example, in Mr. J. C. Meem's paper on "Bracings of Trenches and Tunnels" before the American Society of Civil Engineers in August, 1907. It may be thought that this fact is in direct opposition to the results of Rankine's formulæ. This, however, is not so, since the conditions are very different. The distribution of pressure exerted on the shoring of a trench may be very similar to that on a retaining wall immediately after the earth has been filled; but in a retaining wall, the full pressure may not be exerted until after the lapse of several months. Many examples could be quoted to prove this.

† For data on the behaviour of several retaining walls, the "Interim Report on Retaining Walls," by the Committee on Masonry of the American Railway Engineers and Maintenance of Way Association, February, 1909, may be studied.

varies considerably under different conditions of moisture, and for this reason Rankine's formula is recommended, with the proviso, however, that the value of θ be taken, not from experiments on the natural slope of the material, but, where this is possible, from the proportions of retaining walls which have been satisfactory. The following table gives expressions for θ , $\sin \theta$, and for the quantity $\frac{1 - \sin \theta}{1 + \sin \theta}$, which experience shows it is safe to use for retaining walls.

Average values of the weight per cubic foot are also given.

	θ	$\sin \theta$	$\frac{1 - \sin \theta}{1 + \sin \theta}$	w lbs./ft. ³	$\frac{w}{2} \left(\frac{1 - \sin \theta}{1 + \sin \theta} \right)$
Clay	80	0.5	0.383	120	20
Coal	40	0.643	0.217	58	5.8
Earth	35	0.574	0.271	80-120	10.8-16.2
Sand (dry) ...	30	0.5	0.383	90	15
" (moist) ...	35	0.574	0.271	110	15
" (wet) ...	25	0.423	0.406	125	25.4
Shingle	40	0.643	0.217	88-100	9.6-10.8
Stone (broken) ...	40	0.643	0.217	88-100	9.6-10.8

The substitution of any of these values in Rankine's formula will give the pressure per square foot at any depth. If the total height of the retaining wall is h , it will be seen that where the top of the earth is horizontal the total pressure may be given by the formula

$$P = \frac{wh^2}{2} \left(\frac{1 - \sin \theta}{1 + \sin \theta} \right)$$

w being the weight of the material per cubic foot, and the resultant of this pressure acts at a height of $\frac{h}{3}$ above the base.

This pressure P is obtained conveniently by multiplying the value in the last column by h^2 .

In connection with the question of earth pressure, it is important to notice that it depends very much on the amount of moisture present, and may reach extremely high values in water-logged soil. For this reason it is extremely important to see that the face of a retaining wall is provided with weep holes at frequent intervals, of sufficient size not to get choked

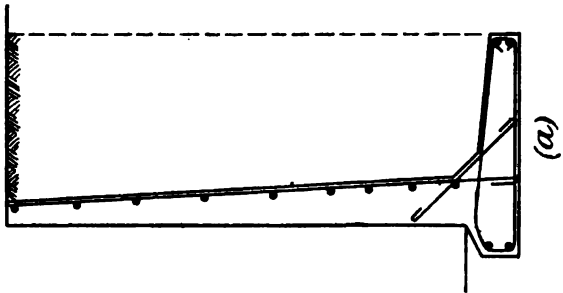
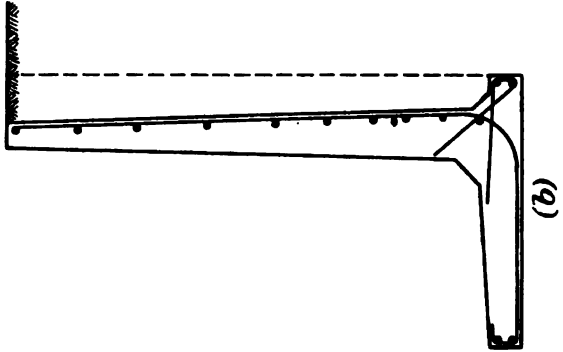
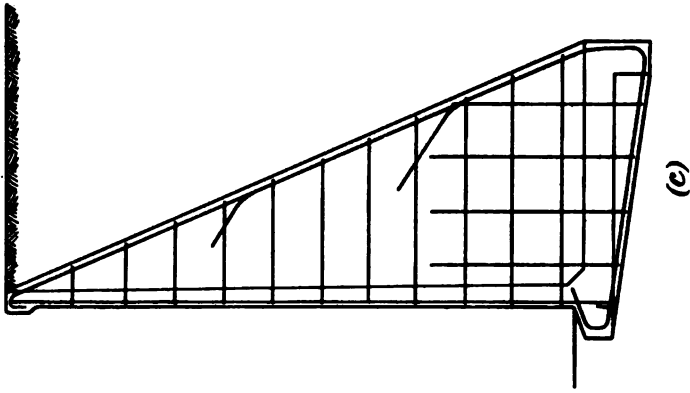

FIG. 124.—Types of retaining walls.

up, and that large boulders, or masses of loose bricks, are piled immediately behind the retaining wall to ensure good drainage, as shown in Fig. 123.

Different Types of Retaining Walls.—Fig. 124 shows several types of retaining walls, which are frequently adopted in practice. Types (a) and (b) are referred to as cantilever walls, because the front slab owes its stability entirely to its strength as a cantilever about the base.

In the type (c), however, triangular buttresses are provided at intervals, and the front slab spans between these. This type is therefore referred to as a buttress or counter-fort retaining wall.

Nomenclature.—To avoid confusion when referring to the different parts of a retaining wall, it is useful to adopt some convention which may be used consistently throughout. Such a convention is suggested in Fig. 125, where the retaining wall is likened to a man looking away from the bank of earth to be retained, and the different parts of a retaining wall are referred to as the toe, heel, front, and back, accordingly. It will be seen that types (a) and (b), referring back to Fig. 124, differ only as regards the proportion between the toe and the heel. This difference is, however, important, since it affects very largely the proportions of the wall necessary to secure stability. It will be seen that to overturn type (a) it is necessary to lift the mass of earth

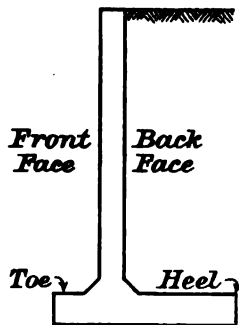

FIG. 125.—Terms used for retaining wall.

up to the dotted line, while to overturn type (b) only the weight of the vertical wall and the small amount of earth immediately above the heel has to be lifted. For this reason it will be found that for a given factor of safety as regards overturning, the ratio of base to height need be much smaller in type (a) than in type (b). This ratio frequently has values of 0.4 to 0.5 for type (a), and 0.5 to 0.7 for type (b). On this account type (a) may lead to a more economical design as regards the quantity of steel and concrete required. When, however, it is necessary to excavate the earth shown hatched on the figure, in order to construct the walls, it will be seen

that this is very much greater in type (a), and for this reason it may really be less economical when this is taken into account. Again, when the retaining wall serves to hold up earth round a basement, and it is desired to obtain the largest possible area, without any portion of the wall projecting outside one's property, it may be seen that type (b) may be much more suitable, even though its initial cost be somewhat higher. It may be noted that in general type (b) involves less stress in the foundation than type (a).

The cantilever type of wall is generally adopted for heights up to about 18 ft., while for greater heights the buttress type is cheaper, and may be adopted when the buttresses are not objectionable, as they would be, for instance, if they projected into a basement which was to be used. The best proportions for a wall depend very largely, not only on the material to be retained, but also on the nature of the soil on which the wall is founded. Overturning will usually not occur until the safe pressure has been exceeded on the earth immediately below the front edge of the toe.

An interesting point occurs in connection with the factor of safety of retaining walls. If the usual stresses in the steel and concrete are not exceeded, the structure will have a real factor of safety against fracture of somewhere between two and three, which is loosely expressed by saying that the wall has this factor of safety. It is, however, very important to realize that the overturning moment on the wall cannot be increased to this extent, as the wall would overturn long ere this happened. In fact, although the factor of safety in the materials is two to three, the factor of safety against overturning is not much above one. This is important when considering the safety of surcharging an old wall, and equally important when deciding upon the pressures to be allowed on the back of the wall; if the latter are underestimated, the result may not be confined to raising the stresses in the wall, but its stability as a whole may be seriously endangered.

Besides overturning, it is, however, also necessary to provide against the retaining wall sliding forward as a whole. This may be guarded against by carrying the underside of the footings a sufficient distance below the surface of the ground.

Rankine's formula may be used to determine the minimum depth required for any material. Referring to Fig. 126, and denoting by h_1 the depth of the foundation below the earth, the horizontal pressure which may be exerted at any depth h , before movement of the soil will occur, is given by

$$p = wh \frac{1 + \sin \theta}{1 - \sin \theta}$$

and consequently the total pressure which can be exerted on the depth h_1 is given by the formula

$$P = \frac{wh_1^2}{2} \left(\frac{1 + \sin \theta}{1 - \sin \theta} \right)$$

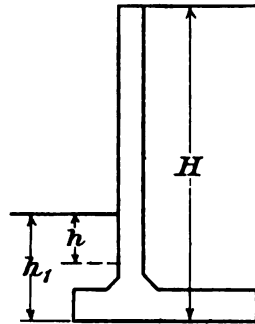

FIG. 126.

θ being the angle of repose of the material against which the retaining wall is built. To prevent sliding it is therefore sufficient to see that the pressure exerted by the retained material does not exceed this value. Generally, too, the friction under the base may be taken into account in resisting forward sliding, the safe value of the coefficient of friction for this purpose depending very much on the amount of moisture which may be present under unfavourable conditions. Where water is present it is most likely to have access when the base is so short in relation to the height of the wall that no pressure exists under the back edge of the heel, a condition frequently met with in practice. For this reason it is desirable to be as generous as possible in determining the width of the footing. When the wall is likely to be subjected to severe frosts the upper surface of the retained earth may expand and exert a great pressure, tending to overturn the wall. This may be partly relieved by shaping the top of the retaining wall as shown in Fig. 127. This form of construction has been adopted in several walls of mass concrete, but is, of course, equally well adapted to reinforced concrete walls.



FIG. 127. — Sloping top of retaining wall to relieve expansion from frost.

A point which requires great care in the design of retaining

walls is the connection between the front face and the footing, the question of securing the necessary bond to the bars in tension requiring special consideration. It is always advisable to provide large haunches between the footing and the vertical slab. It should also be remembered that in type (c) the earth tends to push the face wall off the buttresses, and ties must therefore be inserted.

Example.—An example will be given of a design of a retaining wall of type (a), having the dimensions shown in Fig. 128.

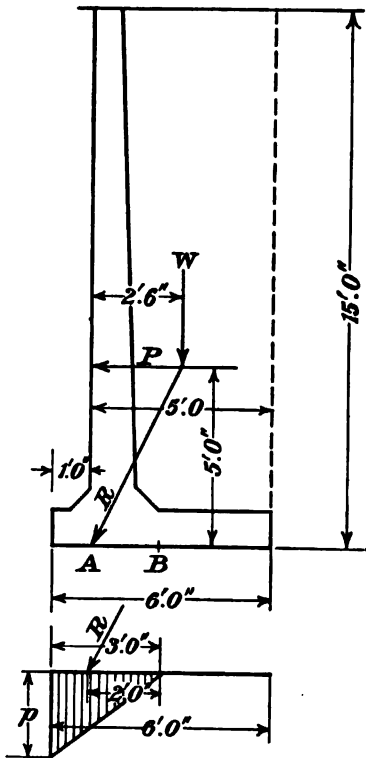

FIG. 128.—Example.

The material to be retained has an angle of repose of 30° , for which the value of $\sin \theta$ is $\frac{1}{2}$, and the expression $\frac{1 - \sin \theta}{1 + \sin \theta}$ is therefore $\frac{1}{3}$.

The total horizontal pressure on the wall, assuming the material to weigh 120 lbs./ft.³, will therefore be given by

$$\begin{aligned} P &= \frac{wh^2}{2} \left(\frac{1 - \sin \theta}{1 + \sin \theta} \right) \\ &= \frac{120 \times 225}{2 \times 3} \\ &= 4500 \text{ lbs. per foot run of wall.} \end{aligned}$$

This pressure acts at a height of 5 ft. above the foundations, and the total overturning moment is therefore

$$\begin{aligned} M &= 4500 \times 60 \\ &= 270,000 \text{ lb.-ins.} \end{aligned}$$

The distribution of pressure on the underside of a footing may now be considered, and for our purpose it is near enough to take the weight of earth resisting overturning as being 15 ft. deep and 5 ft. wide, giving a weight per foot run of wall of

$$\begin{aligned} W &= 15 \times 5 \times 120 \\ &= 9000 \text{ lbs.} \end{aligned}$$

This acts at a distance of 2 ft. 6 ins. behind the front face of the wall. From the intersection of W and P , the resultant of these two forces may be drawn, and will be found to intersect the under side of the footing at a point 12 ins. from the front edge of the toe, which in this particular example happens to be the line of the front face of the wall. The eccentricity of this force is therefore 2 ft. The average pressure on the soil is $\frac{9000}{6} = 1500$ lbs./ft.² If the eccentricity were small, that is, less than $\frac{1}{3}$ th of the width of the wall, the maximum pressure under the front edge of the toe would be obtained by multiplying this average pressure by the expression

$$1 + \frac{6e}{d}$$

where e is the eccentricity, and d the width of the base. When, however, the eccentricity exceeds $\frac{d}{6}$, the application of this formula will involve the assumption of a tensile stress, between the footing and the sub-soil, at the back edge of the heel. Since, however, this tension cannot exist, the distribution of the pressure is amended and takes the form of a triangle, at the centre of gravity of which the resultant acts. In our case the width of this triangle will therefore need to be 3 ft., as shown in Fig. 128. The area of the shaded figure representing the sum of the upward forces must equate the sum of the downward forces, which is 9000 lbs., and consequently we get

$$\frac{p \times 3}{2} = 9000 \text{ lbs.}$$

whence

$$p = 6000 \text{ lbs./ft.}^2$$

It will be seen that this pressure is considerable, and would only be safe in the case of a good sub-soil. If it were desired to reduce this pressure, it could be conveniently done by increasing the projection of the toe.

Coming now to the determination of the stresses or proportions of the different portions of the wall, consider first the

vertical slab. As the base will have a thickness of not less than 1 ft., we need only consider the bending moment at a section 14 ft. below the free surface; the bending moment at this section will therefore be $270,000 \times (\frac{1}{3})^3 = 220,000$ lb.-ins.

Adopting 0.675 per cent. of steel and stresses of 600 and 16,000 lbs./ins.², the value of d required will be

$$\begin{aligned} d &= \sqrt{\frac{220,000}{95 \times 12}} \\ &= 13.9 \text{ ins.} \end{aligned}$$

Considering the conditions under which a retaining wall is usually built—which are not of the best, as it is frequently difficult to ensure that no particles of clay or other soil find their way into the concrete, and also that the bars are placed exactly as shown on the drawings—it is important not to provide too small a cover of concrete over the bars, and in this particular example a suitable dimension for the total thickness of the wall at the base would be 18 ins. As the bending moment falls off rapidly towards the top of the wall, the thickness may be reduced also, and the top of the wall may be made 9 ins. thick. The area of steel per foot run of wall near the base will be given by

$$\frac{0.675 \times 13.9 \times 12}{100} = 1.12 \text{ ins.}^2$$

A suitable arrangement of steel would therefore be $1\frac{1}{4}$ -in. bars, arranged vertically near the back face with a distance apart of 12 ins. Owing to the reduction of bending moment towards the top which follows the curve of a cubic parabola, it is not necessary to carry all the bars right up, and half of them may in this case be stopped at a point 7 ft. from the top of the wall. To fix the lower end of the bars it will be found essential to provide a hook of the greatest possible efficiency. A bar about $1\frac{1}{2}$ ins. in diameter may be used to distribute the pressure over a larger area of concrete if these $1\frac{1}{4}$ -in. bars are hooked as in Fig. 129.

Referring now to the design of the toe, it will be seen from the pressure diagram (Fig. 130) that the pressure at the front edge is 6000 lbs./ft.², and 4000 lbs./ft.² immediately under the

front face. The total upward pressure on the toe is therefore in this case 5000 lbs., acting at a radius of about 7 ins., and giving a moment of 35,000 lb.-ins. From this the area of steel required can easily be determined. The depth of the toe must,

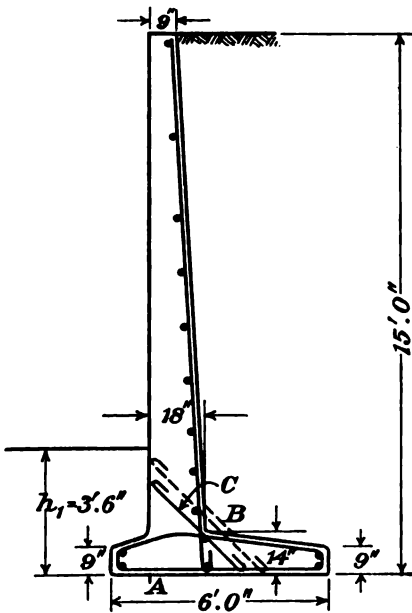

FIG. 129.—Reinforcement of retaining wall.

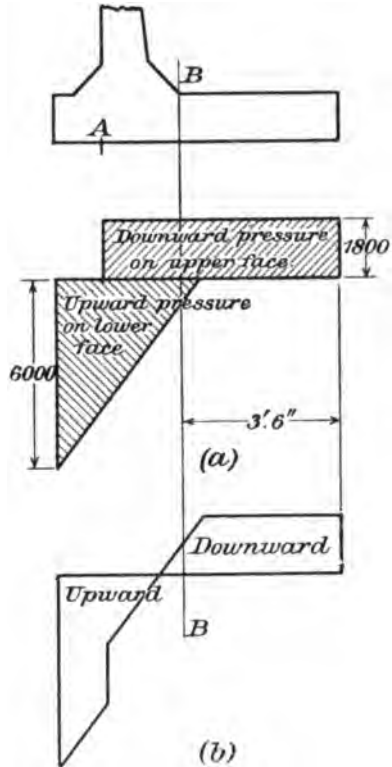

FIG. 130.—Unbalanced pressure on footing.

however, be determined rather from considerations of shearing stress for so short a cantilever. A depth of 12 ins. would give a shearing stress of $\frac{5000}{144} = 35$ lbs./ins.², which is therefore quite safe.

As the resisting moment of the wall is made up of the moment on the toe and that on the heel, and must equal the

overturning moment, we can at once obtain the approximate bending moment in the heel as being the difference between the overturning moment and the moment in the toe. It is, therefore, in our particular example,

$$270,000 - 35,000 = 235,000 \text{ lb.-ins.}$$

In this particular example, this moment is approximately the same as that found for the lowest section of the vertical face, and the same dimensions as regards thickness and arrangement of steel might therefore be used. This is really the moment in the heel at the point A,* and it is considerably less at the point B.

To calculate the bending moment at the point B, it is necessary to consider the pressures acting on the footings, which are shown diagrammatically in Fig. 130(a). The upward pressure of the lower face is represented by a triangle giving a pressure of 6000 lbs./ft.² at the front edge of the toe, running down to zero at a distance of 3 ft. from the front of the toe. The downward pressure on the upper face of the footing will be merely the dead weight of the soil, and is in this case

$$15 \times 120 = 1800 \text{ lbs./ft.}^2$$

The actual pressure causing bending moments is the difference between these two, which is shown in Fig. 130(b). In our particular case it will be seen that the unbalanced pressure to the right of the point B may with sufficient accuracy be taken as a constant, having a value of 1800 lbs./ft.², since the small triangle which is actually cut off near the point B is so close as to exert no appreciable bending moment.

We may therefore take the actual bending moment at the point B as

$$M = 1800 \times 3\frac{1}{2} \times \frac{3\frac{1}{2}}{2} \times 12 = 132,000 \text{ lb.-ins.}$$

It will be found that to resist this bending moment the thickness of the heel at the point B will require to be 14 ins. over all, allowing ample cover of concrete for the same reason as stated before.

* Since the toe moment of 85,000 was taken to this point.

In this particular example it happens that the shape of the unbalanced pressure curve makes the calculation of the moments at the point B a simple matter. This is, however, not always the case. If, for example, the material to be retained by the wall under consideration had exerted only half the pressure on the back of the wall, the pressure diagram on the base would be as indicated on Fig. 131.

Whatever the shape of this pressure diagram, however, no real difficulty will be found in calculating the bending moments

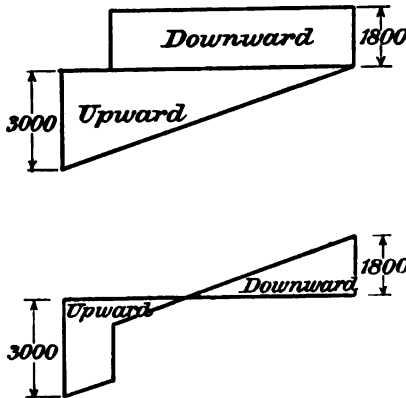

FIG. 131.—Unbalanced pressure on footing.

at any point in the heel or toe. It will be found difficult to arrange the steel in the toe and heel in such a way as to avoid heavy bond stresses. The arrangement shown in Fig. 129 or Fig. 124 (b) would, however, be suitable.

The maximum tension in the footing bars will occur at the point A, at the underside of the toe, and at the point B on the upper surface of the heel. The joint is greatly strengthened by the addition of the haunch bars marked C, and would be further strengthened by the addition of a haunch shown dotted, with the haunch bars lifted, as indicated by dotted lines.

Coming now to the question of the sliding forward of the retaining wall, the forward pressure of the retained material is 4500 lbs. per foot run. If the material against which the wall is built has a value of $\sin \theta = \frac{1}{2}$, the value of $\frac{1 + \sin \theta}{1 - \sin \theta} = 3$,

and consequently the safe pressure which can be exerted for a depth h_1 will be

$$\begin{aligned} P &= \frac{120(1 + \sin \theta)}{2(1 - \sin \theta)} h_1^2 \\ &= 180 h_1^2, \end{aligned}$$

whence substituting for P its value 4500 lbs., we have

$$\begin{aligned} h_1 &= \sqrt{\frac{4500}{180}} \\ &= 5 \text{ ft.} \end{aligned}$$

If the frictional resistance of the wall were neglected, it would therefore be necessary to build the underside of the footings 5 ft. below the ground-level. If, however, the friction due to the weight of the wall be taken into account, a smaller depth may be sufficient. If, for instance, in this particular case the coefficient of friction of the concrete and the earth beneath it might be taken as $\frac{1}{4}$, the frictional resistance to sliding would be $\frac{9000}{4} = 2250$, and would therefore account for half the horizontal pressure exerted by the retained material. In that case a depth of $h_1 = 3\frac{1}{2}$ ft. would be sufficient to resist the remainder.

In connection with this question of forward sliding, it may be noticed that if the heel had been continued further back the weight of the wall would have been increased, and consequently, also, the frictional resistance; so that from this point of view also it is desirable to make the heel as long as possible.

CHAPTER XII

SPECIFICATIONS

It is hoped that the following notes * on specifications may prove useful and suggestive. They would, of course, be varied considerably under special conditions.

General.—A specification should contain a full description of the conditions under which the work has to be executed, and a description of the building or structure required, accompanied by full drawings.

Drawings.—These should not generally be to a scale smaller than $\frac{1}{8}$ in. to 1 ft. ($\frac{1}{8}$).

Variations.—It should be clearly stated whether any variation will be permitted. For example, if the spacing of columns and beams is given, it must be stated whether any alternative arrangement, which may be cheaper, would be considered. One of the objects of the specification should be to ensure that the designer understands exactly what is wanted.

Foundations.—As regards foundations, one of two courses may be adopted. Either the safe pressure will be left to the designers, in which case all the available information, such as a geological section of the soil, should be given in the specification. It must be admitted that this course is unfair to the designer who allows for ample foundations, and it is not in the architect's interest to have these of doubtful carrying capacity.

The alternative is to specify the pressure per square foot. In this case, calculations of loads must be asked for, and must be checked.

In the case of footings in which the column does not rest

* Most of the suggestions given here are made on the assumption that an architect is preparing his specification with the intention of inviting competitive designs and tenders. As explained in the text, the authors consider this system open to grave objections.

on the centroid of the footing—as, for example, in the case of wall columns where the footing may not project into the neighbour's property—the specified pressure is to be the maximum and not the average. Such footings should, however, be avoided as far as possible.

Column Loads.—Where a building has several floors and the architect considers that a reduction of load may be made on the lower tiers, owing to the unlikelihood of all floors being simultaneously loaded, this allowance should be carefully specified and calculations called for and checked. It is, however, of no use to specify the loads on the columns unless the stresses allowed are also specified, and stresses should not be specified unless it is stated how they are to be calculated; whether, for example, bending moments due to unequal loading are to be allowed for, and what value is to be given for $\frac{E_c}{E_s}$ and for the lateral binding.*

Floor Loads.—As regards the floors, the loads must be given. These may be expressed as a live load of so many pounds per square foot. The determination of these loads calls for considerable judgment, and affects the cost of the building to no small extent.

For office buildings and schools, $\frac{3}{4}$ cwt. is an ample allowance, while for warehouses, or factories, the load varies so much in different cases that no general average is of much assistance. It may be stated, however, that a superload of 2 to 3 cwts. is very rarely exceeded.

For structures subjected to concentrated loads, it is advisable to specify that this load may be applied at any point without causing any signs of failure. This precaution is sometimes useful in preventing the adoption of a very thin slab and beams close together, which might be strong enough to resist the uniform load, but too weak to resist the point loads. Examples of structures where this is desirable may easily be found; even in an office, a heavy safe may produce the effect of a concentrated load, especially during its erection.

* It is obvious, however, that such matters are really questions which should be decided by the specialist. In fact, to work on this system either entails tying the specialist's hands, or else leaving the conditions so lax as to be unfair.

The specification of live load on roofs should state whether this includes the asphalt, etc.

To ensure an adequate factor of safety in the floors, one of two things may be specified. Either the stresses not to be exceeded may be stipulated, in which case it is necessary to state how such stresses are to be calculated, and what allowance for bending moments at midspan and at the support is to be made, or calculations must be demanded and checked to ensure that these stipulations are complied with. In this case, again, the specialist is prevented from using his technical knowledge, and the architect takes it upon himself to specify things of which he can have but little knowledge. Also this course may lead to waste of material and unnecessary cost of the structure, since his allowance for bending moments—which will probably be $\frac{wl^2}{12}$ at midspan—will in many places be too high.

The alternative is to give the load, and to specify that any portion of the floor may, at the architect's discretion, be subjected to a test load, and that if any signs of failure are manifested during such a test, the floors shall be strengthened at the contractor's expense until they are capable of carrying the test load in a satisfactory manner. This clause may be a deterrent to undue cutting, but can hardly be much more, since it is seldom a practical proposition to amend a reinforced concrete structure after completion. Perhaps it would be wise for the architect to retain the power to order the rebuilding of any portion of the work which fails to pass the test load, or, at his discretion, to accept the structure on behalf of his client at a reduced price. It must be admitted that neither of these is a pleasant outlook for the architect, since he either suffers delay, or else has a structure of doubtful strength.

Test Loads.—The amount of the test load should be stated; generally one and a quarter times the working load should be sufficient, although a higher test is sometimes demanded. This is, in the authors' opinion, a mistake, since such a load may overstrain portions of the structure and produce weaknesses which may not show themselves at the time, but may in course of time cause progressive failure.

An increase in the applied live load causes higher stresses to be induced than is accounted for by the percentage increase of the total load.

This is due to the fact that besides increasing the total load, the ratio $\frac{w}{w_d}$ is largely increased as well.

This is not generally recognized, but may be seen from the following example.

Consider an interior span of a certain beam for which

$$\begin{aligned}w_d &= 600 \\w_t &= 1200 \\ \text{whence } w_t &= 1800\end{aligned}$$

The centre moment is given by

$$\begin{aligned}M &= l^2 \left(\frac{w_t}{12} - \frac{w_d}{24} \right) \text{ (see Chap. VIII., p. 165)} \\ &= (150 - 25)l^2 \\ &= 125l^2.\end{aligned}$$

Suppose now a test load of 125 per cent. of the working load to be applied; we have

$$\begin{aligned}w_d &= 600 \\w_t &= 1500 \\w_t &= 2100.\end{aligned}$$

The centre moment is then given by

$$\begin{aligned}M &= l^2(175 - 25) \\ &= 150l^2.\end{aligned}$$

It will therefore be seen that an increase of $\frac{300}{1800} = 16.6$ per cent. in the total load, produces an increase of $\frac{25}{125} = 20$ per cent. in the stress.

It will be seen that many of the questions involved in the drafting of a good specification for work under this system are of so technical a nature that the architect would do well to have his specification drawn up for him by a specialist, to whom the checking of the designs would also be entrusted.

The alternative, and in the author's opinion the better method, is to entrust such a specialist with the design without inviting competitive designs at all.

Materials specified.—If the stresses are specified, it is necessary to specify minutely the composition of the concrete, the quality of cement, the amount of mixing and ramming to be allowed for—the provision of a machine mixer of approved type* is a useful clause on a large contract, since its use certainly makes for well-mixed and uniform concrete—the cleanliness of sand and ballast, and the maximum size of particles allowed.

It is, however, a useful precaution to insert a clause to the effect that these proportions may be altered at the discretion of the architect or his adviser, if necessary. It was stated in Chap. I. (see p. 16) that the best ratio of sand to stone depends upon the percentage of voids in each, and can only be determined by means of tests. Hence the value of this clause in cases where the usual proportions do not give the best results, owing to the particular stone or sand having a greater or smaller percentage of voids than usual.

If, however, the application of the test load is the architect's guarantee of strength, he may leave to the specialist and his contractor the choice of materials. In any case, he will do well to ensure that the construction and materials are to the satisfaction of the specialist who has designed the work. This may be done by specifying that the specialist shall include in his fee a sum sufficient to allow for providing the necessary supervision, and that before submitting his tender the contractor shall acquaint himself with the quality of materials which the specialist will require. With these two clauses, it should be possible to get the specialist and contractor to work in harmony.

Finish.—It is important to specify what finish is required—whether, for example, the work is to be as left from centering, or whether it is to be plastered.

In this connection it may be stated that a good surface obtained by the use of carefully made centering and good concrete is far preferable to that obtained by the use of a plaster added afterwards, since the latter is more liable to come away or to show surface cracks.

Where a very fine finish is required—for the interiors of offices or dwellings—this does not apply so much, as a plaster

* It should be of the "batch" type, as opposed to a continuous mixer.

is necessary in such cases, but for external work, at any rate, any thick coating should be avoided as far as possible.

Where the surface of the concrete is to be left, it is desirable to use the same sand and ballast—*i.e.* from the same pit—throughout the work, if possible, in order to obtain a uniform colour on the face of the concrete.

For factories and the like, it is frequently sufficient to make good any irregularities with cement mortar, rubbing over the surface, and whitewashing.

It should be stated whether the floors are to be left with spade finish, or specially prepared for any special covering. If they are to be covered with granolithic—granite chippings about $\frac{3}{8}$ in. mesh and cement—this should be specified, and the thickness stated.

Granolithic certainly makes a good hard wearing surface. It is important to be quite clear as to whether the granolithic finish is included in the thickness of the slab, or whether it is laid on as an additional thickness.

The question as to whether it may be included in the calculated thickness of slab is important where stresses are specified and calculations asked for. The advisability of allowing this depends considerably on the length of time which elapses between the placing of the slab concrete and the granolithic. If it can be ensured that this will not exceed six hours—though this is frequently difficult—and when the thickness of granolithic is not too small, it is probably quite safe to allow for it in the calculations for moment of resistance at midspan of the slab. Whether it may be allowed for at the beams depends upon the position of the slab bars at this point.

If it is intended to cover the floors with boarding, battens are required at about 2 ft. centres to which the boards may be nailed. It is important that these battens should not under any circumstances be allowed to project into the thickness of the slab, which would be greatly weakened by such a construction. The concrete floor should be finished first and allowed to set, and the battens should then be laid, and fixed, if necessary, by the use of cinder or other concrete laid for this purpose, and not allowed for in the calculations of the strength of the slab.

Centering.—The construction of the centering requires con-

siderable attention. The architect is interested in ensuring that his beams and columns shall be true and straight. To insure this his best course is to employ a first-class contractor, in which case it may be sufficient to specify that this shall be attended to, and that details of the centering shall be subject to his approval.

Alternatively, he must specify minutely the thickness of the boards for various portions of the work, and the maximum distance between cross battens, and cramps or cross wires.

For example, 1½-in. boards, machine-planed on one side, are suitable for beam sides, and cross battens at 4 ft. centres, cramped at each cross batten, will generally be stiff enough when the layer of concrete deposited at a time does not exceed 3 ft. in depth.

Vibration.—It is very important that the concrete should not be subjected to vibration while it is setting. This calls for the use of stiff and well-braced centering. Any precautions which can be taken to avoid such vibration are important. For example, if a bridge be built in two halves—which is sometimes the case in the reconstruction of an existing bridge—heavy loads should not be permitted on one half while the concrete on the other is green unless the two are completely isolated.

In a water tower, considerable cross-bracing is necessary to prevent vibration from the wind, and in pier and harbour work very stiff temporary work is essential to prevent undue vibration being produced by the action of the waves. The latter is so important that it may be desirable to adopt pieces made on shore and jointed in place. See, for example, Mr. C. P. Taylor's paper on "The Construction of Swanscombe Pier," *Concrete Institute Proceedings* (vol. ii. Part 3, 1911). In this case the columns were made in blocks of 4 ft. 6 ins. to 5 ft. 6 ins. in diameter and 3 ft. deep, and were assembled *in situ*. These blocks were so massive that the vibration was insufficient to affect the strength of joint. In the construction of the superstructure, the portion of the pier on which pile-driving was in progress was isolated from that portion on which concrete was setting.

Camber.—It is important to give beams a camber of about ¼ in. in spans of 20 ft., so that when the concrete has been

placed, the sag of centering due to yielding or settlement of the props, added to the deflection of the beam under its load when the centering is subsequently removed, will still leave the soffit slightly hog-backed rather than sagging.

Striking Centers.—The time which must elapse between concreting and striking of centers depends upon the temperature, as concrete which will set quickly in warm weather may not set at all in winter-time. For this reason, it is not advisable to specify a definite time, but to leave it to the judgment of the specialist. It also depends upon the factor of safety in the design, the ratio of live to dead load, and several other considerations. As, however, several mishaps have occurred through its too early removal, the specification should certainly refer to it, and state that the contractor may not strike the centering of any work without permission from the specialist, in approved form.

Frost.—No concreting should be allowed with a temperature below 34° F., as the risk of damage by frost is very serious.

Inspection.—In all reinforced concrete work, it is extremely important that the steel, after being arranged in the moulds, should be examined by a thoroughly qualified inspector, responsible to the specialist or consulting engineer, and passed by him before any concreting is begun. This inspection is skilled work, as experience enables a man to detect errors very quickly, and teaches an inspector what errors are likely to occur and are to be guarded against. Arrangements must also be made to ensure that the bars be not displaced during concreting. This danger is greater than is realized by many, as considerable force is required in the punning of the concrete. It is obvious that such displacements may be extremely serious should they occur, and that the elaborate and careful calculations of the office must not be jeopardized by a little extra zeal on the part of a workman.

Wiring Bars.—The danger is largely reduced by an adequate wiring of intersecting bars, and may in some cases warrant the use of bars for this purpose—a point which is not lost on an experienced and careful designer. As this wiring may be irksome to the contractor, some reference may well be made to it in the specification.

Leaving Holes.—It is not good to cut holes through concrete

slabs and beams except where it is unavoidable. When careful planning will enable the architect to foresee where holes will be required,* pieces of pipe may be left in the slabs and beams to form these holes. This should be mentioned in the specification, and the holes and piping referred to in the quantities.

Maximum Depth of Beams.—To carry a certain load over a given span, several designs are generally possible, and the cheapest arrangement may not be that which will suit the client's requirements. Generally the depth of the cheapest beam is greater than is desirable. For this reason, it is a good plan for the architect to specify the maximum depth which will be allowed, both for slab, secondary beams, and main beams.

Maximum Size of Columns.—Similarly, the cheapest columns to carry safely the necessary loads will frequently be larger in the lower tiers than is desirable for architectural considerations. For this reason, it is a good plan to specify the maximum which can be permitted, and, where this is particularly important, to indicate that preference will be given to a design in which this size is kept down to a minimum. This requires the use of more steel, and will therefore be more expensive, so that an architect should realize, in judging between the designs, that he must not expect the best design, from this point of view, to be the cheapest also.

Plain Concrete under Footing.—In some cases it is a good plan to specify a certain thickness of plain concrete under the reinforced footings. This will, for example, ensure that the steel will be protected by a layer of concrete from the action of rust, which protection would otherwise be uncertain in this place.

Where the foundations have to be carried below the level of surface water, it is good to bring the foundations above this level with mass concrete, and build the reinforced work above water-line, though this may in some cases cost too much to make it worth while.

Test Blocks.—It is always interesting to have test blocks made of the concrete used. Such blocks serve to indicate whether the concrete is as good as was anticipated, and may

* For sprinklers, for example.

postpone the application of a test load in cases when, for some reason, this is not found to be so, and the test would be dangerous.

They also may give some indication whether, in case of a fault, this is due to bad design or bad execution.

Test blocks should not be less than 6-in. cube. Wooden moulds should not be used, as they suck the water from the concrete, and give very low crushing strength. Machined cast-iron moulds are best, but are, unfortunately, expensive. Not less than two cubes should be taken to test any gauging, and the concrete should, of course, be taken straight from the gauging board or mixer, and not specially mixed.

When testing, it is extremely important that the load shall be centrally applied, and that the pressure shall be uniformly applied to the surface. To do this requires a testing machine, fitted with a ball and socket joint, and the surface of the cube should be made true with plaster.

FIRE-RESISTING CONSTRUCTIONS.

The notes on p. 15 may be referred to as to the choice of materials for fire-proof construction. The Fire Offices Committee issued on June 20, 1911, rules for the construction of buildings of the warehouse or mill type to be deemed of Standard IA construction, and appended special rules for reinforced concrete construction, which are given below.

Buildings constructed with concrete reinforced in every part with embedded metal rods or bars spaced not more than 12 ins. apart, securely connected or overlapping at least 6-ins. at all abutments and intersections, having also bands or bars across the thickness of the concrete, may be deemed of Standard IA construction provided they conform to certain rules * with the following modifications.

Rule 3.—Concrete may be composed of sand and gravel that will pass through a $\frac{3}{4}$ -in. mesh, or of the other materials

* These rules relate mainly to the arrangement of the openings, etc., in the structure.

mentioned in the rule, but in any case the cement used must be Portland (equal to the British Standard Specification of December, 1904), in the proportion of 6 cwt. of cement to each cubic yard of concrete. The concrete must be thoroughly mixed both dry and wet, and must be rammed round the metalwork in position, every part of which must be completely enclosed with solid concrete.

Rule 4.—No external wall to be less than 6 ins., and no division wall less than 8 ins. No party wall to be less than 13 ins. thick in any part unless the adjoining building be of reinforced concrete in accordance with Standard IA, IB, or II, in which 8 ins. is allowed.

Rule 7.—Flues may be built of reinforced concrete as described not less than 4 ins. thick, if lined throughout with fire clay tubes not less than $1\frac{1}{2}$ ins. thick. No timber or woodwork to be in contact with such flue.

Rules 10 and 11.—Floors must be constructed of reinforced concrete as described not less than 5 ins. thick in any part, without woodwork bedded therein, supported on beams and columns of similar reinforced concrete.

Rule 13.—Roofs must be constructed in a similar manner to floors, the concrete in no part to be less than 3 ins. thick.

Rules 14, 15, and 16.—All structural metalwork must be embedded in solid concrete, so that no part of any rod or bar shall be nearer the face of the concrete than double its diameter; such thickness of concrete must in no case be less than 1 in., but need not be more than 2 ins.

Rule 18.—Enclosure to staircase and hoist, if of reinforced concrete as described, may be 6 ins. in thickness.

Rule 22.—Fire-proof compartments in connection with reinforced structures must also be of reinforced concrete as described, with walls not less than 8 ins. and floors not less than 5 ins. in thickness.

As it is frequently possible to obtain a reduced premium from the insurance companies when these rules are conformed to, it will often be desirable to follow them in every respect without questioning the necessity for all the provisions. Particular attention is drawn to Rules 14, 15, and 16, which state that no part of any rod or bar shall be nearer the base of

the concrete than double its diameter, and never less than 1 in. It will be seen that this affects considerably the design of slabs where $\frac{1}{2}$ in. cover is generally considered sufficient, and in the case of a thin slab such as a roof, carrying little but itself, the increased weight is considerable.

CHAPTER XIII

QUANTITIES AND NOTES ON PRACTICAL APPLICATIONS

QUANTITIES.

QUANTITIES for reinforced concrete are sometimes made out in a way which leaves much room for improvement. The ideal which the surveyor should approach as closely as may be, is that his bill of quantities should be sufficient to enable a contractor to put a fair price on the work. Hence it is not sufficient to give the volume of concrete and tonnage of steel, but the centering must be measured, and the different kinds of work carefully separated.

Height above Ground.—For example, a yard of flooring on a fifth floor costs more than on a ground floor, other things being equal, and consequently, the height of any work should be mentioned before the figures relating to it.

Floor Height.—Similarly, the height from floor to floor affects the length of props required, and must therefore appear on the bill.

Concrete.—The quantity of concrete should be given in cubic yards of finished work.

Centering.—The centering is generally given in squares for slabs, wall surfaces, etc., and in square feet for beams, columns, etc.

It is best to make no special allowances for intersections of beams with one another, or for columns with beams, but to give the exact net superficial area, and state that this has been done.

Chases.—It frequently happens that slabs are supported by brick walls, and built into chases in the wall. In the calculation of the volume of concrete the chase should be included,

while for the centering the net area under the slab is sufficient. Where the chase has to be cut in existing work, the cutting should, of course, be given as a separate item, giving the lineal feet of chase and the required section.

Centering of Sloping Surfaces.—Where sloping surfaces are given it may be doubtful whether one or both sides are to be centered. Generally, a slope of less than 30° can be made without top centering, but, for 30° or over, double centering should be allowed for. In any case, it is important to state whether one or both surfaces are included in the area. Thus—

Outside Wall.

30 — squares centering, both sides measured

would imply that the area of wall was 1500 square feet, but as both sides had to be centered, 3000 square feet of centering would have to be provided for.

Generally, it is not necessary to center the upper surface of footings of the usual flat slab type.

Where centering is curved, or has any special work to be done on it, this must, of course, be stated and described.

Steel.—The steel may be given in tons or cwts. It is desirable to keep stirrups separate from other steel, as they usually cost considerably more per ton in place. Even $\frac{3}{8}$ in. and $\frac{7}{8}$ in. diameter rods cost more per ton than larger sizes at the works.

The bending and assembling of the steel in the moulds is no inconsiderable item in the cost. The only way to deal with these at present would seem to be to require the designer to prepare typical details of the arrangement of steelwork in beams, columns, slabs, walls, which need only be sufficient to enable the contractor to estimate this work by a comparison with previous jobs.

It is desirable to state whether the steel is mild or hard, since the latter costs slightly more to bend, and its prime cost is also higher.

ADDITIONAL NOTES ON APPLICATIONS OF REINFORCED
CONCRETE.

Concrete and Brick Piers.—As far as possible, continuous structures should rest entirely on brick supports, or entirely on concrete columns.

The reason for this is that the modulus of elasticity of concrete is much greater than that of brick piers,* which has the effect of causing a brick column to shorten more under the action of load than a concrete column. This would render the calculations of stresses very uncertain, and cause cracks in the beams.

An instance came to the notice of the authors of a structure in which every second support was an existing brick pier, while the intermediates were new concrete columns. Cracks in the beams had resulted.

In addition to its low coefficient of elasticity, brickwork expands and contracts under many atmospheric and other influences, as may be seen in the deflection of old walls and chimneys, originally straight.

4½-inch Brick Walls.—On no account should a 4½-in. brick wall be used to support a floor, even if the load/ins.² appears to be quite low. It is far better to carry the floor by a beam, and finish the partition wall afterwards.

Foundation Rafts.—Reinforced concrete is well adapted to the construction of foundation rafts, where it is necessary to distribute a concentrated load over a large area in order to obtain the necessary bearing capacity without excavating to a great depth.

Thus grain silos, which are frequently designed to store grain in bulk to heights of 50 ft. and more, may easily weigh 3000 lbs./ft.² of horizontal area, which is necessarily transmitted to the foundations by isolated columns, owing to the necessity of being able to run trolleys under the hoppers. A good foundation raft will transmit the load from the columns over the whole area of the site; this is preferable to the adoption of

* The modulus of brick piers is very variable, depending greatly on the nature of the mortar and on the brick. On an average, it varies from $\frac{1}{10}$ to $\frac{1}{30}$ of that for concrete—taking the latter at 2×10^6 lbs./ins.²

isolated footings, since the carrying capacity of the soil under such a raft is greatly increased by its inability to get away, just as the bearing capacity of even running sand is considerable if it be enclosed. The foundation under the tower of Kingsway Church (Messrs. Belcher and Joass, Architects) consists of such a raft.

Where local, as opposed to general, settlement is to be anticipated, considerable judgment is required in the determination of the stiffness which such a raft should have, since, under such circumstances, the raft has to be strong enough to transmit some of the load from the faulty soil on to that with greater carrying capacity.

Cases may even occur where the likelihood of unequal settlement is so great that the use of a foundation raft at all is inadvisable, and pile foundations should be resorted to. This is particularly so where the superstructure consists of reinforced concrete, in which case unequal settlement is very objectionable.

Concrete Piles.—For piles, reinforced concrete has many good points, as well as some disadvantages. Among the former, perhaps the chief is the immunity from rot or rust, which is obviously important in the case of buildings intended to stand for all time. For piers and wharves this is particularly important, since the condition of alternate wetting and drying is that which causes rapid rotting of timber and rapid rusting of steel. The objection to concrete piles lies in the time which must elapse between the placing of the order and the driving of the piles, as these cannot with safety be driven before they are four weeks old. Another objection is their increased weight over timber piles, which increases the difficulty of handling long lengths. For pier work, etc., the fact that the piles cannot be floated round to the pile engine may also be very inconvenient.

In some cases good results may be obtained by the use of such piles as the "Simplex," in which a hollow steel tube is driven into the ground, and concrete rammed into it while the tube is being withdrawn, leaving a column of concrete in the soil in a plastic condition, which will, however, set as usual. Such piles have, however, their objections also.

Concrete Chimneys.—The use of reinforced concrete for chimneys is of more recent date than its application for most other purposes.

In some cases chimneys of reinforced concrete have considerable advantages over chimneys of other materials. Thus when ratio of length to diameter is high, a brick chimney requires to have a great thickness at the base, since with brickwork no resistance to tension may be relied upon, and consequently the resultant pressure of weight and wind has to fall well within the circumference of the chimney. For this reason such chimneys are frequently much lighter and thinner, and somewhat cheaper when built in concrete. This reduction of weight reduces the size and cost of the foundations also, especially on bad soil.

In a particular chimney, recently completed by the firm of Trollope & Colls of London, in which the height from top of foundation was 145 ft. and the outside diameter only 5 ft., a brick chimney could not have been used at all owing to want of space.

One of the authors has made a special study of reinforced concrete chimneys, and has worked out, in co-operation with Messrs. C. P. Taylor and C. Glenday, formulæ and curves by which the design of chimneys for given stresses is reduced to a comparatively simple operation without any sacrifice in accuracy.*

The actual design involves, however, many things besides stresses from statical loads, and the question of temperature stresses requires very careful consideration, as will be shown in what follows. Great care has also to be exercised in the choice of aggregate for this purpose, since ordinary concrete does not well resist the action of the hot gases.

It may be stated generally, however, that under expert control reinforced concrete chimneys have frequently great advantages over other forms of construction, although it must be admitted that when the ratio of length of diameter is

* "The Design of Ferro-Concrete Chimneys," *Engineering*, March 18, 1908, by Messrs. Taylor, Glenday, and Faber. See also Mr. Taylor's contribution to the discussion of Mr. Matthews' paper on "Reinforced Concrete Chimney Construction," *Concrete Institute Proceedings*, vol. ii. part i. p. 51.

comparatively small, they do not compare so favourably as regards cost.

The chimney shaft mentioned above is illustrated by Figs. 132-134, and is probably remarkable in having the greatest ratio of length to outside diameter of any reinforced concrete chimney in existence. It is 144 ft. 9 ins. in height, measuring from the top of foundations, the outside diameter being only 5 ft. at this point. As will be seen from the figures, the diameter remains constant up to the top.

As a matter of interest, it may be stated here that the minimum dimensions which could have been adopted for a brick chimney of this height would have been as follows:—

			ft.	ins.
Outside diameter at the top	4	0
" " " base...	12	0
Wall thickness at the top	0	9
" " " base	3	0

It will be seen from this that the reinforced concrete shaft occupies very little space, and in this particular case this was the matter which was of the utmost importance, and determined the use of a concrete shaft.

The actual design is illustrated by the accompanying figures, from which it will be seen that the lower portion of the chimney, up to the flue entrance, is 1 ft. 3 ins. thick, and above that 6 ins. thick. Above the flue entrance a lining of firebrick 5 ins. thick is provided, with an air-space 4 ins. wide between it and the outside shell. Vent-holes are left near the flue entrance, through which a current of air is induced in the air-space between the liner and the outer shell.

Experience with several chimneys of this type has shown that the concrete shell is liable to crack badly under the heat of the chimney, and this fact has no doubt hindered to no small degree the progress of reinforced concrete for this purpose.

Some theoretical calculations of temperature stresses led the writer to a system of construction in which timber rings are embedded at intervals on the inside face of the concrete shell, which practically reduces to zero the stresses due to expansion. This system of construction, which is patented

by the writer, was adopted by the Associated Portland Cement Manufacturers in a chimney built by them at their works at Burham, on the Medway. This chimney has now been in use several months, and is quite free from any cracks due to temperature stresses.

The chimney illustrated here was also built on the same system, though, of course, its success here cannot be gauged at the time of writing.

The lightning conductors are four in number, and are screwed on to the tops of four of the longitudinal bars, thus saving the copper strip down the length of the chimney. Electrical connection was made between the lower ends of the bars and earth, and a test of the resistance between the spikes of the conductor and earth showed that the connections were all they should be. This is of interest, as no special precautions were taken to ensure good contact where the longitudinal bars lapped with those of the higher tier, the bars being simply lapped and held together by $\frac{1}{4}$ -in. U bolts.

The reinforcement used in the chimney was Indented Bars.

The foundation had to be taken down 15 ft. below basement level, which is itself 14 ft. 9 ins. below ground level, and as it was necessary to underpin existing walls under which it was built, it was made a

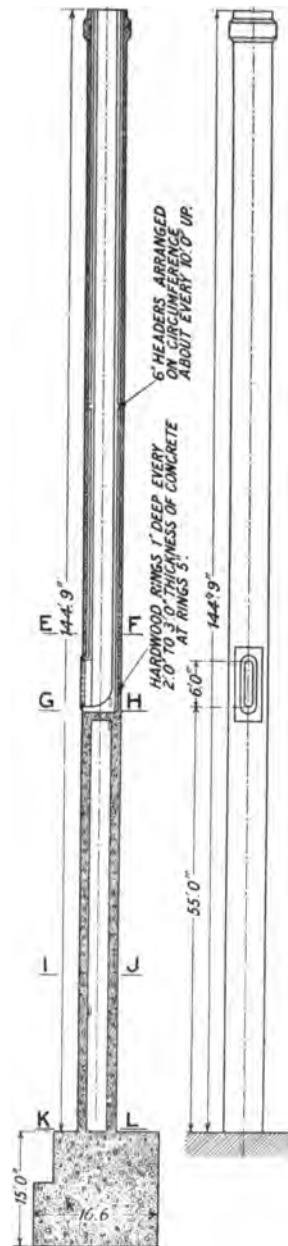

FIG. 132.—Concrete chimney erected by Messrs. Trollope and Colls.

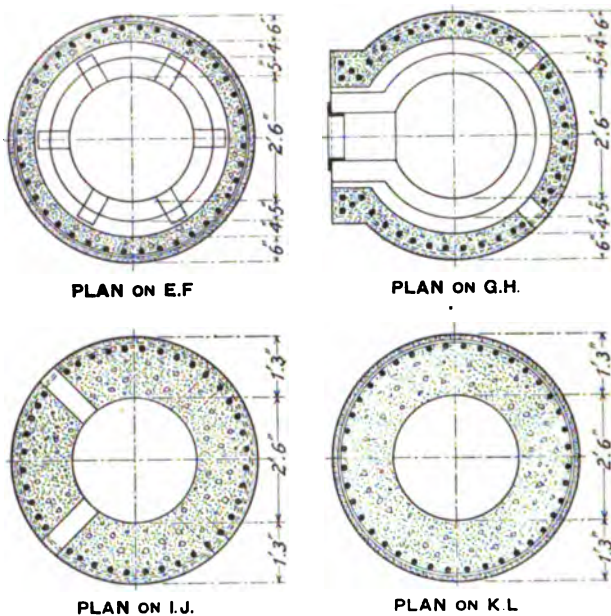

FIG. 133.—Sections of chimney.

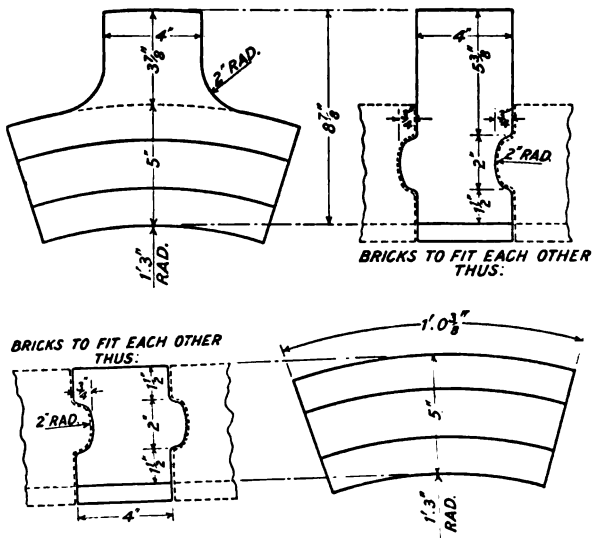

FIG. 134.—Plan and sections of fire-bricks.

solid block of concrete 16'-6" \times 14'-0", thus serving for the underpinning also.

NOTES FOR STUDENTS AND THE NEED FOR EXPERIMENTAL STUDY.

In conclusion, for the benefit of students a few notes may not be out of place with reference to the practical work which should accompany the theoretical study of the subject. In the first place, a study of such current literature as gives photographs of finished works and works in progress is to be recommended, as giving a knowledge of the conditions under which reinforced concrete work is carried out, which must be taken into account by a good designer.

In the second place, works in progress should be visited whenever opportunity offers, the ballast inspected, note taken of the wetness of the concrete, the amount of ramming done on it, and its effectiveness as shown by the presence or absence of voids when the forms are being removed, the difficulty of fixing and bending different shapes of bars and stirrups, and of assembling them in the moulds, and hundreds of such matters with which a designer must be acquainted in order to be able to render good service.

Thirdly, the authors are strongly of opinion that to obtain a really intimate knowledge of the behaviour of reinforced concrete, an experimental study is essential. Unfortunately, this is frequently difficult to obtain. Very few colleges in England provide facilities for this kind of work, and in those that do, the tests are frequently confined to such simple specimens that the full benefit of such experiments is hardly obtained.

Perhaps nothing puts one so well on guard against weaknesses in design as a careful experimental test to destruction of a series of beams or columns, and a comparison of ultimate loads by calculation and experiment gives confidence—or the reverse—in the theories underlying design. Experience of this nature is occasionally—and happily only very occasionally—afforded by tests of actual structures. A structure, if well designed, has a factor of safety of about two and a half.*

* Commonly called four. See, however, p. 9.

Hence, even if the test load is one and a half times the working load—and it is doubtful practice to apply such a test load—a structure has to be badly in fault as regards materials, construction, or design, for collapse to occur. Occasionally cracks occur which, without being sufficient to make the structure dangerous, indicate places where improvement may be made in future works. Obviously all such experience is extremely valuable, especially when going hand-in-hand with a thorough theoretical investigation, without which the true cause of fault or failure may be left undiscovered, and the danger may again be unwittingly incurred.

ELECTROLYTIC CORROSION OF REINFORCEMENTS.

When electric currents are passed through a structure of reinforced concrete in such a manner as to pass from one steel bar, through the concrete on to another steel bar, or to earth, electrolytic action is set up, the moist concrete acting as an electrolyte.

It has been demonstrated by numerous experiments that under these conditions the effect may be to cause the concrete to crack round the anode—the bar of higher potential—and that this will corrode very badly.

One of the authors made a number of experiments on the subject some years ago, which are confirmed by more recent investigations. A good account of some experimental work on the subject is given in the *Journal of the American Institution of Electrical Engineers*, May, 1911, by Messrs. Magnussen and Smith.

The main conclusions of experimental work appear to be as follows:—

Dry concrete is practically an insulator, and therefore unaffected by considerable potential differences or earth currents.

Moist concrete is a good electrolyte. The destruction of reinforced concrete by electrolytic action is due chiefly to the increase in volume of the anode consequent upon its corrosion or oxidation, which follows the liberation of oxygen at its surface.

Comparatively small currents are sufficient to produce great

damage. Thus a $\frac{3}{4}$ -in. diameter bar embedded 6 ins. in a concrete block standing in water, cracked the block in one day with a current of under 0.1 ampère.

In ordinary practice no trouble need be anticipated from this cause, since with the regulation of maximum voltage drops on the earth-returns of traction systems, and the increasing tendency to adopt insulated returns, earth currents are so small and of so low a potential as to be harmless. In particular cases where a possibility of abnormal voltages may exist, care is necessary to insulate the reinforced concrete. Such cases might be anticipated in bridges for electric railways and tramways. For ordinary constructions there is no evidence of any destruction of reinforced concrete from stray electric currents.

A useful precaution is also to earth the reinforcements. Generally all bars are in electrical contact, by being wired together, and in such cases it is only necessary to earth the reinforcement in one or two places. It is interesting to note that the electrical contact of steel bars wired together appears to be good even when no special precautions are taken to clear the surfaces.

Thus in the reinforced concrete chimney described above (p. 250), the vertical reinforcements were as mentioned used as lightning conductors. The joints consisted of laps, the two bars at a lap being held together by $\frac{1}{4}$ -in. V bolts, all steel being black. The lowest tier of bars was earthed, and a test of the resistance from the tip of the conductors to earth showed an extremely small resistance.

CHAPTER XIV

THE SPECIALIST ENGINEER

IN the knowledge of the behaviour of complicated structures of reinforced concrete, and in the art of fashioning the most suitable structure for a given purpose, a few specialists are so far ahead of the rest of their profession that they may truly be termed masters of their art.

In this sense the French specialists who first developed in England the practice of an art brought from their native land were masters, and insisted on being recognized as such in the terms on which they were willing to work for those English architects and engineers who had the courage to try the so-called "new" material.

The royalties were heavy, and no calculations of any kind were forthcoming. "Tell me what you want, and I will design your building," was their offer. "I guarantee its stability, and the rest is my business."

Time passed on, competition grew, prices fell. It was felt among English engineers that they must have a check against the adoption of reduced factors of safety to secure work—a real danger. Eventually a determined stand on the part of large and powerful bodies—railway companies, administrative departments, etc.—coupled with an experimental study of the material in American Universities, drew calculations from the specialists. But only those who have made a life-study of reinforced concrete are fully aware of the extent to which such calculations have frequently been utterly misleading.

Such reports as that of the Royal Institution of British Architects, and the many regulations, particularly those issued in France, have undoubtedly done much to lead engineers along

the right lines. But it is a long step from that to the idea that every man should now design his own concrete work. It is not denied that he can, and that if he makes his factor of safety sufficiently large to cover "factors of ignorance," his work will stand, provided some important consideration has not been inadvertently ignored. But even so, his work will be more expensive than that of the specialists, since on the one hand he has to find by laborious methods what a specialist has trained himself to see almost instinctively, and, secondly, because his "factor of ignorance" must be greater, and will therefore entail the use of more material to secure an equally safe structure.

There are very frequently many alternative designs possible, of which, for the same factor of safety in them all, one will be cheaper or generally more suitable than the others. To produce at once this design, is one of the fruits of experience.

In spite of the increasing knowledge of concrete work, the specialist's mastery is as great as ever; he still holds valuable information on questions which outsiders have not yet dreamt of, and answers to difficulties which they brave in ignorance only.

Let it be granted, then, that well-advised engineers and architects will call in a specialist to design for them their concrete work. They are confronted with several problems, though they probably thought their difficulties over long ere now. Firstly, what is to guide them in the choice of their specialist? They scan the list of experienced firms, and may find themselves committed to the use of a "system" or a patent bar, and the engineers of the firms in question will point out the merits of the "system" and the bars.

In sober judgment, the architect knows that the merits of a "system" or a patent bar essentially constitute a question for a specialist, and on mature consideration will realize that no "system" can be best in all cases, nor can a patent bar be adapted to every configuration without waste.

Surely the true specialist whom the architect or engineer will seek should not be fettered by allegiance to any "system" or bar, and should use in every contingency an arrangement of bars dictated solely by the science underlying his art.

THE CONTRACTOR.

With some materials, of which constructional steelwork is one, the strength of the finished structure depends to only a small degree on the contractor. Provided that the design has been made by a competent engineer—and such obvious checks are made upon the work as testing the tightness of rivets, correct fitting of parts, etc.—the strength of the structure will depend very little on what contractor is employed.

With reinforced concrete it is otherwise. Unless the designer gives continuous personal supervision, much is left to the contractor which is of vital importance to the safety of the structure.

Not only may errors be made knowingly by an unscrupulous contractor for his greater profit, such as the use of an insufficient quantity of cement, the omission of part of the reinforcement, or an insufficient expenditure of labour in the fixing of the steel in its correct position, the adequate tamping of the concrete, the use of cement grout in joining to old work, etc., etc., but even with a willing and conscientious contractor, errors may be made unwittingly. Thus the best position for a break in the work is important, and frequently far from obvious to a contractor. Again, the drawings supplied by the specialist may not be sufficiently clear, especially when it is remembered that they are to be read by a foreman with no particular qualification for solving Chinese puzzles.

Supervision of many works by contractors of undoubted conscientiousness has convinced the authors that the errors which may be made unwittingly are greater than is generally supposed.

This being granted, it behoves us to consider briefly what steps should be taken to prevent such errors.

Firstly, the scamping of work by a contractor. This is best guarded against by the employment of a first-class contractor only, to whom a reputation for doing the best work is of more value than the additional profit to be obtained by dishonest means on any one job.

In spite of open competitions, and the modern tendency

to consider cost as the ruling question without regard to quality, such firms may still be found. The employment of them at a slightly increased cost is certainly important for reinforced concrete, more so even than for building in other materials. The increased cost is frequently less than is at first sight apparent, since the supervision may then be reduced to seeing that the contractor understands exactly what is required. Further, the saving of worry, inconvenience, and time to the employers should not be omitted in the comparison.

The errors made unwittingly by a conscientious contractor may generally be traced to insufficient detailing by the engineer (for example, omission to state what cover of concrete should be given round the bars), or to the engineer taking for granted things which are not understood by the contractor. Such errors are avoided by the closest harmony between the engineer and contractor.

It is found that clear detailing depends largely on following rigidly certain conventions which must be understood by contractor and engineer alike. Now, different specialists adopt different conventions; for example, some will show, for greater clearness, the different bars in a beam at different levels, as in Fig. 2, when really the bars are required to be at the same level, but when the drawing would be confused if drawn so on a small scale. This convention is useful, but may be misleading to a contractor until he is used to it. Instances might be multiplied almost indefinitely.

It thus becomes obvious that the contractor must be experienced, not only with reinforced concrete, but with the particular system of detailing and arrangement employed by the designer of the building. This is obtained to the greatest perfection in the case of a firm in which the reinforced concrete department is in charge of a competent engineer, who may be entrusted with the design, and whose drawings and methods are thoroughly understood by the foremen under his charge, this harmony being, in fact, a valuable part of the organization of such a firm.

This system, under which the design and execution is entrusted to a first-class firm combining the functions of

design and execution, has many other advantages, amongst which may be mentioned the fact that the engineer in charge will have a close knowledge of prices, and thus be able to design for cheapness, and, secondly, that there ceases to be any division of responsibility between designer and contractor. This latter is of great advantage to the architects. We have in mind a case in which good contractors worked to a specification issued by the designer, with his full approval of materials and workmanship, and under his supervision. The test specimens of concrete failed to attain the strength expected from them, and the contractors naturally declined responsibility for the strength of the structure. This creates a difficult position for the architect, which would have been avoided, had the contractor been responsible for the design also.

The chief objection would appear to be that by giving the work to a specialist, associated with chosen first-class contractors, the architect has no control over the cost of the work. This is best met by a system of payment on a cost-*plus*-a-fixed-sum basis, or by a system of schedule prices.

The alternative is the system of competitive tenders and designs which at present still prevails to a considerable extent, and which yet bristles with objectionable features, both to builders, engineers, and owners. The chief of these are that the designer has every inducement to cut the quantity of the materials and the factor of safety below the accepted value; that the best design may be lost through being associated with a bad tender; that there is divided responsibility for the work; that an enormous amount of work is wasted in unaccepted schemes, the cost of which has to be recovered by an increased price for designing. Many other objections might also be enumerated.

Experience of works executed by a competent engineer using his own staff of foremen thoroughly trained to his designs and methods, shows that under this arrangement the full advantages of reinforced concrete constructions may be obtained without any danger arising from bad workmanship or want of understanding between drawing office and works.

APPENDIX I

BEING mathematical analyses of beams under various conditions of loading and fixing.

CONTENTS

Appendix No.	Subject.	PAGE
	List of Symbols	262
ONE SPAN.		
1.	Uniform load, slope at the ends given	263
2.	Load uniformly varying from zero at the ends to a maximum at the centre, slope at the ends given ...	266
3.	Concentrated load at midspan, slope at the ends given	267
4.	Two concentrated loads at the third points, slope at the ends given	270
5.	Uniform load, beam monolithic with columns	273
TWO SPANS.		
6.	Uniform load, beam not monolithic with columns ...	273
7.	Uniform load, beam monolithic with columns	274
THREE SPANS.		
8.	Uniform load, beam monolithic with columns	277
GENERAL CASE.		
9.	Any number of spans, uniform loads, spans and loads on different spans not necessarily equal	280
INTERIOR BAY OF BEAM OF MANY SPANS.		
Uniformly distributed load.		
10.	Maximum moment at the centre	283
11.	Maximum moment at the supports	284

Appendix No.	Subject.	PAGE
Load uniformly varying from zero at the ends to a maximum at the centre.		
12.	Maximum moment at the centre	286
13.	Maximum moment at the supports	287
Concentrated load at midspan.		
14.	Maximum moment at the centre	288
15.	Maximum moment at the supports	289
Two concentrated loads at third points.		
16.	Maximum moment at the centre	291
17.	Maximum moment at the supports	292
18.	BEAMS UNDER A LOAD UNIFORMLY VARYING FROM ZERO AT ONE END TO A MAXIMUM AT THE OTHER (as for reservoirs)	293
EFFECT OF SETTLEMENT OF SUPPORTS ON CENTRE MOMENTS OF CONTINUOUS BEAMS.		
19.	Many spans	296
20.	Two spans	298

SYMBOLS.

The various symbols used in this Appendix are collected here for reference.

w uniform load per unit length of beam.

l span of beam centre to centre of supports.

I moment of inertia of beam or column.

B ratio of moment of inertia to length for a beam.

C " " " " column.

K constant in equation $M = KCEa$.

a the slope with its original position at the end * of a member strained by bending.

R total reaction of a beam on a column.

x and y , horizontal and vertical co-ordinates of a point respectively.

X_1, X_2 , etc., constants of integration.

* *I.e.* a particular value of $\frac{dy}{dx}$. The slope is the tangent of the angle, but as the angles are always exceedingly small, $a = \tan a$ without sensible error.

Moments which cause tension in the top of the beam will be written negative.

$$\begin{aligned} S_1 &= K_1 C_1 + 4B_1 \\ S_2 &= K_2 C_2 + 4B_1 + 4B_2 \\ S_3 &= K_3 C_3 + 4B_2 + 4B_3, \text{ etc.} \end{aligned}$$

The slope will be considered positive when the beam has turned through a positive angle from its neutral position, that is, when it has turned in a counter-clockwise direction.

It has been assumed in all cases that the moment of inertia of the beams is constant throughout any particular span.

APPENDIX 1.

One span uniformly loaded, the ends having certain slopes α_1, α_2 (Fig. 135).

- To find (i) the negative moments at the supports,
 (ii) the reactions at the supports,
 (iii) the maximum value of the positive moment near the centre of the beam.



FIG. 135.—One span, uniformly loaded.

The equation to the bending moment at any point is

$$M = EI \frac{d^2 y}{dx^2} = R_1 x - \frac{wx^2}{2} + M_1.$$

Integrating,
$$EI \frac{dy}{dx} = \frac{R_1 x^2}{2} - \frac{wx^3}{6} + M_1 x + X_1.$$

When $x = 0$, $EI\alpha_1 = X_1$, and substituting this value,

$$EI \frac{dy}{dx} = \frac{R_1 x^2}{2} - \frac{wx^3}{6} + M_1 x + EI\alpha_1 \dots (1)$$

When $x = l$,
$$\frac{dy}{dx} = \alpha_2;$$

Therefore
$$EI\alpha_2 = \frac{R_1 l^2}{2} - \frac{wl^3}{6} + M_1 l + EI\alpha_1$$

$$M_1 = -\frac{R_1 l}{2} + \frac{wl^2}{6} - \frac{EI(\alpha_1 - \alpha_2)}{l} \dots (2)$$

Integrating equation (1),

$$EIy = \frac{R_1 x^3}{6} - \frac{wx^4}{24} + \frac{M_1 x^2}{2} + EI\alpha_1 x + X_2 \dots (3)$$

When $x = 0$, $y = 0$, and therefore $X_2 = 0$.

When $x = l$, $y = 0$. Substituting this value in (3) and rewriting,

$$M_1 = -\frac{R_1 l}{3} + \frac{wl^2}{12} - \frac{2EIa_1}{l} \quad \dots \quad (4)$$

Multiplying (2) by two and (4) by three and subtracting

$$M_1 = -\frac{wl^2}{12} - \frac{4EIa_1}{l} - \frac{2EIa_2}{l}$$

$$M_1 = -\frac{wl^2}{12} - 4EBa_1 - 2EBa_2.$$

Subtracting (4) from (2) and solving for R_1 ,

$$R_1 = \frac{wl}{2} + \frac{6EIa_1}{l^2} + \frac{6EIa_2}{l^2}$$

$$R_2 = wl - R_1 = \frac{wl}{2} - \frac{6EIa_1}{l^2} - \frac{6EIa_2}{l^2}.$$

Taking moments about the right-hand support,

$$M_2 = R_1 l - \frac{wl^2}{2} + M_1$$

and substituting the values given above for R_1 and M_1 ,

$$M_2 = -\frac{wl^2}{12} + \frac{2EIa_1}{l} + \frac{4EIa_2}{l}.$$

The maximum positive moment near the centre of the beam will occur at such a distance x from the left support that the shear is zero.

$$R_1 - wx = 0; \text{ therefore } x = \frac{R_1}{w}.$$

Substituting the value of R_1 given above,

$$x = \frac{l}{2} + \frac{6EI}{wl^2} (a_1 + a_2).$$

The moment at this point M_c ,

$$M_c = R_1 x - \frac{wx^2}{2} + M_1$$

$$M_c = \frac{R_1^2}{w} - \frac{R_1^2}{2w} + M_1 = \frac{R_1^2}{2w} + M_1.$$

These equations may, for clearness, be summarized as follows:—

$$M_1 = -\frac{wl^2}{12} - 4EBa_1 - 2EBa_2$$

$$M = -\frac{wl^2}{12} + 2EBa_1 + 4EBa_2$$

$$R_1 = \frac{wl}{2} + \frac{6EB}{l}(a_1 + a_2)$$

$$R = \frac{wl}{2} - \frac{6EB}{l}(a_1 + a_2)$$

$$M_c = \frac{R_1^2}{2w} + M_1.$$

These equations for M_1 , M_2 , etc., simplify for certain values of a_1 and a_2 .

Case I. When $a_1 = a_2$, that is, when the beam takes up the position shown in Fig. 136.

$$M_1 = -\frac{wl^2}{12} - 6EBa_1$$

$$M_2 = -\frac{wl^2}{12} + 6EBa_1.$$



FIG. 136.— $a_1 = a_2$.

Case II. When $a_1 = -a_2$ (Fig. 137).

$$M_1 = -\frac{wl^2}{12} - 2EBa_1$$

$$M_2 = -\frac{wl^2}{12} + 2EBa_1.$$



FIG. 137.— $a_1 = -a_2$.

Case III. When $a_2 = 0$ (Fig. 138).

$$M_1 = -\frac{wl^2}{12} - 4EBa_1$$

$$M_2 = -\frac{wl^2}{12} + 2EBa_1.$$

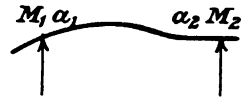

FIG. 138.— $a_2 = 0$.

Case IV. When $M_2 = 0$, that is, when one end of a beam is free, the moment at the other end being M_1 (Fig. 139).

$$M_1 = -\frac{wl^2}{12} - 4EBa_1 - 2EBa_2$$

$$M_2 = -\frac{wl^2}{12} + 2EBa_1 + 4EBa_2 = 0.$$



FIG. 139.— $M_2 = 0$.

Therefore $2EBa_2 = \frac{wl^2}{24} + EBa_1$.

Substituting this in the equation for M_1 ,

$$M_1 = -\frac{wl^2}{8} - 3EBa_1.$$

For this case

$$R = \frac{wl}{2} - \left(\frac{M_1 - M_2}{l} \right) = \frac{5}{8}wl + \frac{3EBa_1}{l}.$$

For columns the lateral load w will be zero, and if B is replaced by C , the general expression for the moment at one end may be written

$$M = KCEa,$$

in which K will vary from 2 to 6.

APPENDIX 2.

One span, load uniformly varying from zero at the ends to a maximum at the centre, given slopes α_1 and α_2 at the ends (Fig. 140).

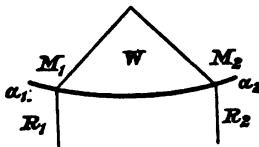

To find the value of the negative moments at the ends in terms of the load and the slopes at the ends.

FIG. 140.—One span, triangular loading.

If by W we signify the total load on the beam, the ordinate to the load

curve at any distance x from the left support will be $= \frac{4Wx}{l^2}$.

The equation to the bending moment at any point up to the centre of the beam is

$$M = EI \frac{d^2y}{dx^2} = M_1 + R_1x - \frac{4Wx}{l^2} \cdot \frac{x}{2} \cdot \frac{x}{3}.$$

Integrating this,

$$EI \frac{dy}{dx} = M_1x + \frac{R_1x^2}{2} - \frac{Wx^3}{6l^2} + X_1$$

and when $x = 0$

$$EI\alpha_1 = X_1$$

and substituting this value

$$EI \frac{dy}{dx} = M_1x + \frac{R_1x^2}{2} - \frac{Wx^3}{6l^2} + EI\alpha_1 \quad \dots (1)$$

Similarly, the slope at any point at a distance x from the right-hand support is given by

$$EI \frac{dy}{dx} = M_2 x + \frac{R_2 x^2}{2} - \frac{W x^3}{6l^2} - EI a_2 \dots (2)$$

Remembering that $R_2 = \frac{W}{2} + \left(\frac{M_1 - M_2}{l}\right)$, and putting $x = \frac{l}{2}$ in each of equations (1) and (2), equating the two values of $EI \frac{dy}{dx}$, and remembering that the slope obtained from (2) will be of opposite sign to that obtained from (1), we obtain

$$(M_1 + M_2) \frac{l}{2} + \frac{5}{48} W l^2 + EI(a_1 - a_2) = 0 \dots (3)$$

Integrating equation (1),

$$EI y = \frac{M_1 x^2}{2} + \frac{R_1 x^3}{6} - \frac{W x^4}{30l^2} + EI a_1 x + X_3$$

and since the deflection is zero when $x = 0$,

$$\text{therefore } X_3 = 0.$$

Integrating equation (2),

$$EI y = \frac{M_2 x^2}{2} + \frac{R_2 x^3}{6} - \frac{W x^4}{30l^2} - EI a_2 x + X_3$$

When $x = 0$, $y = 0$, and $X_3 = 0$, both deflections will be of the same sign. Equating the values obtained from the two equations when $x = \frac{l}{2}$, we get

$$\begin{aligned} \frac{(M_1 - M_2)l^2}{8} - \frac{l^3}{48} \cdot \frac{2(M_1 - M_2)}{l} + \frac{EI(a_1 + a_2)}{2} &= 0 \\ (M_1 - M_2) \frac{l^2}{12} + \frac{EI(a_1 + a_2)}{2} &= 0 \dots (4) \end{aligned}$$

From these two equations (3) and (4) the following expressions for M_1 and M_2 are obtained :—

$$M_1 = -\frac{5}{48} Wl - 4EBa_1 - 2EBa_2 \dots (5)$$

$$M_2 = -\frac{5}{48} Wl + 2EBa_2 + 4EBa_1 \dots (6)$$

APPENDIX 3.

One span, concentrated load W at the centre, given slopes a_1 and a_2 at the ends (Fig. 141).

To find the value of the negative moments at the supports.

The equation to the bending moment at any point in the beam up to the centre is

$$M = EI \frac{d^2y}{dx^2} = M_1 + R_1x.$$

Integrating this,

$$EI \frac{dy}{dx} = M_1x + \frac{R_1x^2}{2} + X_1.$$

When $x = 0$

$$EI\alpha_1 = X_1.$$

Substituting this value,

$$EI \frac{dy}{dx} = M_1x + \frac{R_1x^2}{2} + EI\alpha_1 \quad \dots \quad (1)$$

Beyond the centre,

$$M = EI \frac{d^2y}{dx^2} = M_1 + R_1x - W\left(x - \frac{l}{2}\right)$$

Integrating,

$$EI \frac{dy}{dx} = M_1x + \frac{R_1x^2}{2} - \frac{Wx^2}{2} + \frac{Wlx}{2} + X_2$$

when $x = l$,

$$EI\alpha_2 = M_1l + \frac{R_1l^2}{2} - \frac{Wl^2}{2} + \frac{Wl^2}{2} + X_2.$$

Substituting the value of X_2 from this equation, we get

$$EI \frac{dy}{dx} = M_1(x - l) + \frac{R_1}{2}(x^2 - l^2) - \frac{Wx^2}{2} + \frac{Wlx}{2} + EI\alpha_2. \quad (2)$$

At the centre of the beam the slope derived from either of equations (1) or (2), since they are both true, will be the same.

Substituting the value $x = \frac{l}{2}$ and equating the two values of

$EI \frac{dy}{dx}$ from equations (1) and (2), we get

$$\frac{M_1l}{2} + \frac{R_1l^2}{8} + EI\alpha_1 = -\frac{M_1l}{2} - \frac{3}{8}R_1l^2 - \frac{Wl^2}{8} + \frac{Wl^2}{4} + EI\alpha_2$$

$$\therefore M_1 = -\frac{R_1l}{2} + \frac{Wl}{8} - \frac{EI(\alpha_1 - \alpha_2)}{l} \quad \dots \quad (3)$$

Integrating equation (1),

$$EIy = \frac{M_1x^2}{2} + \frac{R_1x^3}{6} + EI\alpha_1x + X_3.$$

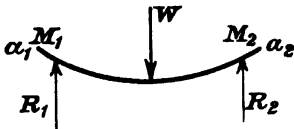

FIG. 141.—One span, with concentrated load at centre.

When $x = 0, y = 0$; and therefore $X_3 = 0$.

Hence
$$EIy = \frac{M_1x^3}{2} + \frac{R_1x^3}{6} + EIa_1x \dots \dots \dots (4)$$

Integrating equation (2),

$$EIy = \frac{M_1x^3}{2} - M_1lx + \frac{R_1x^3}{6} - \frac{R_1l^2x}{2} - \frac{Wx^3}{6} + \frac{Wlx^2}{4} + EIa_2x + X_4$$

When $x = l, y = 0$, and therefore

$$0 = \frac{M_1l^3}{2} - M_1l^2 + \frac{R_1l^3}{6} - \frac{R_1l^2}{2} - \frac{Wl^3}{6} + \frac{Wl^2}{4} + EIa_2l + X_4$$

Therefore
$$X_4 = \frac{M_1l^2}{2} + \frac{R_1l^2}{3} - \frac{Wl^2}{12} - EIa_2l,$$

and substituting this value, a second expression for EIy is obtained,

$$EIy = \frac{M_1x^3}{2} - M_1lx + \frac{M_1l^2}{2} + \frac{R_1x^3}{6} - \frac{R_1l^2x}{2} + \frac{R_1l^2}{3} - \frac{Wx^3}{6} + \frac{Wlx^2}{4} - \frac{Wl^2}{12} + EIa_2x - EIa_2l \dots \dots \dots (5)$$

The deflections y derived from either of equations (4) or (5) will be the same at the centre of the beam. We may therefore equate the two expressions for EIy if $x = \frac{l}{2}$ be substituted in each.

$$\begin{aligned} \frac{M_1l^2}{8} + \frac{R_1l^2}{48} + \frac{EIa_1l}{2} &= \frac{M_1l^2}{8} - \frac{M_1l^2}{2} + \frac{M_1l^2}{2} + \frac{R_1l^2}{48} - \frac{R_1l^2}{4} + \frac{R_1l^2}{3} - \frac{Wl^2}{48} \\ &+ \frac{Wl^2}{16} - \frac{Wl^2}{12} + \frac{EIa_2l}{2} - EIa_2l \end{aligned}$$

$$\therefore \frac{R_1l^2}{12} = \frac{Wl^2}{24} + \frac{EI}{2}(a_1 + a_2)$$

or
$$R_1 = \frac{W}{2} + \frac{6EI}{l^2}(a_1 + a_2) \dots \dots \dots (6)$$

To find the value of the negative moment at the support, we may substitute the value of R_1 from equation (6) in equation (3).

$$M_1 = -\frac{Wl}{8} - \frac{3EI(a_1 + a_2)}{l} - \frac{EI(a_1 - a_2)}{l} + \frac{Wl}{8}$$

$$M_1 = -\frac{Wl}{8} - 4EBa_1 - 2EBa_2 \dots \dots \dots (7)$$

and
$$M_2 = -\frac{Wl}{8} + 4EBa_2 + 2EBa_1 \dots \dots \dots (8)$$

When the slopes α_1 and α_2 are equal but of opposite sign,

$$M_1 = -\frac{Wl}{8} - 2EB\alpha_1$$

$$M_2 = -\frac{Wl}{8} + 2EB\alpha_2$$

APPENDIX 4.

One span, two concentrated loads of $\frac{W}{2}$ at the third points, given slopes α_1 and α_2 at the ends (Fig. 142).

To find the value of the negative moment at the supports.

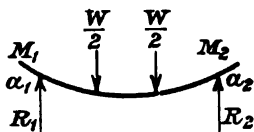

FIG. 142.—One span, two concentrated loads at the third points.

The equation to the bending moment at any point in the beam up to the first load is

$$M = EI \frac{d^2y}{dx^2} = M_1 + R_1x.$$

Integrating this,

$$EI \frac{dy}{dx} = M_1x + \frac{R_1x^2}{2} + X_1.$$

When $x = 0$,

$$EI\alpha_1 = X_1.$$

Substituting this value,

$$EI \frac{dy}{dx} = M_1x + \frac{R_1x^2}{2} + EI\alpha_1 \dots \dots \dots (1)$$

Between the first and second loads, the equation to the bending moment at any point is

$$M = EI \frac{d^2y}{dx^2} = M_1 + R_1x - \frac{W}{2} \left(x - \frac{l}{3} \right)$$

Integrating this,

$$EI \frac{dy}{dx} = M_1x + \frac{R_1x^2}{2} - \frac{Wx^2}{4} + \frac{Wlx}{6} + X_2 \dots \dots (2)$$

When $x = l/3$ is substituted in both, this equation should give the same value of $\frac{dy}{dx}$ as equation (1).

Substituting $x = \frac{l}{3}$ in (1) and (2) and equating,

$$\frac{M_1 l}{3} + \frac{R_1 l^2}{18} + EI a_1 = \frac{M_1 l}{3} + \frac{R_1 l^2}{18} - \frac{W l^2}{36} + \frac{W l^2}{18} + X_2$$

whence
$$X_2 = EI a_1 - \frac{W l^2}{36}.$$

Putting this in equation (2),

$$EI \frac{dy}{dx} = M_1 x + \frac{R_1 x^2}{2} - \frac{W x^2}{4} + \frac{W l x}{6} + EI a_1 - \frac{W l^2}{36}. \quad (3)$$

Between the second load and the right-hand support, the equation to the bending moment at any point is

$$M = EI \frac{d^2 y}{dx^2} = M_1 + R_1 x - \frac{W}{2} \left(x - \frac{l}{3} \right) - \frac{W}{2} \left(x - \frac{2l}{3} \right).$$

Integrating this,

$$EI \frac{dy}{dx} = M_1 x + \frac{R_1 x^2}{2} - \frac{W x^2}{4} + \frac{W l x}{6} - \frac{W x^2}{4} + \frac{W l x}{3} + X_3.$$

When $x = l$,
$$\frac{dy}{dx} = a_2.$$

Hence
$$EI a_2 = M_1 l + \frac{R_1 l^2}{2} - \frac{W l^2}{2} + \frac{W l^2}{2} + X_3$$

or
$$X_3 = EI a_2 - M_1 l - \frac{R_1 l^2}{2}$$

$$\therefore EI \frac{dy}{dx} = M_1 x + \frac{R_1 x^2}{2} - \frac{W x^2}{2} + \frac{W l x}{2} + EI a_2 - M_1 l - \frac{R_1 l^2}{2} \quad (4)$$

The values of $\frac{dy}{dx}$ given by equations (3) or (4) will be identical for a value of $x = \frac{2l}{3}$. Hence, by making this substitution and equating the two results,

$$-\frac{W l^2}{9} + \frac{W l^2}{9} + EI a_1 - \frac{W l^2}{36} = -\frac{2}{9} W l^2 + \frac{W l^2}{3} + EI a_2 - M_1 l - \frac{R_1 l^2}{2}$$

$$M_1 = \frac{5}{36} W l - \frac{EI(a_1 - a_2)}{l} - \frac{R_1 l}{2}.$$

Integrating equation (1), and remembering that since $y = 0$ when $x = 0$, the constant of integration will be zero,

$$EI y = \frac{M_1 x^2}{2} + \frac{R_1 x^3}{6} + EI a_1 x \quad \dots \quad (5)$$

Integrating equation (3),

$$EIy = \frac{M_1 x^2}{2} + \frac{R_1 x^3}{6} - \frac{W x^3}{12} + \frac{W l x^3}{12} + EI a_1 x - \frac{W l^2 x}{36} + X_4. \quad (6)$$

To find the value of X_4 we must substitute the value $x = l/3$ in both these equations (5) and (6), and equate the values of y obtained in each case.

$$0 = -\frac{W l^3}{12 \times 27} + \frac{W l^3}{12 \times 9} - \frac{W l^3}{3 \times 36} + X_4.$$

$$X_4 = \frac{W l^3}{324}.$$

Rewriting equation (6), we obtain

$$EIy = \frac{M_1 x^2}{2} + \frac{R_1 x^3}{6} - \frac{W x^3}{12} + \frac{W l x^3}{12} + EI a_1 x - \frac{W l^2 x}{36} + \frac{W l^3}{324} \quad (7)$$

Integrating equation (4),

$$EIy = \frac{M_1 x^2}{2} + \frac{R_1 x^3}{6} - \frac{W x^3}{6} + \frac{W l x^3}{4} + EI a_2 x - M_1 l x - \frac{R_1 l^2 x}{2} + X_5. \quad (8)$$

Substituting the value $x = \frac{2}{3}l$ in equations (7) and (8), we obtain

$$-\frac{W l^3 \times 8}{12 \times 27} + \frac{W l^3}{27} + EI a_1 \frac{2l}{3} - \frac{W l^3}{54} + \frac{W l^3}{324}$$

$$= -W l^3 \cdot \frac{4}{81} + \frac{W l^3}{9} + EI a_2 \cdot \frac{2}{3}l - \frac{2}{3}M_1 l^2 - \frac{R_1 l}{3} + X_5$$

$$X_5 = -\frac{7}{108}W l^3 + EI \cdot \frac{2}{3}l(a_1 - a_2) + \frac{2}{3}M_1 l^2 + \frac{R_1 l^2}{3}.$$

Substituting this value of X_5 in equation (8) and putting $x = l$, in which case $y = 0$,

$$0 = \frac{M_1 l^2}{2} + \frac{R_1 l^2}{6} - \frac{W l^2}{6} + \frac{W l^2}{4} + EI a_2 l - M_1 l^2 - \frac{R_1 l^2}{2} - \frac{7W l^2}{108}$$

$$+ \frac{2}{3}EI l(a_1 - a_2) + \frac{2}{3}M_1 l^2 + \frac{R_1 l^2}{3}.$$

$$M_1 = -\frac{1}{9}W l - 4EB a_1 - 2EB a_2,$$

which is the equation to the negative moment at the support.

APPENDIX 5.

One span uniformly loaded monolithic with columns (Fig. 143).

(i) To find the slope at the ends of the beam.

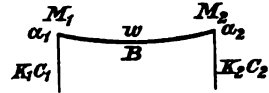

FIG. 143.—One span uniformly loaded, monolithic with columns.

From the data given in Appendix 1, we may write down the four following equations:—

$$M_1 = K_1 C_1 E a_1 \dots \dots \dots (1)$$

$$M_1 = -\frac{w l^2}{12} - 4 E B a_1 - 2 E B a_2 \dots \dots \dots (2)$$

$$M_2 = -\frac{w l^2}{12} + 4 E B a_2 + 2 E B a_1 \dots \dots \dots (3)$$

$$M_2 = -K_2 C_2 E a_2 \dots \dots \dots (4)$$

Equating the values of M_2 , we get

$$-K_2 C_2 E a_2 = -\frac{w l^2}{12} + 4 E B a_2 + 2 E B a_1$$

or
$$E a_2 = \frac{w l^2}{12} \cdot \frac{1}{(K_2 C_2 + 4 B)} - \frac{2 B}{(K_2 C_2 + 4 B)} E a_1.$$

Equating the values of M_1 ,

$$\begin{aligned} E a_1 &= -\frac{w l^2}{12} \cdot \frac{1}{(K_1 C_1 + 4 B)} - \frac{2 B}{(K_1 C_1 + 4 B)} E a_2 \\ &= \frac{-\frac{w l^2}{12} \left\{ 1 + \frac{2 B}{(K_2 C_2 + 4 B)} \right\}}{(K_1 C_1 + 4 B) - \frac{4 B^2}{K_2 C_2 + 4 B}} \end{aligned}$$

If, as is generally the case, $K_1 C_1 = K_2 C_2$

$$E a_1 = -\frac{w l^2}{12} \cdot \frac{1}{(K C + 2 B)}$$

APPENDIX 6.

Two equal spans, beam resting freely on supports, uniformly loaded with w_1 on one span and w_2 on the other (Fig. 144).

To find (i) the moment at the centre support,

(ii) the slope of the beam over the centre support,

(iii) the magnitude of the reactions.

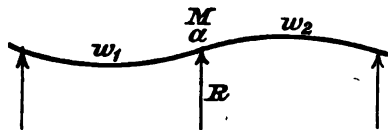

FIG. 144.—Two equal spans, freely supported, each with its uniform load.

By means of equations in Appendix 1, two expressions may be obtained for the moment M , one from each span.

Equating these,

$$M = -\frac{w_1 l^2}{8} + 3EBa = -\frac{w_2 l^2}{8} - 3EBa$$

$$6EBa = (w_1 - w_2) \frac{l^2}{8}$$

whence
$$M = -\frac{w_1 l^2}{8} + \frac{(w_1 - w_2)}{2} \cdot \frac{l^2}{8} = -\frac{(w_1 + w_2) l^2}{16}$$

Now
$$a = \frac{(w_1 - w_2) l^2}{48BE} = \frac{(w_1 - w_2) l^2}{48IE}$$

and the total reaction on the centre column

$$R = \frac{5}{8} w_1 l - \frac{3EBa}{l} + \frac{5}{8} w_2 l + \frac{3EBa}{l}$$

$$= \frac{5}{8} l (w_1 + w_2).$$

Summarizing these results—

- (i) $M = -\frac{(w_1 + w_2) l^2}{16}$
- (ii) $a = \frac{(w_1 - w_2) l^2}{48EI}$
- (iii) $R = \frac{5(w_1 + w_2) l}{8}$.

APPENDIX 7.

Two spans monolithic with columns, uniformly loaded with w_1 on one span and w_2 on the other (Fig. 145).

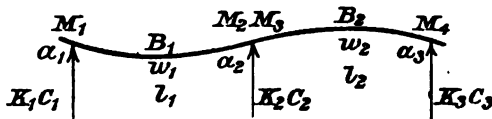

FIG. 145.—Two spans, monolithic with the columns, each with its uniform load.

- To find (i) the slope of the beam at the outer support,
 (ii) the slope of the beam at the central support.

From the data given in Appendix I. 1, it is possible to write down the seven following equations:—

$$M_1 = K_1 C_1 E a_1 \dots \dots \dots (1)$$

$$= -\frac{w_1 l_1^2}{12} - 4EB_1 a_1 - 2EB_1 a_2 \dots \dots (2)$$

$$M_2 = -\frac{w_1 l_1^3}{12} + 2EB_1 a_1 + 4EB_1 a_2 \dots (3)$$

$$= M_3 - K_2 C_2 E a_2 \dots (4)$$

$$M_3 = -\frac{w_2 l_2^3}{12} - 4EB_2 a_2 - 2EB_2 a_3 \dots (5)$$

$$M_4 = -\frac{w_2 l_2^3}{12} + 2EB_2 a_2 + 4EB_2 a_3 \dots (6)$$

$$= -K_3 C_3 E a_3 \dots (7)$$

From (1) and (2),

$$2EB_1 a_2 = -\frac{w_1 l_1^3}{12} - E a_1 (K_1 C_1 + 4B_1) \dots (8)$$

Substituting (5) in (4), and equating to (3),

$$2EB_2 a_3 = \frac{w_1 l_1^3}{12} - \frac{w_2 l_2^3}{12} - E a_2 (K_2 C_2 + 4B_1 + 4B_2) - 2EB_1 a_1 \dots (9)$$

From (6) and (7),

$$0 = \frac{w_2 l_2^3}{12} - E a_3 (K_3 C_3 + 4B_2) - 2EB_2 a_2 \dots (10)$$

From (10),

$$E a_3 = \frac{w_2 l_2^3}{12} \left(\frac{1}{K_3 C_3 + 4B_2} \right) - 2EB_2 a_2 \left(\frac{1}{K_3 C_3 + 4B_2} \right)$$

Substituting this value of $E a_3$ in (9) and collecting like terms,

$$\begin{aligned} E a_2 \left\{ (K_2 C_2 + 4B_1 + 4B_2) - \frac{4B_2^2}{(K_3 C_3 + 4B_2)} \right\} \\ = \frac{w_1 l_1^3}{12} - \frac{w_2 l_2^3}{12} \left\{ 1 + \frac{2B_2}{(K_3 C_3 + 4B_2)} \right\} - 2EB_1 a_1 \end{aligned}$$

Substituting this value of $E a_2$ in equation (8) and collecting like terms,

$$\begin{aligned} E a_1 \left[(K_1 C_1 + 4B_1) - \frac{4B_1^2}{\left\{ (K_2 C_2 + 4B_1 + 4B_2) - \frac{4B_2^2}{(K_3 C_3 + 4B_2)} \right\}} \right] \\ = -\frac{w_1 l_1^3}{12} \left[1 + \frac{2B_1}{\left\{ (K_2 C_2 + 4B_1 + 4B_2) - \frac{4B_2^2}{(K_3 C_3 + 4B_2)} \right\}} \right] \\ + \frac{w_2 l_2^3}{12} \left\{ 1 + \frac{2B_2}{(K_3 C_3 + 4B_2)} \right\} \left[\frac{2B_1}{\left\{ (K_2 C_2 + 4B_1 + 4B_2) - \frac{4B_2^2}{(K_3 C_3 + 4B_2)} \right\}} \right] \end{aligned}$$

In the general case it is convenient to substitute

$$S_1 = (K_1 C_1 + 4B_1),$$

$$S_2 = (K_2 C_2 + 4B_1 + 4B_2),$$

$$S_3 = (K_2 C_2 + 4B_2 + 4B_3), \text{ etc., } B_3 \text{ in this case being zero.}$$

The expression given above may therefore be rewritten

$$Ea_1 \left(S_1 - \frac{4B_1^2}{S_2 - \frac{4B_2^2}{S_3}} \right) = -\frac{w_1 l_1^2}{12} \left(1 + \frac{2B_1}{S_2 + \frac{4B_2^2}{S_3}} \right) + \frac{w_2 l_2^2}{12} \left(1 + \frac{2B_2}{S_3} \right) \left(\frac{2B_1}{S_2 - \frac{4B_2^2}{S_3}} \right).$$

And Ea_2 may be calculated from equation (8).

When the two outside columns are similar, and the spans and moments of inertia of the two parts of the beam are equal,

$$K_2 C_2 = K_1 C_1 \text{ and } B_2 = B_1.$$

$$Ea_1 = -\frac{w_1 l^2}{12} \left[\frac{(K_1 C_1 + 4B)(K_2 C_2 + 10B) - 4B^2}{(K_1 C_1 + 4B)\{(K_1 C_1 + 4B)(K_2 C_2 + 8B) - 8B^2\}} \right] + \frac{w_2 l^2}{12} \left[\frac{2B(K_1 C_1 + 6B)}{(K_1 C_1 + 4B)\{(K_1 C_1 + 4B)(K_2 C_2 + 8B) - 8B^2\}} \right]$$

$$\text{and } Ea_2 = +\frac{w_1 l^2}{12} \left\{ \frac{K_1 C_1 + 6B}{(K_1 C_1 + 4B)(K_2 C_2 + 8B) - 8B^2} \right\} - \frac{w_2 l^2}{12} \left\{ \frac{K_1 C_1 + 6B}{(K_1 C_1 + 4B)(K_2 C_2 + 8B) - 8B^2} \right\}.$$

When the moment of inertia of the centre column is twice that of the outer ones,

$$K_2 C_2 = 2K_1 C_1,$$

and substituting this value, we get

$$(i) \quad Ea_1 = -\frac{l^2}{12} \left\{ \frac{w_1(K_1 C_1 + 3B) - w_2 B}{(K_1 C_1 + 4B)(K_1 C_1 + 2B)} \right\}.$$

When the two outer columns are replaced by walls, $K_1 C_1$ becomes zero, and the slope of the beam over the centre support

$$(ii) \quad Ea_2 = \frac{(w_1 - w_2)l^2}{8(K_2 C_2 + 6B)}.$$

It may be noted for the latter case that the reaction of the beam on the centre column is independent of the stiffness of the column. Numbering the reactions 1, 2, 3, from left to right, we have

$$M_2 = -\frac{w_1 l^3}{8} + 3ECa_2 \quad (\text{Appendix 1})$$

and
$$M_3 = R_1 l - \frac{w_1 l^3}{2}.$$

Therefore
$$R_1 = \frac{3}{8}w_1 l^2 + \frac{3ECa_2}{l}$$

and
$$R_3 = \frac{3}{8}w_2 l^2 - \frac{3ECa_2}{l}.$$

Hence the total reaction on the central column R_2

$$\begin{aligned} R_2 &= w_1 l - R_1 + w_2 l - R_3 \\ &= \frac{5}{8}l(w_1 + w_2). \end{aligned}$$

APPENDIX 8.

Three spans loaded with $w_1, w_2,$ and w_3 on the first, second, and third spans respectively (Fig. 146), the beams and columns being symmetrical about the centre line of the centre beam.



FIG. 146.—Three spans, each with its uniform load.

To find (i) Ea_2 when

K_1C_1 is zero, or, in other words, when the outside columns are replaced by walls,

(a) when $B_1 = B_2$, (b) when $B_1 = 1.25B_2$.

(ii) Ea_1 when $B_1 = B_2$ and $K_2C_2 = K_1C_1$.

(iii) Ea_1 when $B_1 = B_2$ and $K_2C_2 = 2K_1C_1$.

We may derive an expression for Ea_1 from the general equation given in Appendix 9. Before writing down this expression it will be convenient first to find the values of the individual terms in brackets. Remembering that since the beam was assumed symmetrical,

$$S_1 = S_4 = K_1C_1 + 4B_1$$

$$S_2 = S_3 = K_2C_2 + 4B_1 + 4B_2$$

and $B_1 = B_2$

$$\left(S_2 - \frac{4B_2^2}{S_4}\right) = \frac{S_1S_2 - 4B_1^2}{S_1}$$

$$\left(S_2 - \frac{4B_2^2}{S_3 - \frac{4B_2^2}{S_4}}\right) = \frac{S_2(S_1S_2 - 4B_1^2) - 4S_1B_2^2}{S_1S_2 - 4B_1^2}$$

$$\left(S_1 - \frac{4B_1^2}{S_2 - \frac{4B_2^2}{S_2 - \frac{4B_3^2}{S_4}}} \right) = \frac{(S_1 S_2 - 4B_1^2)(S_1 S_2 - 4B_2^2) - 4S_1^2 B_2^2}{S_2(S_1 S_2 - 4B_1^2) - 4S_1 B_2^2}$$

The coefficient of $-\frac{w_1 l_1^2}{12}$ is

$$\frac{(S_1 S_2 - 4B_1^2)(S_2 + 2B_1) - 4S_1 B_2^2}{(S_1 S_2 - 4B_1^2)(S_1 S_2 - 4B_2^2) - 4S_1^2 B_2^2}$$

The coefficient of $+\frac{w_2 l_2^2}{12}$ is

$$\frac{2B_1 \{(S_1 S_2 - 4B_1^2) + 2S_1 B_1\}}{(S_1 S_2 - 4B_1^2)(S_1 S_2 - 4B_2^2) - 4S_1^2 B_2^2}$$

The coefficient of $-\frac{w_3 l_3^2}{12}$ is

$$\frac{4B_1 B_2 (S_1 + 2B_1)}{(S_1 S_2 - 4B_1^2)(S_1 S_2 - 4B_2^2) - 4S_1^2 B_2^2}$$

It may be noticed that these three coefficients have a common denominator.

(i) To find Ea_2 when $K_1 C_1 = 0$.

(a) When $B_1 = B_2$.

In this case $S_1 = 4B$,

$$S_2 = KC + 8B.$$

Substituting the values of S_1 and S_2 given above in the total expression for Ea_1 , we get

$$Ea_1 = -\frac{w_1 l_1^2}{12} \cdot \frac{1}{4B} \cdot \frac{(KC + 11B)(KC + 6B)}{(KC + 5B)(KC + 9B)} + \frac{w_2 l_2^2}{12} \cdot \frac{1}{2} \cdot \frac{1}{(KC + 5B)} - \frac{w_3 l_3^2}{12} \cdot \frac{3B}{2} \cdot \frac{1}{(KC + 5B)(KC + 9B)}$$

From Appendix 9,

$$Ea_2 = -\frac{1}{2B_1} \left(\frac{w_1 l_1^2}{12} + S_1 E a_1 \right).$$

Substituting for S_1 ,

$$\therefore Ea_2 = -\frac{1}{2B} \left(\frac{w_1 l_1^2}{12} + 4B E a_1 \right) = -\frac{w_1 l_1^2}{24B} - 2E a_1,$$

and substituting the value of Ea_1 given above, in this expression

$$Ea_2 = \frac{w_1 l_1^2}{12} \cdot \frac{3}{2} \cdot \frac{(KC + 7B)}{(KC + 5B)(KC + 9B)} - \frac{w_2 l_2^2}{12} \cdot \frac{1}{(KC + 5B)} + \frac{w_3 l_3^2}{12} \cdot \frac{3B}{(KC + 5B)(KC + 9B)}$$

When $w_1 = w_2 = w_3$,

$$Ea_2 = + \frac{w_1^2}{12} \cdot \frac{1}{2} \cdot \frac{1}{(KC + 5B)}.$$

When $w_1 = w_3$,

$$Ea_2 = \frac{l^2}{12} \cdot \frac{(1.5w_1 - w_2)}{(KC + 5B)}.$$

When $w_1 = w_2$,

$$Ea_2 = \frac{l^2}{12} \left\{ \frac{0.5(KC + 3B)w_1 + 3Bw_3}{(KC + 5B)(KC + 9B)} \right\}.$$

When $w_2 = w_3$,

$$Ea_2 = \frac{l^2}{12} \left\{ \frac{3(KC + 7B)w_1 - 2(KC + 6B)w_3}{2(KC + 5B)(KC + 9B)} \right\}.$$

(b) When $B_1 = 1.25B_2$,

$$S_1 = 5B_2 \text{ and}$$

$$S_2 = KC + 9B_2.$$

Substituting these values in the total expression for Ea_1 given previously, we get

$$Ea_1 = - \frac{w_1^2}{12} \cdot \frac{1}{5B} \cdot \frac{(K^2C^2 + 19.25KCB + 85.125B^2)}{(KC + 9.75B)(KC + 5.75B)} \\ + \frac{w_2^2}{12} \cdot \frac{1}{2} \cdot \frac{1}{(KC + 5.75B)} - \frac{3B}{2} \cdot \frac{w_3^2}{12} \cdot \frac{1}{(KC + 9.75B)(KC + 5.75B)}.$$

And as before,

$$Ea_2 = \frac{w_1^2}{12} \cdot \frac{3}{2} \cdot \frac{(KC + 7.75B)}{(KC + 5.75B)(KC + 9.75B)} - \frac{w_2^2}{12} \cdot \frac{1}{(KC + 5.75B)} \\ + \frac{w_3^2}{12} \cdot \frac{3B}{(KC + 5.75B)(KC + 9.75B)}.$$

When $w_1 = w_2 = w_3$,

$$Ea_2 = \frac{w_1^2}{12} \cdot \frac{1}{2} \cdot \frac{1}{(KC + 5.75B)}.$$

When $w_1 = w_3$,

$$Ea_2 = \frac{l^2}{12} \cdot \frac{1.5w_1 - w_2}{(KC + 5.75B)}.$$

When $w_1 = w_2$,

$$Ea_2 = \frac{l^2}{12} \left\{ \frac{0.5(KC + 3.75B)w_1 + 3Bw_3}{(KC + 9.75B)(KC + 5.75B)} \right\}.$$

When $w_2 = w_3$,

$$Ea_2 = \frac{l^2}{12} \left\{ \frac{3(KC + 7.75B)w_1 - 2(KC + 6.75B)w_3}{2(KC + 9.75B)(KC + 5.75B)} \right\}.$$

$$\left(S_1 - \frac{4B_2^2}{S_2 - \frac{4B_2^2}{S_3 - \frac{4B_2^2}{S_4}}} \right) = \frac{(S_1 S_2 - 4B_1^2)(S_1 S_3 - 4B_2^2) - 4S_1^2 B_2^2}{S_2(S_1 S_3 - 4B_1^2) - 4S_1 B_2^2}$$

The coefficient of $-\frac{w_1 l_1^2}{12}$ is

$$\frac{(S_1 S_2 - 4B_1^2)(S_2 + 2B_1) - 4S_1 B_2^2}{(S_1 S_2 - 4B_1^2)(S_1 S_3 - 4B_2^2) - 4S_1^2 B_2^2}$$

The coefficient of $+\frac{w_2 l_2^2}{12}$ is

$$\frac{2B_1\{(S_1 S_2 - 4B_1^2) + 2S_1 B_1\}}{(S_1 S_2 - 4B_1^2)(S_1 S_3 - 4B_2^2) - 4S_1^2 B_2^2}$$

The coefficient of $-\frac{w_3 l_3^2}{12}$ is

$$\frac{4B_1 B_2 (S_1 + 2B_1)}{(S_1 S_2 - 4B_1^2)(S_1 S_3 - 4B_2^2) - 4S_1^2 B_2^2}$$

It may be noticed that these three coefficients have a common denominator.

(i) To find Ea_2 when $K_1 C_1 = 0$.

(a) When $B_1 = B_2$.

In this case $S_1 = 4B$,

$$S_2 = KC + 8B.$$

Substituting the values of S_1 and S_2 given above in the total expression for Ea_1 , we get

$$Ea_1 = -\frac{w_1 l_1^2}{12} \cdot \frac{1}{4B} \cdot \frac{(KC + 11B)(KC + 6B)}{(KC + 5B)(KC + 9B)} + \frac{w_2 l_2^2}{12} \cdot \frac{1}{2} \cdot \frac{1}{(KC + 5B)} - \frac{w_3 l_3^2}{12} \cdot \frac{3B}{2} \cdot \frac{1}{(KC + 5B)(KC + 9B)}$$

From Appendix 9,

$$Ea_2 = -\frac{1}{2B_1} \left(\frac{w_1 l_1^2}{12} + S_1 Ea_1 \right).$$

Substituting for S_1 ,

$$\therefore Ea_2 = -\frac{1}{2B} \left(\frac{w_1 l_1^2}{12} + 4BEa_1 \right) = -\frac{w_1 l_1^2}{24B} - 2Ea_1,$$

and substituting the value of Ea_1 given above, in this expression

$$Ea_2 = \frac{w_1 l_1^2}{12} \cdot \frac{3}{2} \cdot \frac{(KC + 7B)}{(KC + 5B)(KC + 9B)} - \frac{w_2 l_2^2}{12} \cdot \frac{1}{(KC + 5B)} + \frac{w_3 l_3^2}{12} \cdot \frac{3B}{(KC + 5B)(KC + 9B)}$$

When $w_1 = w_2 = w_3$,

$$Ea_2 = + \frac{wl^2}{12} \cdot \frac{1}{2} \cdot \frac{1}{(KC + 5B)}$$

When $w_1 = w_3$,

$$Ea_2 = \frac{l^2}{12} \cdot \frac{(1.5w_1 - w_2)}{(KC + 5B)}$$

When $w_1 = w_2$,

$$Ea_2 = \frac{l^2}{12} \left\{ \frac{0.5(KC + 3B)w_1 + 3Bw_2}{(KC + 5B)(KC + 9B)} \right\}$$

When $w_2 = w_3$,

$$Ea_2 = \frac{l^2}{12} \left\{ \frac{3(KC + 7B)w_1 - 2(KC + 6B)w_2}{2(KC + 5B)(KC + 9B)} \right\}$$

(b) When $B_1 = 1.25B_2$,

$$S_1 = 5B_2 \text{ and}$$

$$S_2 = KC + 9B_2.$$

Substituting these values in the total expression for Ea_1 given previously, we get

$$Ea_1 = - \frac{w_1 l^2}{12} \cdot \frac{1}{5B} \cdot \frac{(K^2C^2 + 19.25KCB + 85.125B^2)}{(KC + 9.75B)(KC + 5.75B)} \\ + \frac{w_2 l^2}{12} \cdot \frac{1}{2} \cdot \frac{1}{(KC + 5.75B)} - \frac{3B}{2} \cdot \frac{w_2 l^2}{12} \cdot \frac{1}{(KC + 9.75B)(KC + 5.75B)}$$

And as before,

$$Ea_2 = \frac{w_1 l^2}{12} \cdot \frac{3}{2} \cdot \frac{(KC + 7.75B)}{(KC + 5.75B)(KC + 9.75B)} - \frac{w_2 l^2}{12} \cdot \frac{1}{(KC + 5.75B)} \\ + \frac{w_2 l^2}{12} \cdot \frac{3B}{(KC + 5.75B)(KC + 9.75B)}$$

When $w_1 = w_2 = w_3$,

$$Ea_2 = \frac{wl^2}{12} \cdot \frac{1}{2} \cdot \frac{1}{(KC + 5.75B)}$$

When $w_1 = w_3$,

$$Ea_2 = \frac{l^2}{12} \cdot \frac{1.5w_1 - w_2}{(KC + 5.75B)}$$

When $w_1 = w_2$,

$$Ea_2 = \frac{l^2}{12} \left\{ \frac{0.5(KC + 3.75B)w_1 + 3Bw_2}{(KC + 9.75B)(KC + 5.75B)} \right\}$$

When $w_2 = w_3$,

$$Ea_2 = \frac{l^2}{12} \left\{ \frac{3(KC + 7.75B)w_1 - 2(KC + 6.75B)w_2}{2(KC + 9.75B)(KC + 5.75B)} \right\}$$

(ii) To find the value of Ea_1 when $B_1 = B_2$ and $K_2C_2 = K_1C_1$.

For this case $S_1 = K_1C_1 + 4B$

$$S_2 = K_1C_1 + 8B.$$

The only case which need be considered is when the two outer bays are live loaded, and for this condition $w_1 = w_3$.

Simplifying the total expression for Ea_1 when $B_1 = B_2$,

$$\begin{aligned} Ea_1 &= -\frac{l^3}{12} \left[\frac{w_1 \{ (S_1S_2 - 4B^2)(S_2 + 2B) - 4S_1B^2 + 4B^2S_1 + 8B^3 \}}{(S_1S_2 - 4B^2 + 2S_1B)(S_1S_2 - 4B^2 - 2S_1B)} - w_2 \{ 2B(S_1S_2 + 2BS_1 - 4B^2) \}} \right] \\ &= -\frac{l^3}{12} \left\{ \frac{(w_1S_2 - 2Bw_2)(S_1S_2 + 2BS_1 - 4B^2)}{(S_1S_2 - 4B^2 + 2S_1B)(S_1S_2 - 4B^2 - 2S_1B)} \right\} \\ &= -\frac{l^3}{12} \left\{ \frac{w_1(KC + 8B) - 2w_2B}{K^2C^2 + 10KCB + 20B^2} \right\}. \end{aligned}$$

(iii) To find the value of Ea_1 when $B_1 = B_2$ and $K_2C_2 = 2K_1C_1$.*

For this case $S_1 = K_1C_1 + 4B$

$$S_2 = 2K_1C_1 + 8B = 2S_1.$$

Substituting these values of S_1 and S_2 in (ii),

$$Ea_1 = -\frac{l^3}{12} \left\{ \frac{w_1(K_1C_1 + 4B) - Bw_2}{(KC + 2B)(KC + 5B)} \right\}.$$

APPENDIX 9.

General case of a number of spans uniformly loaded with w_1, w_2, w_3 , etc., on the corresponding spans.

To find an expression for the slope at one end.

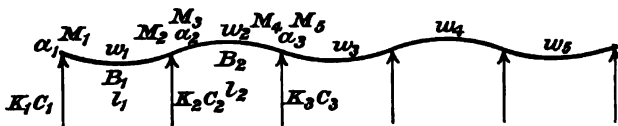

FIG. 147.—A number of spans, each with its uniform load.

The terms in the expressions become so cumbersome that it has been thought advisable to derive the expression for Ea_1 for a beam of five spans, from which, by writing it in the form of a series, the expression for Ea_1 for a beam of an infinite number of spans may be inferred.

From the data given in Appendix 1 it is possible to write down sixteen equations from which the sixteen unknowns may be found.

* N.B.—The numbering of K_1C_1 , etc., is as on Fig. 146.

$$M_1 = E a_1 K_1 C_1 (1)$$

$$M_1 = -\frac{w_1 l_1^3}{12} - 4EB_1 a_1 - 2EB_1 a_2 (2)$$

$$M_2 = -\frac{w_1 l_1^3}{12} + 2EB_1 a_1 + 4EB_1 a_2 (3)$$

$$M_2 = M_2 - E a_2 K_2 C_2 (4)$$

$$M_2 = -\frac{w_2 l_2^3}{12} - 4EB_2 a_2 - 2EB_2 a_3, \text{ and so on. } (5)$$

$$M_{10} = E a_6 K_6 C_6 (16)$$

Equating (1) and (2) we obtain the expression for $E a_1$,

$$2B_1 E a_2 = -\left\{ \frac{w_1 l_1^3}{12} + E a_1 (K_1 C_1 + 4B_1) \right\}.$$

From equations (3), (4), and (5),

$$-\frac{w_2 l_2^3}{12} - 4EB_2 a_2 - 2EB_2 a_3 = -\frac{w_1 l_1^3}{12} + 2EB_1 a_1 + 4EB_1 a_2 + K_2 C_2 E a_2$$

$$2EB_2 a_3 = \frac{w_1 l_1^3}{12} - \frac{w_2 l_2^3}{12} - E a_2 (K_2 C_2 + 4B_1 + 4B_2) - 2EB_1 a_1.$$

Owing to the frequent recurrence of terms similar to that in brackets, it is convenient to replace these by the letter S. Thus—

$$\begin{aligned} S_1 &= K_1 C_1 + 4B_1, \\ S_2 &= K_2 C_2 + 4B_1 + 4B_2, \\ S_3 &= K_3 C_3 + 4B_2 + 4B_3, \text{ and so on,} \\ S_6 &= K_6 C_6 + 4B_5. \end{aligned}$$

We may then write down six similar equations derived as above.

From (1) and (2) $2EB_1 a_2 = -\frac{w_1 l_1^3}{12} - E a_1 S_1 (17)$

(3), (4), and (5) $2EB_2 a_3 = \frac{w_1 l_1^3}{12} - \frac{w_2 l_2^3}{12} - E a_2 S_2 - 2EB_1 a_1. (18)$

(6), (7), and (8) $2EB_3 a_4 = \frac{w_2 l_2^3}{12} - \frac{w_3 l_3^3}{12} - E a_3 S_3 - 2EB_2 a_2. (19)$

(9), (10), and (11) $2EB_4 a_5 = \frac{w_3 l_3^3}{12} - \frac{w_4 l_4^3}{12} - E a_4 S_4 - 2EB_3 a_3. (20)$

(12), (13), and (14) $2EB_5 a_6 = \frac{w_4 l_4^3}{12} - \frac{w_5 l_5^3}{12} - E a_5 S_5 - 2EB_4 a_4. (21)$

(15) and (16) $0 = -E a_6 S_6 - 2EB_5 a_5 (22)$

Multiplying (22) by $-\frac{2B_5}{S_6}$ and adding to (21), we get

$$E a_2 \left(S_5 - \frac{4B_5^2}{S_6} \right) = \frac{w_4 l_4^3}{12} - \frac{w_5 l_5^3}{12} \left(1 + \frac{2B_5}{S_6} \right) - 2B_4 E a_4.$$

By substituting this value of Ea_3 in equation (20), an expression may be obtained for Ea_4 , and by repeating this process, we obtain finally,

$$\begin{aligned}
 Ea_1 = & -\frac{w_1 l_1^3}{12} \left[\frac{1 + \frac{2B_1}{S_2 - \frac{4B_2^2}{4B_3^2}}}{S_3 - \frac{4B_3^2}{4B_4^2}} \right. \\
 & \left. \frac{S_4 - \frac{4B_4^2}{4B_5^2}}{S_5 - \frac{4B_5^2}{S_6}} \right] \\
 & + \frac{w_2 l_2^3}{12} \cdot 2B_1 \left[\frac{S_1 - \frac{4B_1^2}{4B_2^2}}{S_2 - \frac{4B_2^2}{4B_3^2}} \right. \\
 & \left. \frac{S_3 - \frac{4B_3^2}{4B_4^2}}{S_4 - \frac{4B_4^2}{4B_5^2}} \right] \left[\frac{S_2 - \frac{4B_2^2}{4B_3^2}}{S_3 - \frac{4B_3^2}{4B_4^2}} \right. \\
 & \left. \frac{S_4 - \frac{4B_4^2}{4B_5^2}}{S_5 - \frac{4B_5^2}{S_6}} \right] \\
 & - \frac{w_3 l_3^3}{12} \cdot 4B_1 B_2 \left[\frac{1 + \frac{2B_3}{S_4 - \frac{4B_4^2}{4B_5^2}}}{S_5 - \frac{4B_5^2}{S_6}} \right] \\
 & \left[\frac{S_1 - \frac{4B_1^2}{4B_2^2}}{S_2 - \frac{4B_2^2}{4B_3^2}} \right. \\
 & \left. \frac{S_3 - \frac{4B_3^2}{4B_4^2}}{S_4 - \frac{4B_4^2}{4B_5^2}} \right] \left[\frac{S_2 - \frac{4B_2^2}{4B_3^2}}{S_3 - \frac{4B_3^2}{4B_4^2}} \right. \\
 & \left. \frac{S_4 - \frac{4B_4^2}{4B_5^2}}{S_5 - \frac{4B_5^2}{S_6}} \right] \\
 & \left[\frac{S_3 - \frac{4B_3^2}{4B_4^2}}{S_4 - \frac{4B_4^2}{4B_5^2}} \right]
 \end{aligned}$$

$$\begin{aligned}
 & + \frac{w_4 l_4^2}{12} \cdot 8B_1 B_2 B_3 \cdot \frac{\left[1 + \frac{2B_1}{S_5 - \frac{4B_3^2}{S_6}} \right]}{\left[\begin{array}{c} S_1 - \frac{4B_2^2}{S_2 - \frac{4B_3^2}{S_3 - \frac{4B_4^2}{S_4 - \frac{4B_5^2}{S_5 - \frac{4B_6^2}{S_6}}}} \\ S_2 - \frac{4B_3^2}{S_3 - \frac{4B_4^2}{S_4 - \frac{4B_5^2}{S_5 - \frac{4B_6^2}{S_6}}} \end{array} \right]} \left[\begin{array}{c} S_2 - \frac{4B_3^2}{S_3 - \frac{4B_4^2}{S_4 - \frac{4B_5^2}{S_5 - \frac{4B_6^2}{S_6}}} \\ S_4 - \frac{4B_5^2}{S_5 - \frac{4B_6^2}{S_6}} \end{array} \right] \\
 & \left[\begin{array}{c} S_3 - \frac{4B_4^2}{S_4 - \frac{4B_5^2}{S_5 - \frac{4B_6^2}{S_6}}} \\ S_4 - \frac{4B_5^2}{S_5 - \frac{4B_6^2}{S_6}} \end{array} \right] \left[\begin{array}{c} S_4 - \frac{4B_5^2}{S_5 - \frac{4B_6^2}{S_6}} \\ S_5 - \frac{4B_6^2}{S_6} \end{array} \right] \\
 & - \frac{w_5 l_5^2}{12} \cdot 16B_1 B_2 B_3 B_4 \cdot \frac{\left[1 + \frac{2B_5}{S_6} \right]}{\left[\begin{array}{c} S_1 - \frac{4B_2^2}{S_2 - \frac{4B_3^2}{S_3 - \frac{4B_4^2}{S_4 - \frac{4B_5^2}{S_5 - \frac{4B_6^2}{S_6}}}} \\ S_2 - \frac{4B_3^2}{S_3 - \frac{4B_4^2}{S_4 - \frac{4B_5^2}{S_5 - \frac{4B_6^2}{S_6}}} \end{array} \right]} \left[\begin{array}{c} S_2 - \frac{4B_3^2}{S_3 - \frac{4B_4^2}{S_4 - \frac{4B_5^2}{S_5 - \frac{4B_6^2}{S_6}}} \\ S_4 - \frac{4B_5^2}{S_5 - \frac{4B_6^2}{S_6}} \end{array} \right] \\
 & \left[\begin{array}{c} S_3 - \frac{4B_4^2}{S_4 - \frac{4B_5^2}{S_5 - \frac{4B_6^2}{S_6}}} \\ S_4 - \frac{4B_5^2}{S_5 - \frac{4B_6^2}{S_6}} \end{array} \right] \left[\begin{array}{c} S_4 - \frac{4B_5^2}{S_5 - \frac{4B_6^2}{S_6}} \\ S_5 - \frac{4B_6^2}{S_6} \end{array} \right] \left[S_5 - \frac{4B_6^2}{S_6} \right]
 \end{aligned}$$

APPENDIX 10.

Continuous beam of many spans uniformly live loaded on alternate bays and monolithic with the columns (Fig. 148).

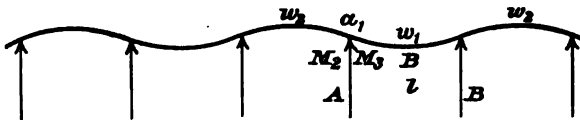

FIG. 148.—Continuous beam uniformly loaded on alternate bays.

- To find (i) the slope of the beam at the columns,
 (ii) the moment in the beam at the centre of the span,
 (iii) the reaction on the columns.

Consider that portion of the beam spanning from A to B. From Appendix 1, the moment in the beam at the left support A is

$$M_1 = -\frac{w_1 l^2}{12} - 2EBa_1 \quad \text{since } a_1 = -a_2$$

(i) The moment at the centre of the beam

$$M_o = \frac{w_1 l^2}{8} + M_1 = \frac{w_1 l^2}{24} - 2EBa_1$$

and

$$M_2 = -\frac{w_2 l^2}{12} + 2EBa_1.$$

Equating the moments at the top of column A,

$$M_1 = M_2 - E a_1 K C$$

$$-\frac{w_1 l^2}{12} + 2EBa_1 = -\frac{w_1 l^2}{12} - 2EBa_1 - E a_1 K C.$$

$$E a_1 (K C + 4B) = -\frac{w_1 l^2}{12} + \frac{w_2 l^2}{12}$$

$$E a_1 = -\frac{l^2}{12} \cdot \frac{(w_1 - w_2)}{(K C + 4B)}$$

which gives the slope of the beam at the column.

(ii) The moment in the beam at the centre of the span

$$M_o = \frac{w_1 l^2}{24} + \frac{2B l^2}{12} \cdot \frac{(w_1 - w_2)}{(K C + 4B)}$$

when $K C = 0$,

$$M_o = \frac{w_1 l^2}{12} - \frac{w_2 l^2}{24} = \frac{w_1 l^2}{12} \cdot \left(1 - \frac{w_2}{2w_1}\right).$$

(iii) The reaction on the columns

$$\text{Total R} = \frac{(w_1 + w_2)l}{2}.$$

APPENDIX 11.

Continuous beam of many spans, uniformly loaded as shown in Fig. 149, monolithic with the columns.

To find (i) the maximum moment at the support A of the beam,
(ii) the reaction on the support A.

With this type of loading, which gives the maximum moment which can occur at the support of a beam, and also the maximum

value of the reaction on a column, $a_3 = 0$ and $a_1 = a_2$, which greatly simplifies the result.

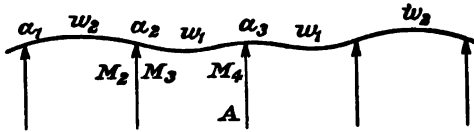

FIG. 149.—Continuous beam loaded to give maximum moment at a beam support.

From the data given in Appendix 1, we can write down the following equations:—

$$M_2 = -\frac{w_2 l^2}{12} + 2EBa_2 \dots \dots \dots (1)$$

$$M_3 = -\frac{w_1 l^2}{12} - 4EBa_2 \dots \dots \dots (2)$$

$$M_4 = -\frac{w_1 l^2}{12} + 2EBa_2 \dots \dots \dots (3)$$

$$M_2 = M_3 - KCEa_2 \dots \dots \dots (4)$$

Substituting (1) and (2) in (4),

$$\begin{aligned} -\frac{w_2 l^2}{12} + 2EBa_2 &= -\frac{w_1 l^2}{12} - 4EBa_2 - KCEa_2 \\ + 2EBa_2 &= -\frac{l^2}{12} \cdot \frac{2B(w_1 - w_2)}{KC + 6B}. \end{aligned}$$

And substituting this value in equation (3), we get M_4 , which is the moment in the beam at the support A.

$$\begin{aligned} (i) \quad M_4 &= -\frac{w_1 l^2}{12} - \frac{l^2}{12} \cdot \frac{2B(w_1 - w_2)}{KC + 6B} \\ &= -\frac{w_1 l^2}{12} \cdot \frac{(KC + 8B)}{(KC + 6B)} + \frac{w_2 l^2}{12} \cdot \frac{2B}{(KC + 6B)}. \end{aligned}$$

When KC is zero,

$$M_4 = -\frac{w_1 l^2}{9} + \frac{w_2 l^2}{36}.$$

(ii) To find the reaction R at the support A, $\frac{R}{2}$ being the reaction at A due to the loads to the left of A.

$$\begin{aligned} \frac{R}{2} &= \frac{w_1 l}{2} - \frac{(M_4 - M_3)}{l} \\ &= \frac{w_1 l}{2} - \frac{6EBa_2}{l} \end{aligned}$$

$$= \frac{w_1 l}{2} + \frac{l}{12} \cdot \frac{6B(w_1 - w_2)}{KC + 6B}$$

$$\therefore R = w_1 l + (w_1 - w_2) l \cdot \frac{B}{(KC + 6B)}$$

When KC is zero,

$$R = \frac{7}{6} w_1 l - \frac{w_2 l}{6}$$

APPENDIX 12.

Continuous beam of many spans, live loaded on alternate bays, with a triangular distribution of both live and dead loads, the beam being monolithic with the columns (Fig. 150).

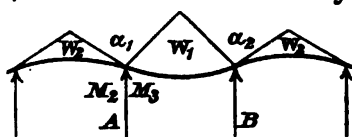

FIG. 150.—Continuous beam with triangular distribution of loads.

- To find (i) the value of the moment in the beam at the centre of the span,
(ii) the slope of the beam at the column,
(iii) the reaction R on the column.

Consider that portion of the beam spanning from A to B .

From Appendix I, 2, remembering that for this case $\alpha_1 = -\alpha_2$ the moment in the beam at the left support is

$$M_3 = -\frac{5}{48} W_1 l - 2EBa_1$$

and

$$M_2 = -\frac{5}{48} W_2 l + 2EBa_1$$

Equating the moments at the top of column A ,

$$M_2 = M_3 - KCEa_1$$

$$-\frac{5}{48} W_2 l + 2EBa_1 = -\frac{5}{48} W_1 l - 2EBa_1 - KCEa_1$$

We may obtain (i) the expression for the slope of the beam at the column,

$$Ea_1 = -\frac{5}{48} l \cdot \frac{(W_1 - W_2)}{(KC + 4B)}$$

(ii) The moment in the beam at the centre of the span,

$$M_c = \frac{W_1 l}{6} + M_3$$

$$= \frac{W_1 l}{16} - 2EBa_1$$

$$= \frac{W_1 l}{16} + \frac{10Bl}{48} \cdot \frac{(W_1 - W_2)}{(KC + 4B)}$$

When $KC = 0$,

$$M_c = \frac{W_1 l}{16} + \frac{5}{98} W_1 l - \frac{5}{98} W_2 l$$

$$= \frac{11}{98} W_1 l - \frac{5}{98} W_2 l.$$

(iii) The total reaction on the columns

$$R = \frac{W_1 + W_2}{2}.$$

APPENDIX 13.

Continuous beam with a triangular distribution of load, as shown in Fig. 151, monolithic with the columns.

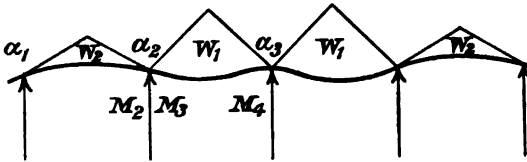

FIG. 151.—Continuous beam with triangular distribution of load.

To find (i) the maximum moment in the beam at the support A,
 (ii) the total reaction on the support A.

From symmetry it is obvious that $a_3 = 0$ and $a_1 = -a_2$.

From the data given in Appendix 2, we may write down the four following equations :—

$$M_2 = -\frac{5}{48} W_2 l + 2EBa_2 \dots \dots \dots (1)$$

$$M_3 = -\frac{5}{48} W_1 l - 4EBa_2 \dots \dots \dots (2)$$

$$M_4 = -\frac{5W_1 l}{48} + 2EBa_2 \dots \dots \dots (3)$$

$$M_2 = M_3 - KCEa_2 \dots \dots \dots (4)$$

Substituting (1) and (2) in (4),

$$-\frac{5W_2 l}{48} + 2EBa_2 = -\frac{5}{48} W_1 l - 4EBa_2 - KCEa_2$$

$$2EBa = -\frac{5}{48} \cdot \frac{2B \cdot l(W_1 - W_2)}{KC + 6B}$$

and substituting this value in equation (3), we get M_4 , which is

(i) The moment in the beam at the support A,

$$M_4 = -\frac{5}{48} W_1 l - \frac{5}{48} \cdot \frac{2B \cdot l(W_1 - W_2)}{(KC + 6B)}$$

$$= -\frac{5}{48} W_1 l \cdot \left(\frac{KC + 8B}{KC + 6B} \right) + \frac{5W_2 l}{48} \cdot \frac{2B}{(KC + 6B)}$$

When KC is zero,

$$M_4 = -\frac{5}{32}W_1l + \frac{5}{144}W_2l.$$

(ii) To find the reaction R at the support A , $\frac{R}{2}$ being the reaction at A due to the loads to the left of A .

$$\begin{aligned} \frac{R}{2} &= \frac{W_1}{2} - \frac{(M_4 - M_3)}{l} \\ &= \frac{W_1}{2} - \frac{6EBa_2}{l} = \frac{W_1}{2} + \frac{5}{8} \cdot \frac{B(W_1 - W_2)}{(KC + 6B)}. \\ R &= W_1 + \frac{5}{4} \cdot \frac{B(W_1 - W_2)}{(KC + 6B)}. \end{aligned}$$

When KC is zero,

$$R = \frac{29}{24}W_1 - \frac{5}{24}W_2.$$

APPENDIX 14.

Continuous beam of many spans, live loaded with a concentrated load at the centre of alternate bays, and monolithic with the columns (Fig. 152).

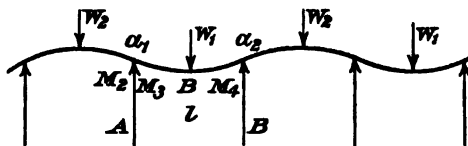

FIG. 152.—Continuous beam with concentrated loads.

- To find (i) the value of the moment in the beam at the centre of the span,
 (ii) the slope of the beam at the columns,
 (iii) the reaction R on the columns.

Consider that portion of the beam spanning from A to B .

(i) From Appendix 3, the moment in the beam at the left support

$$M_3 = -\frac{W_1l}{8} - 2EBa_1$$

and

$$M_2 = -\frac{W_2l}{8} + 2EBa_1.$$

Equating the moments at the top of the column A,

$$\begin{aligned} M_2 &= M_3 - KCE\alpha_1 \\ -\frac{W_2l}{8} + 2EB\alpha_1 &= -\frac{W_1L}{8} - 2EB\alpha_1 - KCE\alpha_1 \\ E\alpha_1 &= -\frac{l}{8} \cdot \frac{(W_1 - W_2)}{(KC + 4B)} \end{aligned}$$

which gives the slope of the beam at the column.

(ii) The moment in the beam at the centre of the span

$$\begin{aligned} M_c &= \frac{W_1l}{4} + M_3 \\ &= \frac{W_1l}{8} - 2EB\alpha_1 \\ &= \frac{W_1l}{8} + \frac{2Bl}{8} \cdot \frac{(W_1 - W_2)}{(KC + 4B)}. \end{aligned}$$

When $KC = 0$,

$$\begin{aligned} M_c &= \frac{W_1l}{8} + \frac{W_1l}{16} - \frac{W_2l}{16} \\ &= \frac{3}{16}W_1l - \frac{W_2l}{16}. \end{aligned}$$

(iii) The total reaction on the columns

$$R = \frac{W_1 + W_2}{2}.$$

APPENDIX 15.

Continuous beam loaded as shown in Fig. 153, supported on columns which are monolithic with the beam.

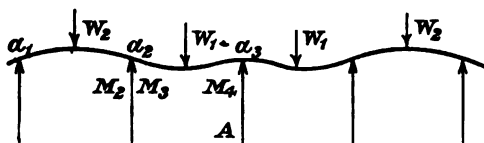

FIG. 153.—Continuous beam with concentrated loads.

To find (i) the maximum moment in the beam at the support A,
(ii) the total reaction on the support A.

This type of loading gives the maximum moment at the support

of a continuous beam, and also the maximum value of the reaction on any column.

From symmetry it is obvious that $a_2 = 0$ and $a_1 = -a_2$, which greatly simplifies the problem.

From the data given in Appendix 3, we may write down the four following equations:—

$$M_2 = -\frac{W_2 l}{8} + 2EBa_2 \dots \dots \dots (1)$$

$$M_3 = -\frac{W_1 l}{8} - 4EBa_2 \dots \dots \dots (2)$$

$$M_4 = -\frac{W_1 l}{8} + 2EBa_2 \dots \dots \dots (3)$$

$$M_2 = M_3 - KCEa_2 \dots \dots \dots (4)$$

Substituting (1) and (2) in (4),

$$\begin{aligned} -\frac{W_2 l}{8} + 2EBa_2 &= -\frac{W_1 l}{8} - 4EBa_2 - KCEa_2 \\ +2EBa_2 &= -\frac{l}{8} \cdot \frac{2B(W_1 - W_2)}{KC + 6B} \end{aligned}$$

and substituting this value in equation (3), we get M_4 , which is

(i) The moment in the beam at the support A,

$$\begin{aligned} M_4 &= -\frac{W_1 l}{8} - \frac{l}{8} \cdot \frac{2B(W_1 - W_2)}{(KC + 6B)} \\ &= -\frac{W_1 l}{8} \left(\frac{KC + 8B}{(KC + 6B)} \right) + \frac{W_2 l}{8} \cdot \frac{2B}{(KC + 6B)} \end{aligned}$$

When KC is zero,

$$M_4 = -\frac{W_1 l}{6} + \frac{W_2 l}{24}$$

(ii) To find the reaction R at the support A, $\frac{R}{2}$ being the reaction at A due to the loads to the left of A,

$$\begin{aligned} \frac{R}{2} &= \frac{W_1}{2} - \frac{(M_4 - M_3)}{l} \\ &= \frac{W_1}{2} - \frac{-6EBa_2}{l} = \frac{W_1}{2} + \frac{6B(W_1 - W_2)}{8(KC + 6B)} \\ R &= W_1 + \frac{1.5B(W_1 - W_2)}{KC + 6B} \end{aligned}$$

When KC is zero,

$$R = \frac{5}{2}W_1 - \frac{W_2}{4}.$$

APPENDIX 16.

Continuous beam of many spans, live loaded on alternate bays with two point loads at the third points for both live and dead loads as shown in Fig. 154, the beam being monolithic with the columns.

To find (i) the value of the moment in the beam at the centre of the span,

(ii) the slope of the beam at the column,

(iii) the reaction R on the column.

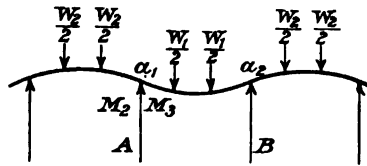

FIG. 154.

Consider that portion of the beam spanning from A to B in the figure.

From Appendix I. 4, remembering that from symmetry $a_1 = -a_2$, the moment in the beam at the left support is

$$M_3 = -\frac{W_1 l}{9} - 2EBa_1$$

and

$$M_2 = -\frac{W_2 l}{9} + 2EBa_1.$$

Equating the moments at the top of column A,

$$\begin{aligned} M_2 &= M_3 - KCEa_1 \\ -\frac{W_2 l}{9} + 2EBa_1 &= -\frac{W_1 l}{9} - 2EBa_1 - KCEa_1. \end{aligned}$$

(i) We may obtain the expression for the slope of the beam at the column,

$$Ea_1 = -\frac{l}{9} \cdot \frac{(W_1 - W_2)}{(KC + 4B)}.$$

(ii) The moment in the beam at the centre of the span,

$$M_c = \frac{W_1 l}{6} + M_3$$

$$\begin{aligned}
 &= \frac{W_1 l}{18} - 2EBa_1 \\
 &= \frac{W_1 l}{18} + \frac{2}{9} \cdot \frac{B(W_1 - W_2)}{(KC + 4B)}
 \end{aligned}$$

When $KC = 0$,

$$\begin{aligned}
 M_c &= \frac{W_1 l}{18} + \frac{W_1 l}{18} - \frac{W_2 l}{18} \\
 &= \frac{W_1 l}{9} - \frac{W_2 l}{18}
 \end{aligned}$$

(iii) The total reaction on the column,

$$R = \frac{W_1 + W_2}{2}$$

APPENDIX 17.

Continuous beam of many spans with concentrated loads at the third points (Fig. 155), supported on columns which are monolithic

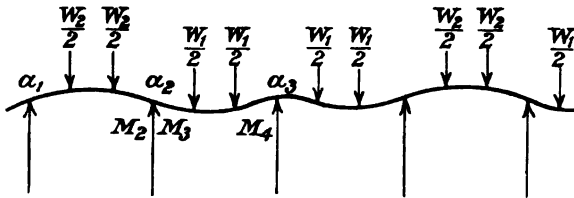

FIG. 155.

with the beam. The moment of inertia of the beam being constant throughout its whole length, all spans equal, and all columns of the same size.

- To find (i) the maximum moment in the beam at the support A,
- (ii) the total reaction on the support A.

From symmetry it is obvious that with this type of loading $a_3 = 0$ and $a_1 = -a_2$.

From the data given in Appendix 4 we may write down the four following equations :—

$$M_2 = -\frac{W_2 l}{9} + 2EBa_2 \dots \dots \dots (1)$$

$$M_3 = -\frac{W_1 l}{9} - 4EBa_2 \dots \dots \dots (2)$$

$$M_1 = -\frac{W_1 l}{9} + 2EBa_2 \dots \dots \dots (3)$$

$$M_2 = M_3 + KCEa_2 \dots \dots \dots (4)$$

Substituting (1) and (2) in (4),

$$-\frac{W_2 l}{9} + 2EBa_2 = -\frac{W_1 l}{9} - 4EBa_2 - KCEa_2$$

$$2EBa_2 = -\frac{2B}{9} \cdot \frac{l(W_1 - W_2)}{KC + 6B}$$

and substituting this value in equation (3) we get M_1 , which is

(i) The moment in the beam at the support A.

$$M_1 = -\frac{W_1 l}{9} - \frac{2Bl}{9} \cdot \frac{(W_1 - W_2)}{(KC + 6B)}$$

$$= -\frac{W_1 l}{9} \cdot \frac{(KC + 8B)}{(KC + 6B)} + \frac{W_2 l}{9} \cdot \frac{2B}{(KC + 6B)}$$

When $KC = 0$,

$$M_1 = -\frac{4W_1 l}{27} + \frac{W_2 l}{27}$$

(ii) To find the reaction R at the support A, $\frac{R}{2}$ being the reaction at A due to the loads to the left at A.

$$\frac{R}{2} = \frac{W_1}{2} - \frac{(M_1 - M_2)}{l}$$

$$= \frac{W_1}{2} - \frac{6EBa_2}{l} = \frac{W_1}{2} + \frac{2}{3} \cdot \frac{B(W_1 - W_2)}{(KC + 6B)}$$

$$R = W_1 + \frac{4}{3} \cdot \frac{B(W_1 - W_2)}{(KC + 6B)}$$

When $KC = 0$,

$$R = \frac{11}{9}W_1 - \frac{2}{9}W_2$$

APPENDIX 18.

A beam under a load uniformly varying from zero at one end to a maximum at the other, given the slopes at the ends.

To find (i) the value of the moments at the ends in terms of the load and the slopes at the ends, when w , the load per unit run at the end of the beam, is equal to δl (Fig. 156).

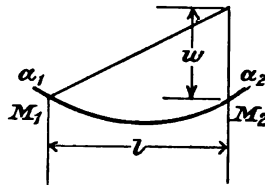

FIG. 156.—Beam under load varying from zero to maximum at one end.

Proceeding as before, we may write down the equation to the moments in the beam.

$$EI \frac{d^2y}{dx^2} = M_1 + R_1x - \frac{\delta x^3}{6}$$

$$EI \frac{dy}{dx} = M_1x + \frac{R_1x^2}{2} - \frac{\delta x^4}{24} + K,$$

and when $x = 0$,

$$\frac{dy}{dx} = d_1$$

and therefore

$$K_1 = EIa_1.$$

$$EI \frac{dy}{dx} = M_1x + \frac{R_1x^2}{2} - \frac{\delta x^4}{24} + EIa_1 \quad \dots \quad (1)$$

When $x = l$,

$$\frac{dy}{dx} = a_2$$

$$EIa_2 = M_1l + \frac{R_1l^2}{2} - \frac{\delta l^4}{24} + EIa_1 \quad \dots \quad (2)$$

Integrating equation (1),

$$EIy = \frac{M_1x^2}{2} + \frac{R_1x^3}{6} - \frac{\delta l^5}{120} + EIa_1x + K_2$$

and when $x = 0$, $y = 0$, and therefore $K_2 = 0$.

Substituting the value $x = l$, in which case also $y = 0$, we get—

$$0 = \frac{M_1l^2}{2} + \frac{R_1l^3}{6} - \frac{\delta l^5}{120} + EIa_1l \quad \dots \quad (3)$$

Dividing this by l and multiplying by three, and subtracting equation (2) from the result,

$$-EIa_2 = \frac{M_1l}{2} + \frac{\delta l^4}{60} + 2EIa_1$$

whence

$$M_1 = -\frac{\delta l^3}{30} - \frac{2EIa_2}{l} - \frac{4EIa_1}{l} \quad \dots \quad (4)$$

From equation (3),

$$R_1l = -3M_1 + \frac{\delta l^3}{20} - CEBa_1.$$

Putting $x = l$ in our first equation and substituting this value of R_1l , we get

$$M_2 = \frac{\delta l^3}{15} + 4EBa_2 + CEBa_1 + \frac{\delta l^3}{20} - 6EBa_1 - \frac{\delta l^3}{6}$$

$$= -\frac{\delta l^3}{20} + 4EBa_2 + 2EBa_1 \quad \dots \quad (5)$$

When both ends of the beam are free.

The maximum positive moment will occur near the centre of the beam at such a point that the shear is zero. R_1 will for this be a third of the total load, that is

$$R_1 = \frac{\delta l^2}{6}.$$

To find the distance x of the point of zero shear from the left support,

$$\frac{\delta x^2}{2} = \frac{\delta l^2}{6},$$

hence $x = 0.577l$,

$$\text{and } M_c = 0.577 \times \frac{\delta l^2}{6} - 0.192 \frac{\delta l^2}{6} = 0.0644 \delta l^2 = \frac{\delta l^2}{15.5} = \frac{wl^2}{15.5}.$$

When both ends of the beam are fixed,

$$M_1 = -\frac{\delta l^2}{30} = -\frac{wl^2}{30}, \text{ and } M_2 = -\frac{\delta l^2}{20} = -\frac{wl^2}{20}.$$

To find the value of the maximum positive moment,

$$\begin{aligned} R_1 &= -\frac{3M_1}{l} + \frac{\delta l^2}{20}, \text{ and } M_1 = -\frac{\delta l^2}{30} \\ &= \frac{\delta l^2}{10} + \frac{\delta l^2}{20} = \frac{3}{20} \delta l^2 = \frac{3}{20} wl. \end{aligned}$$

The distance x of the maximum positive moment

$$\frac{\delta x^2}{2} = \frac{3}{20} \delta l^2 \quad \therefore x = 0.548l$$

$$M_c = -\frac{\delta l^2}{30} + \frac{3}{20} \delta l^2 x - \frac{\delta x^3}{6} = \frac{\delta l^2}{46.7} = \frac{wl^2}{46.7}.$$

When $\alpha_1 = 0$ and $M_2 = 0$, that is, when the beam is fixed at the left support and free at the other.

Substituting these values in equation (5),

$$0 = -\frac{\delta l^2}{20} + 4EB\alpha_2,$$

$$\text{and hence } M_1 = -\frac{\delta l^2}{30} - \frac{\delta l^2}{40} = -\frac{7}{120} \delta l^2 = -\frac{\delta l^2}{17.1} = -\frac{wl^2}{17.1}$$

$$R_1 = -\frac{3M_1}{l} + \frac{\delta l^2}{20} = +\frac{21}{120} \delta l^2 + \frac{\delta l^2}{20} = \frac{9}{40} \delta l^2 = \frac{9}{40} wl.$$

The distance x of the maximum positive moment from the left support

$$\frac{\delta x^2}{2} = \frac{9}{40} \delta l^2$$

therefore

$$x = 0.671l,$$

and therefore

$$\begin{aligned} M_c &= -\frac{7}{120} \delta l^2 + \frac{9}{40} \delta l^2 \times 0.671 - \frac{\delta l^2}{6} (0.671)^2 \\ &= 0.04248 \delta l^2 = \frac{\delta l^2}{23.6} = \frac{wl^2}{23.6}. \end{aligned}$$

When $a_2 = 0$ and $M_1 = 0$, that is, when the beam is fixed at the right-hand support and free at the other.

Substituting these values in equation (4),

$$0 = -\frac{\delta l^3}{30} - 4EBa_1$$

and hence

$$M_2 = -\frac{\delta l^3}{20} - \frac{\delta l^3}{60} = -\frac{\delta l^3}{15} = -\frac{wl^3}{15}$$

$$\begin{aligned} R_1 &= -\frac{3M_1}{l} + \frac{\delta l^2}{20} - \frac{6EBa_1}{l} \\ &= \frac{\delta l^2}{20} + \frac{\delta l^2}{20} = \frac{\delta l^2}{10} = \frac{wl}{10}. \end{aligned}$$

The distance x of the maximum positive moment from the left support

$$\frac{\delta x^2}{2} = \frac{\delta l^2}{10}$$

therefore

$$x = 0.447l$$

and therefore

$$\begin{aligned} M_c &= 0 + 0.0447 \delta l^2 - \frac{\delta l^2}{6} (0.447)^2 \\ &= 0.02988 \delta l^2 \\ &= \frac{\delta l^2}{33.6} = \frac{wl^2}{33.6}. \end{aligned}$$

APPENDIX 19.

Effect of settlement of supports on the centre moments of continuous beams.

The case taken is for a beam of many spans. A certain bay has a load w , and its two supports settle a distance δ . The adjacent

spans have a load w_1 , and their end supports do not settle. The beams are supposed fixed in direction at these supports (Fig. 157).

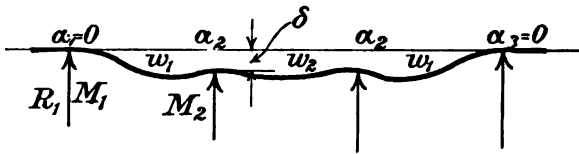

FIG. 157.—Effect of settlement on beam of many spans.

We may write down the equation to the moments at any point in the beam, omitting some of the intermediate steps, as follows:—

$$EI \frac{d^2y}{dx^2} = R_1x - \frac{w_1x^2}{2} + M_1.$$

When $x = l$,

$$M_2 = R_1l - \frac{w_1l^2}{2} + M_1 \quad \dots \quad (1)$$

$$EI \frac{dy}{dx} = \frac{R_1x^2}{2} - \frac{w_1x^3}{6} + M_1x$$

When $x = l$,

$$EI\alpha_2 = \frac{R_1l^2}{2} - \frac{w_1l^3}{6} + M_1l \quad \dots \quad (2)$$

$$EIy = \frac{R_1x^3}{6} - \frac{w_1x^4}{24} + \frac{M_1x^2}{2}$$

When $x = l$, $y = \delta$, and therefore

$$EI\delta = \frac{R_1l^3}{6} - \frac{w_1l^4}{24} + \frac{M_1l^2}{2} \quad \dots \quad (3)$$

And from Appendix 1, knowing that the centre bay is symmetrical, we may write

$$M_2 = -\frac{w_2l^2}{12} - \frac{2EI\alpha_2}{l} \quad \dots \quad (4)$$

Substituting in equation (2) the value of M_1 in (1),

$$-\frac{2EI\alpha_2}{l} = -2M_2 - \frac{2}{3}w_1l^2 + R_1l \quad \dots \quad (5)$$

Multiplying (3) by $\frac{2}{l^2}$ and subtracting from (1),

$$M_2 - \frac{2EI\delta}{l^2} = R_1l - \frac{w_1l^2}{2} - \frac{R_1l}{3} + \frac{w_1l^2}{12}$$

or

$$R_1l = \frac{2}{3}M_2 - \frac{3EI\delta}{l^2} + \frac{5}{8}w_1l^2$$

Substituting this value in equation (5),

$$-\frac{2EI\alpha_2}{l} = -\frac{M_2}{2} - \frac{3EI\delta}{l^2} - \frac{w_1 l^3}{24}$$

And substituting this in equation (4),

$$M_2 = -\frac{w_2 l^3}{18} - \frac{2EI\delta}{l^2} - \frac{w_1 l^3}{36}$$

and consequently the moment at the centre of the centre span

$$M_c = \frac{5}{72}w_2 l^3 - \frac{2EI\delta}{l^2} - \frac{w_1 l^3}{36}$$

And δ will be negative when there is settlement below the original position.

APPENDIX 20.

Effect of settlement of supports on centre moments of continuous beams of two spans (Fig. 158).

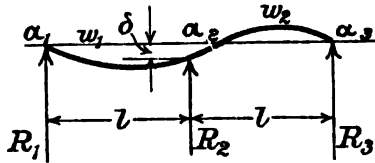

FIG. 158.—Effect of settlement on continuous beam of two spans.

We may write down the equation to the moments at any point in the beam as—

$$M = EI \frac{d^2y}{dx^2} = R_1x - \frac{w_1x^2}{2}$$

Integrating,

$$EI \frac{dy}{dx} = \frac{R_1x^2}{2} - \frac{w_1x^3}{6} + EI\alpha_2 - \frac{R_1l^2}{2} + \frac{w_1l^3}{6}$$

Integrating,

$$EIy = \frac{R_1x^3}{6} - \frac{w_1x^4}{24} + EI\alpha_2x - \frac{R_1l^2x}{2} + \frac{w_1l^3x}{6}$$

When $x = l, y = \delta,$

$$EI\delta = \frac{R_1l^3}{6} - \frac{w_1l^4}{24} + EI\alpha_2l - \frac{R_1l^3}{2} + \frac{w_1l^4}{6}$$

$$EI\delta = -\frac{R_1l^3}{3} + \frac{w_1l^4}{8} + EI\alpha_2l \dots \dots \dots (1)$$

Working from the other end

$$EI\delta = -\frac{R_2 l^3}{3} + \frac{w_2 l^4}{8} - EI\alpha_2 l \quad \dots \quad (2)$$

$$\text{And } R_1 l - \frac{w_1 l^2}{2} = R_2 l - \frac{w_2 l^2}{2} \quad \dots \quad (3)$$

Multiplying (1) and (2) by $\frac{3}{l^3}$ we get

$$\frac{3EI\delta}{l^3} = -R_1 l + \frac{3}{8}w_1 l^2 + \frac{3EI\alpha_2}{l} \quad \dots \quad (4)$$

$$-\frac{3EI\delta}{l^3} = -R_2 l + \frac{3}{8}w_2 l^2 - \frac{3EI\alpha_2}{l} \quad \dots \quad (5)$$

From equation (3),

$$-R_2 l = -R_1 l + \frac{w_1 l^2}{2} - \frac{w_2 l^2}{2}$$

And substituting this value in (5),

$$\frac{3EI\delta}{l^3} = -R_1 l + \frac{w_1 l^2}{2} - \frac{w_2 l^2}{8} - \frac{3EI\alpha_2}{l}$$

Adding this to (4),

$$\frac{6EI\delta}{l^3} = -2R_1 l + \frac{7}{8}w_1 l^2 - \frac{w_2 l^2}{8}$$

$$\text{or } R_1 = \frac{7}{16}w_1 l - \frac{w_2 l}{16} - \frac{3EI\delta}{l^3} \quad \dots \quad (6)$$

As is well known, the maximum moment near the centre of the beam occurs where the shear is zero.

Now, $R_1 = w_1 x$, where x is the distance to the point of no shear, hence the positive moment at this point is

$$M_o = R_1 x - \frac{w_1 x^2}{2} = R_1 x - \frac{R_1 x}{2} = \frac{R_1 x}{2} = \frac{R_1^2}{2w_1}$$

In substituting numerical values in the above, it should be remembered that a deflection downwards is to be considered negative.

APPENDIX II

R.I.B.A. REPORT ON REINFORCED CONCRETE (1911)

THE authors have attempted in the preceding chapters to state their views on some of the more important questions appertaining to reinforced concrete design, and in some cases to give formulæ and principles which they consider more nearly approximate to the truth than those enunciated in commonly accepted reports.

Realizing, however, that for small jobs not designed by a specialist, standard reports must be very helpful, even though they may in some cases be considerably on the safe side of truth (when $\frac{wl^2}{12}$ be taken as the bending moment in a nearly continuous beam, for example), and in others on the wrong side (when moments are neglected in columns, especially in outside columns), the authors have included, by kind permission of the R.I.B.A., their last report on the subject, which is probably one of the best of those issued in the English tongue.

The regulations on columns, though based on the French report of 1907, are put into more systematic form, which increases its general usefulness.

SECOND REPORT OF THE JOINT COMMITTEE ON REINFORCED CONCRETE.*

KEY TO THE NOTATION.

The notation is built up on the principle of an index.

The significant words in any term are abbreviated down to their initial letter, and there are no exceptions.

Capital letters indicate moments, areas, volumes, total forces, total loads, ratios, and constants, etc.

Small letters indicate intensity of forces, intensity of loads, and

* Reprinted by kind permission of the Council of the Royal Institute of British Architects.

intensity of stresses, lineal dimensions (lengths, distances, etc.), ratios, and constants, etc.

Dashed letters indicate ratios, such as a , c , n , etc., where the a , c , and n indicate the numerators in the respective ratios. The dash itself is mnemonic and is an abbreviation of that longer dash which indicates division or ratio.

Subscript letters are only used where one letter is insufficient; and the subscript letters themselves are the initial or distinctive letters of the qualifying words.

Greek letters indicate ratios and constants. They are sparingly used and are subject to the "initial letter" principle.

The symbols below are arranged in alphabetical order for facility of reference.

STANDARD NOTATION.

(In pillars) A = the effective *area* of the pillar (see definition page 317).

A_x = *Area equivalent* to some given area or *area of an equivalent section* or equivalent area.

A_s = cross-sectional *area* of a vertical or diagonal *shear* member, or group of shear members, in the length p , where p = pitch of stirrups.

A_t = *Area* of *tensile* reinforcement (in square inches).

(In pillars) A_v = *Area* of *vertical* or longitudinal reinforcement in square inches.

a = *arm* of the resisting moment or lever *arm* (in inches).

a_r = *arm ratio* = a/d $\therefore a, d = a$.

B = *Bending* moment of the external loads and reactions (in pound-inches).

$B_1 B_2$ = *Bending* moments at consecutive cross-sections.

Generally b = *breadth*.

(In tee beams) b = *breadth* of flange of beam (in inches).

b_r = *breadth* of rib of T beam (in inches).

$C_1 C_2 C_3$ = a series of *constants*.

(In beams) c = *compressive* stress on the compressed edge of the concrete (in pounds per square inch).

(In pillars) c = working *compressive* stress on the concrete of the hooped core.

c_p = the working *compressive* stress on a *prism* of concrete (not hooped) or the working *compressive* stress of *plain* concrete.

c_u = *compressive* stress on concrete at the *under-side* of the slab (in tee beams).

$c_s = c/t$ = the ratio of c to t .

In circular sections

generally d = diameter.

In rectangular sections

generally d = depth.

(In pillars) d = the *diameter* of the hooped core in inches.

(In beams) d = effective *depth* of the beam (in inches).

(In beams) d_c = *depth* or *distance* of the *centre* of compression from the compressed edge.

d_n = *deflection*.

d_s = total *depth* of the *slab* (in inches).

(In pillars) d_b = *distance* between the centres of *vertical* bars measured perpendicular to the neutral axis.

E_c = *Elastic* modulus of *concrete* (in pounds per square inch).

E_s = *Elastic* modulus of *steel* (in pounds per square inch).

e = *eccentricity* of the load measured from the centre of the pillar (in inches).

(In beams) f = extreme *fibre* stress, *i.e.* stress at the extreme "fibre" of any member under transverse load.

(In pillars) f = a *form* factor or constant which will vary according to whether the hooping is curvilinear or rectilinear, etc.

I = *Inertia* moment of a member.

I_c = *Inertia* moment of *concrete* only.

I_s = *Inertia* moment of *steel* only.

I_{xx} = *Inertia* moment on axis xx when necessary.

I_{yy} = *Inertia* moment on axis yy when necessary.

l = *length* of a pillar or effective length of span of beam or slab.

m = *modular* ratio = E_s/E_c .

N = a numerical coefficient.

n = neutral axis depth, *i.e.* depth of neutral axis from the extreme compressed edge (in inches).

$n_1 = n/d$ = the neutral axis ratio $\therefore n, d = n_1 d$.

N_1, N_2, N_3 = a series of numerical coefficients.

P = total safe pressure.

(In pillars) p = the pitch of the laterals in inches (*i.e.* the axial spacing of the laterals).

(In shear formulæ) p = pitch or distance apart (centre to centre) of the shear members or groups of shear members (measured horizontally).

π = peripheral ratio or the ratio of the circumference of a circle to its diameter.

R_c = Compressive Resistance moment = Resistance moment of the beam in terms of the compressive stress (in pound-inch units).

R_t = Tensile Resistance moment or Resistance moment in terms of the tensile stress (in pound-inches).

(In beams) $r = A_s/bd$ = ratio of area of tensile reinforcement to the area bd .

(In pillars) $r = V_s/V$ = the ratio of volumes, *i.e.* the ratio of the volume of helical or horizontal reinforcement to the volume of hooped core.

(In beams) S = the total shear in pounds at a vertical section.

S_m = the section modulus.

(In pillars) s = Spacing factor or constant which will vary with the pitch of the laterals.

(In beams) s = intensity of the shearing stress on concrete in pounds per square inch.

s_s = shearing stress on the steel (in units of force per unit of area).

(In beams) $s_1 = d_1/d$ = the slab depth ratios.

T = Total tension in the steel (in pounds).

T_1, T_2 = Total tensile forces at consecutive cross-sections.

t = tensile stress on the steel (in pounds per square inch).

U = Total *ultimate* breaking load on any member.
(Compare W = *Working* load.)

u = intensity of *ultimate* crushing resistance of plain concrete per unit of area or ultimate compressive stress on prisms of concrete not hooped.

(In pillars) V = *Volume* of hooped core in cubic inches.

(In pillars) V_r = *Volume* of *hooping* reinforcement in cubic inches.

W = total *working* load or *weight* on any member.

(In pillars) W_F = the *working factor* = c_p/u = the reciprocal of the safety factor.

w = *weight* or load per unit of length or span.

PREFATORY NOTE.

1. Reinforced concrete is used so much in building and engineering construction that a general agreement on the essential requirements of good work is desirable. The proposals which follow are intended to embody these essentials, and to apply generally to all systems of reinforcement.

Good workmanship and materials are essential in reinforced concrete. With these and good design structures of this kind appear to be trustworthy. It is essential that the workmen employed should be skilled in this class of construction. Very careful superintendence is required during the execution of the work in regard to—

- (a) The quality, testing, and mixing of the materials.
- (b) The sizes and positions of the reinforcements.
- (c) The construction and removal of centering.
- (d) The laying of the material in place and the thorough punning of the concrete to ensure solidity and freedom from voids.

If the metal skeleton be properly coated with cement, and the concrete be solid and free from voids, there is no reason to fear decay of the reinforcement in concrete of suitable aggregate and made with clean fresh water.

2. The By-laws regulating building in this country require external walls to be in brick, or stone, or concrete of certain specified thicknesses. In some places it is in the power of the local authorities to permit a reduced thickness of concrete when it is strengthened by metal; in other districts no such power has

been retained. We are of opinion that all By-laws should be so altered as to expressly include reinforced concrete amongst the recognized forms of construction.

A section should be added to the By-laws declaring that when it is desired to erect buildings in reinforced concrete complete drawings showing all details of construction and the sizes and positions of reinforcing bars, a specification of the materials to be used and proportions of the concrete, and the necessary calculations of strength based on the rules contained in this Report, signed by the person or persons responsible for the design and execution of the work, shall be lodged with the local authority.

3. FIRE RESISTANCE.—(a) Floors, walls, and other constructions in steel and concrete formed of incombustible materials prevent the spread of fire in varying degrees according to the composition of the concrete, the thickness of the parts, and the amount of cover given to the metal.

(b) Experiment and actual experience of fires show that concrete in which limestone is used for the aggregate is disintegrated, crumbles and loses coherence when subjected to very fierce fires, and that concretes of gravel or sandstones also suffer, but in a rather less degree.* The metal reinforcement in such cases generally retains the mass in position, but the strength of the part is so much diminished that it must be renewed. Concrete in which coke-breeze, cinders, or slag forms the aggregate is only superficially injured, does not lose its strength, and in general may be repaired. Concrete of broken brick suffers more than cinder concrete and less than gravel or stone concrete.

(c) The material to be used in any given case should be governed by the amount of fire resistance required as well as by the cheapness of, or the facility of procuring, the aggregate.

(d) Rigidly attached web members, loose stirrups, bent-up rods, or similar means of connecting the metal in the lower or tension sides of beams or floor slabs (which sides suffer most injury in case of fire) with the upper or compression sides of beams or slabs not usually injured are very desirable.

(e) In all ordinary cases a cover of $\frac{1}{2}$ inch on slabs and 1 inch on beams is sufficient. It is undesirable to make the covering thicker. All angles should be rounded or splayed to prevent spalling off under heat.

(f) More perfect protection to the structure is required under

* The smaller the aggregate the less the injury.

very high temperature, and in the most severe conditions it is desirable to cover the concrete structure with fire-resisting plastering which may be easily renewed. Columns may be covered with coke-breeze concrete, terra-cotta, or other fire-resisting facing.

MATERIALS.

4. *Cement*.—Only Portland cement complying with the requirements of the specification adopted by the British Engineering Standards Committee should be employed; in general the slow-setting quality should be used. Every lot of cement delivered should be tested, and in addition the tests for soundness and time of setting, which can be made without expensive apparatus, should be applied frequently during construction. The cement should be delivered on the work in bags or barrels bearing the maker's name and the weight of the cement contained.

5. *Sand*.—The sand should be composed of hard grains of various sizes up to particles which will pass a $\frac{1}{4}$ -inch square mesh, but of which at least 75 per cent. should pass $\frac{1}{2}$ -inch square mesh. Fine sand alone is not so suitable, but the finer the sand the greater is the quantity of cement required for equal strength of mortar. It should be clean and free from ligneous, organic, or earthy matter. The value of sand cannot always be judged from its appearance, and tests of the mortar prepared with the cement and the sand proposed should always be made. Washing sand does not always improve it, as the finer particles which may be of value to the compactness and solidity of the mortar are carried away in the process.

6. *Aggregate*.—The aggregate, consisting of gravel, hard stone, or other suitable material,* should be clean and preferably angular, varied in size as much as possible between the limits of size allowed for the work. In all cases material which passes a sieve of a quarter-inch square mesh should be reckoned as sand. The maximum allowable size is usually $\frac{3}{4}$ inch. The maximum limit must always be such that the aggregate can pass between the reinforcing bars and between these and the centering. The sand should be separated from the gravel or broken stone by screening before the materials are measured.

* Coke breeze, pan breeze or boiler-ashes ought not to be used for reinforced concrete. It is advisable not to use clinker or slag, unless the material is selected with great care.

7. *Proportions of the Concrete.*—In all cases the proportions of the cement, sand, and aggregate should be separately specified in volumes. The amount of cement added to the aggregate should be determined on the work by weight. The weight of a cubic foot of cement for the purpose of proportioning the amount of cement to be added may be taken at 90 lbs. As the strength and durability of reinforced concrete structures depend mostly on the concrete being properly proportioned, it is desirable that in all important cases tests should be made as described herein with the actual materials that will be used in the work before the detailed designs for the work are prepared.

In no case should less dry cement be added to the sand when dry than will suffice to fill its interstices, but subject to that the proportions of the sand and cement should be settled with reference to the strength required, and the volume of mortar produced by the admixture of sand and cement in the proportions arranged should be ascertained.*

The interstices in the aggregate should be measured and at least sufficient mortar allowed to each volume of aggregate to fill the interstices and leave at least 10 per cent. surplus.

For ordinary work a proportion of one part of cement to two parts sand will be found to give a strong, practically watertight mortar, but where special watertightness or strength is required the proportion of cement must be increased.

8. *Metal.*—The metal used should be steel having the following qualities :—

(a) An ultimate strength of not less than 60,000 lbs. per square inch.

(b) A yield point of not less than 32,000 lbs. per square inch.

(c) It must stand bending cold 180° to a diameter of the thickness of pieces tested without fracture on outside of bent portion.

(d) In the case of round bars the elongation should not be less than 22 per cent., measured on a gauge-length of eight diameters. In the case of bars over one inch in diameter the elongation may be measured on a gauge-length of four diameters, and should then be not less than 27 per cent.

* For convenience on small works the following figures may be taken as a guide, and are probably approximately correct for medium siliceous sand :—

Parts Cement.	Parts Sand.	Parts Mortar.	Parts Cement.	Parts Sand.	Parts Mortar.		
1	+	$\frac{1}{2}$ =	1.20	1	+	2 =	2.85
1	+	1 =	1.50	1	+	$2\frac{1}{2}$ =	2.70
1	+	$1\frac{1}{2}$ =	1.90	1	+	3 =	3.00

For other sectional material the tensile and elongation tests should be those prescribed in the British Standard Specification for Structural Steel. If hard or special steel is used, it must be on the architect's or engineer's responsibility and to his specification.

Before use in the work the metal must be clean and free from scale or loose rust. It should not be oiled, tarred, or painted.

Welding should in general be forbidden; if it is found necessary, it should be at points where the metal is least stressed, and it should never be allowed without the special sanction of the architect or engineer responsible for the design.

The reinforcement ought to be placed and kept exactly in the positions marked on the drawings, and, apart from any consideration of fire resistance, ought not to be nearer the surface of the concrete at any point than 1 inch in beams and pillars and $\frac{1}{2}$ inch in floor slabs or other thin structures.

9. *Mixing: General.*—In all cases the concrete should be mixed in small batches and in accurate proportions, and should be laid as rapidly as possible. No concrete which has begun to set should be used.

Hand-mixing.—When the materials are mixed by hand they are to be turned over dry and thoroughly mixed on a clean platform until the colour of the cement is uniformly distributed over the aggregate.

Machine Mixing.—Whenever practicable the concrete should be mixed by machinery.

10. *Laying.*—The thickness of loose concrete that is to be punned should not exceed three inches before punning, especially in the vicinity of the reinforcing metal. Special care is to be taken to ensure perfect contact between the concrete and the reinforcement, and the punning to be continued till the concrete is thoroughly consolidated. Each section of concreting should be as far as possible completed in one operation*; when this is impracticable, and work has to be recommenced on a recently laid surface, it is necessary to wet the surface; and where it has hardened it must be hacked off, swept clean, and covered with a layer of cement mortar $\frac{1}{2}$ inch thick, composed of equal parts of cement and sand. Work should not be carried on when the temperature is below 34° Fahr. The concrete when laid should be protected from the action of frost, and shielded against too rapid drying from exposure

* In particular the full thickness of floor slab should be laid in one operation.

to the sun's rays or winds, and kept well wetted. All shaking and jarring must be avoided after setting has begun. The efficiency of the structure depends chiefly on the care with which the laying is done.

Water.—The amount of water to be added depends on the temperature at the time of mixing, the materials, and the state of these, and other factors, and no recommendation has therefore been made. Sea-water should not be used.

11. *Centering or Casing.*—The centering must be of such dimensions, and so constructed, as to remain rigid and unyielding during the laying and punning of the concrete. It must be so arranged as to permit of easing and removal without jarring the concrete. Provision should be made wherever practicable for splaying or rounding the angles of the concrete. Timber when used for centering may be advantageously limewashed before the concrete is deposited.

12. *Striking of Centres.*—The time during which the centres should remain up depends on various circumstances, such as the dimensions or thickness of the parts of the work, the amount of water used in mixing, the state of the weather during laying and setting, etc., and must be left to the judgment of the person responsible for the work. The casing for columns, for the sides of beams, and for the soffits of floor slabs not more than 4 feet span must not be removed under eight days; soffits of beams and of floors of greater span should remain up for at least fourteen days, and for large span arches for at least twenty-eight days. The centering of floors in buildings which are not loaded for some time after the removal of same may be removed in a short time; the centering for structures which are to be used as soon as completed must remain in place much longer. If frost occurs during setting, the time should be increased by the duration of the frost.

13. *Testing.*—Before the detailed designs for an important work are prepared, and during the execution of such a work, test pieces of concrete should be made from the cement, and aggregate to be used in the work, mixed in the proportions specified. These pieces should be either cubes of not less than 4 inches each way, or cylinders not less than 6 inches diameter, and of a length not less than the diameter. They should be prepared in moulds, and punned as described for the work. Not less than four cubes or cylinders should be used for each test, which should be made twenty-eight days after moulding. The pieces should be tested

by compression, the load being slowly and uniformly applied. The average of the results should be taken as the strength of the concrete for the purposes of calculation, and in the case of concrete made in proportions of 1 cement, 2 sand, 4 hard stone, the strength should not be less than 1,800 lbs. per square inch. Such a concrete should develop a strength of 2,400 lbs. at 90 days.

Loading tests on the structure itself should not be made until at least two months have elapsed since the laying of the concrete. The test load should not exceed one and a half times the accidental load. Consideration must also be given to the action of the adjoining parts of the structure in cases of partial loading. In no case should any test load be allowed which would cause the stress in any part of the reinforcement to exceed two-thirds of that at which the steel reaches its elastic limit.

METHODS OF CALCULATION.

DATA.

1. *Loads*.—In designing any structure there must be taken into account:—

- (a) The weight of the structure.
- (b) Any other permanent load, such as flooring, plaster, etc.
- (c) The accidental or superimposed load.
- (d) In some cases also an allowance for vibration and shock.

Of all probable distributions of the load, that is to be assumed in calculation which will cause the greatest straining action.

(i.) The weight of the concrete and steel structure may be taken at 150 lbs. per cubic foot.

(ii.) In structures subjected to very varying loads and more or less vibration and shock, as, for instance, the floors of public halls, factories, or workshops, the allowance for shock may be taken equal to half the accidental load. In structures subjected to considerable vibration and shock, such as floors carrying machinery, the roofs of vaults under passage ways and courtyards, the allowance for shock may be taken equal to the accidental load.

(iii.) In the case of columns or piers in buildings, which support three or more floors, the load at different levels may be estimated in this way. For the part of the roof or top floor supported, the full accidental load assumed for the floor and roof is to be taken. For the next floor below the top floor 10 per cent. less than the accidental load assumed for that floor. For the next floor 20 per cent. less,

and so on to the floor at which the reduction amounts to 50 per cent. of the assumed load on the floor. For all lower floors the accidental load on the columns may be taken at 50 per cent. of the loads assumed in calculating those floors.*

BEAMS.

2. *Spans*.—These may be taken as follows:—For beams the distance from centre to centre of bearings; for slabs supported at the ends, the clear span + the thickness of slab; for slabs continuous over more than one span, the distance from centre to centre of beams.

3. *Bending moments*.—The bending moments must be calculated on ordinary statical principles, and the beams or slabs designed and reinforced to resist these moments. In the case of beams or slabs continuous over several spans or fixed at the ends, it is in general sufficiently accurate to assume that the moment of inertia of the section has a constant value.

Where the maximum bending moments in beams or floor slabs continuous over three or more equal spans and under uniformly distributed loads, are not determined by exact calculation, the bending moments should not be taken less than $+\frac{wl^2}{12}$ at the centre of the span and $-\frac{wl^2}{12}$ at the intermediate supports.

When the spans are of unequal lengths, when the beam or slab is continuous over two spans only, or when the loads are not uniformly distributed, more exact calculations should be made.

If the bending moments are calculated by the ordinary theory of continuous beams, it should be remembered that the supports are usually assumed level, and if this is not the case, or the supports sink out of level, the bending moments are altered.

4. *Stresses*.—The internal stresses are determined, as in the case of a homogeneous beam, on these approximate assumptions:—

(a) The coefficient of elasticity in compression of stone or gravel concrete, not weaker than 1 : 2 : 4, is treated as constant and taken at one-fifteenth of the coefficient of elasticity of steel.

$$\begin{aligned} \text{Coefficient for concrete} &= E_c = \overset{\text{lbs. per sq. in.}}{2,000,000} \\ \text{,, ,, steel} &= E_s = 30,000,000 \\ &\frac{E_s}{E_c} = 15. \end{aligned}$$

* In the case of many warehouses and buildings containing heavy machines it is desirable not to make any reduction of the actual loads.

It follows that at any given distance from the neutral axis, the stress per square inch on steel will be fifteen times as great as on concrete.

(b) The resistance of concrete to tension is neglected, and the steel reinforcement is assumed to carry all the tension.

(c) The stress on the steel reinforcement is taken as uniform on a cross-section, and that on the concrete as uniformly varying. In the case of steel of large section it may be necessary to consider the stress as varying across the section.

5. *Working stresses.*—If the concrete is of such a quality that its crushing strength is 1800 lbs. per square inch after twenty-eight days as determined from the test cubes made in accordance with Clause 13, and if the steel has a tenacity of not less than 60,000 lbs. per square inch, the following stresses may be allowed:—

Concrete, in compression in beams subjected to bending	600
Concrete in columns under simple compression . . .	600
Concrete in shear in beams	60
Adhesion * or grip of concrete to metal	100
Steel in tension	16,000
Steel in compression	fifteen times the stress in the surrounding concrete
Steel in shear	12,000

When the proportions of the concrete differ from those stated above, the stress allowed in compression on the concrete may be taken at one-third the crushing stress of the cubes at twenty-eight days as determined above.

If stronger steel is used, the allowable tensile stress may be taken at one-half the stress at the yield point of the steel, but in no case should it exceed 20,000 lbs. per square inch.

BEAMS WITH SINGLE REINFORCEMENT.

Beams with single reinforcement can be divided into three classes.

(a) Beams of T form in which the neutral axis falls outside the slab.

* It is desirable that the reinforcing rods should be so designed that the adhesion is sufficient to resist the shear between the metal and concrete. Precautions should in every case be taken by splitting or bending the rod ends or otherwise to provide additional security against the sliding of the rods in the concrete.

(b) Beams of T form in which the neutral axis falls within the slab.

(c) Rectangular beams.

The equations found for (a) are general equations, from which the equations for (b) and (c) may be deduced.

In the calculation of all beams, the area upon which the ratio of tensile reinforcement is taken is considered as a rectangle of breadth equal to the greatest breadth of the beam and of depth equal to the greatest effective depth of the beam.

In designing beams where the rib is monolithic with a slab, the beam may be considered to be of T form. The slab must first be calculated and designed having its own reinforcing bars transverse to the rib. The whole of the slab cannot in general be considered to form part of the upper flange of the T beams. The width b of the upper flange may be assumed to be not greater than one-third the span of the beams, or more than three-fourths of the distance from centre to centre of the reinforcing ribs or more than fifteen times the thickness of slab. The width b_1 of the rib should not be less than one-sixth of the width b of the flange.

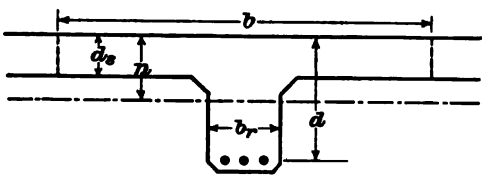

FIG. 1.

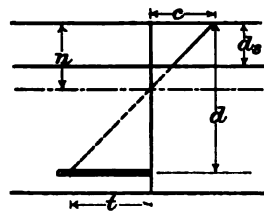

FIG. 2.

(a) Beams of T section where the neutral axis falls outside the slab.

In this case the small compression in the rib between the underside of the slab and the neutral axis may be neglected. In a homogeneous beam the stresses are proportional to the distances from the neutral axis. In a discrete beam, such as a beam of concrete and steel, on account of the greater rigidity of steel, at a given distance from the neutral axis the stress in the steel will be m times as great as in concrete.

Hence

$$\frac{mc}{t} = \frac{n_1 d}{d(1 - n_1)} = \frac{n_1}{1 - n_1}$$

$$\frac{c}{t} = \frac{n_1}{m(1 - n_1)}$$

The mean compressive stress in the flange is

$$\begin{aligned} \frac{1}{2}c + c\left(\frac{n - d_c}{n}\right) &= \frac{c}{2} \cdot \frac{2n - d_c}{n} \\ &= c\left(1 - \frac{s_c}{2n}\right) \end{aligned}$$

and the total compression is

$$bd \frac{c}{2} \cdot \frac{2n - d_c}{n}.$$

The area of reinforcement $A_s = rbd$

and the total tension is

$$trbd.$$

Equating total compression and total tension

$$\begin{aligned} bd \frac{c}{2} \cdot \frac{2n - d_c}{n} &= trbd \\ \frac{c}{t} &= \frac{2rn_c}{(2n_c - s_c)s_c} \end{aligned}$$

Equating these two values for $\frac{c}{t}$

$$\begin{aligned} \frac{n_c}{m(1 - n_c)} &= \frac{2rn_c}{(2n_c - s_c)s_c} \\ n_c &= \frac{s_c^2 + 2mr}{2(s_c + mr)}. \end{aligned}$$

The value of the lever arm is

$$\begin{aligned} d - \frac{d_c}{3} \cdot \frac{3n - 2d_c}{2n - d_c} \\ = d \left\{ 1 - \frac{s_c}{3} \left(\frac{3n_c - 2s_c}{2n_c - s_c} \right) \right\}. \end{aligned}$$

The compressive resistance moment of the beam is

$$R_c = cbd d_c \frac{(s_c^3 + 4mrs_c^2 - 12mrs_c + 12mr)}{6(s_c^2 + 2mr)}.$$

The tensile resistance moment is

$$R_t = tbd^2 \frac{(s_c^3 + 4mrs_c^2 - 12mrs_c + 12mr)}{6m(2 - s_c)}.$$

To obtain stresses in the concrete and steel equal to c and t respectively r must have a value

$$\frac{2mcs_c - mcs_c^2 - ts_c^2}{2mt}$$

When r exceeds the value given by this equation the equation to R_c must be used in determining the moment of resistance. When r is less than the above value the equation to R_t must be used.

The following equation gives the value for r which causes the neutral axis to be at the underside of the slab :—

$$r = \frac{s_1^2}{2m(1 - s_1)}$$

(b) When the neutral axis falls within the slab, or is at the bottom edge of the slab, the equations for values of n , R_c , and R_s can be simplified and become

$$n = \sqrt{(m^2 r^2 + 2mr)} - mr.$$

$$R_c = \frac{cbd^2 n}{2} \left(1 - \frac{n}{3}\right).$$

$$R_s = trbd^2 \left(1 + \frac{n}{3}\right).$$

To obtain stresses in the concrete and steel equal to c and t respectively

$$r \text{ must equal } \frac{mc^2}{2t(mc + t)}.$$

(c) For rectangular beams, not of T form, the equations given for T beams under (b) apply.

The ratio of reinforcement may be taken on any other suitable sectional area if the formulæ are modified in accordance.

Slabs supported or fixed on more than two sides.

It does not appear that there is either a satisfactory theory or trustworthy experiments from which the strength of rectangular slabs supported or fixed on all four edges can be determined. [See Appendices for a statement of some rules which have been used in determining the strength of slabs.]

SHEAR REINFORCEMENT.

It is always desirable to provide reinforcement to resist the shearing and diagonal tension stresses in reinforced concrete beams. The diagonal tension stresses depend on the vertical and horizontal shear and also on the longitudinal tension at the point considered. As the longitudinal tension in the concrete at any given point is very uncertain, the amount and direction of the diagonal tension cannot be exactly determined.

It is the general practice to determine the necessary reinforcement by taking the vertical and horizontal shearing only into consideration.

The following equations may be used to determine the necessary resistance to shearing.

When S , the total shear in lbs. at a vertical section, does not exceed $60ba$, no shear reinforcement is required.*

When S exceeds $60ba$, vertical shear members may be provided to take the excess and proportioned by the following rule:—

$$\frac{A_s \cdot s \cdot a}{p} = S - 60ba$$

or

$$A_s = \frac{(S - 60ba)p}{as}$$

where s , is the unit resistance of the steel to shearing, and p is the pitch, or distance apart of the vertical shear members or groups of shear members, of area A_s .

In the case of **T** beams, b_s should be substituted for b .

In important cases, when extra security is required, the resistance of the concrete to shear, represented by $60ba$, should be disregarded.

When the shear members are inclined at an angle of about 45° to the horizontal, the area A_s may be decreased in the proportion of $\frac{1}{\sqrt{2}}$.

These equations, though based on somewhat uncertain assumptions, give reasonable results. But experience shows that:

(a) In general, floor slabs require no special reinforcement against shearing, and that the bending up of alternate bars near the end is sufficient.

(b) In beams, especially in **T** beams, shearing reinforcement should be provided at distances apart not exceeding the depth of the beam.

(c) It is desirable to bend up one or more of the bars of the tension reinforcement near the supports. When bent at an angle of about 45° the effect of this may be taken into account in the manner set out above; when bent at a small angle to the horizontal the effect is very indeterminate.

(d) As the resistance of the shear members to the pull depends on the adhesion, and the anchorage at the ends, it is desirable to use bars of small diameter, and to anchor the stirrups at both their ends. In all cases the stirrups must be taken well beyond the centre of compression.

* The value of Sp is shown in the appendix to be $\frac{B_1 - B_2}{a}$.

PILLARS AND PIECES UNDER DIRECT THRUST.

DEFINITIONS.

The length is to be measured between lateral supports (neglecting ordinary bracketing).

The effective diameter of a pillar means the least width, and should be measured to the outside of the outermost vertical reinforcement.

The effective area of a pillar means the area contained by the outermost lateral reinforcement, and should be measured to the outside of the outermost vertical reinforcement.

LOADING AND LENGTH OF PILLARS.

If the load is strictly axial the stress is uniform on all cross-sections.

Lateral bending of the pillar as a whole is not to be feared provided:

(a) That the ratio of length to least outside diameter does not exceed 18.

(b) That the stress on the concrete does not exceed the permissible working stress for the given pillar.

(c) That the load be central.

(d) That the pillar be laterally supported at the top and base.

CONSTRUCTION.

Lateral reinforcement properly disposed raises the ultimate strength and increases the security against sudden failure, by preventing the lateral expansion of the concrete and the sudden disruption of the pillar.

Practical considerations lead to the addition of longitudinal bars, and the formation of an enveloping network of steel.

The total cross-sectional area of the vertical reinforcement should never be less than 0·8 per cent. of the area of the hooped core.

There should be at least six vertical bars when curvilinear laterals are used, and four for square pillars having rectilinear laterals.

In the case of rectangular pillars in which the ratio between the greater and the lesser width (measured to the outside of the vertical bars) exceeds one and a half, the cross-section of the pillars should be subdivided by cross ties; and the number of vertical bars

should be such that the distance between the vertical bars along the longer side of the rectangle should not exceed the distance between the bars along the shorter side of the rectangle.

The most efficient disposition of the lateral reinforcement would appear to be in the form of a cylindrical helix, the pitch or distance between the coils being small enough to resist the lateral expansion of the concrete.

Jointed circular hoops as ordinarily made are apparently not quite so efficient.

Rectilinear ties are still less adapted to resist the lateral or radial expansion of a highly stressed core.

The volume of curvilinear laterals should never be less than 0.5 per cent. of the volume of hooped core.

The diameter of rectilinear laterals should not be less than $\frac{3}{16}$ of an inch.

STRENGTH.

The amount of the increase of strength in hooped pillars depends upon

1. The *form* of hooping (whether curvilinear or rectilinear, etc.).
2. The *spacing* or distance between the hoops.
3. The *quantity* of hooping relative to the quantity of concrete in the core of the pillar.
4. The *quality of the concrete*.

Consequently the increase of strength may be shown to be equal to the product of the four factors (*u.f.s.r.*).

u = the *ultimate* compressive stress on concrete not hooped (per unit of area).

f = a *form* factor or constant which will vary according to whether the hooping is curvilinear or rectilinear, etc.

s = *Spacing* factor or constant which will vary with the pitch of the laterals.

V_h = *Volume* of hooped reinforcement in cubic inches.

V = *Volume* of hooped core in cubic inches.

$r = V_h/V$ = the *ratio* of volumes, i.e. the *ratio* of the volume of *helical* or horizontal reinforcement to the volume of hooped core.

The *ultimate* compressive stress on concrete *not hooped* being = u , and the increase of strength due to hooping being

u.f.s.r. :

the total resistance of the hooped material per unit of area will then be

$$= u + u.f.s.r$$

$$= u(1 + f.s.r).$$

Let c_p = the working compressive stress on a prism of concrete (not hooped) = $W_p u$

$$W_p = \text{the working factor} = c_p/u.$$

Then the safe compressive stress on the hooped core = c , where

$$c = W_p u(1 + f.s.r)$$

$$= c_p(1 + f.s.r).$$

The values of f , s and their product may be obtained from the following table:—

Form of lateral reinforcement.	Form factor = f .	Spacing of laterals in terms of diameter of hooped core.	Spacing factor = s .	Value of fs .
Helical	1	0.2 d	32	32
"	1	0.3 d	24	24
"	1	0.4 d	16	16
Circular hoops ...	0.75	0.2 d	32	24
" " ...	0.75	0.3 d	24	18
" " ...	0.75	0.4 d	16	12
Rectilinear	0.5	0.2 d	32	16
"	0.5	0.3 d	24	12
"	0.5	0.4 d	16	8
"	0.5	0.5 d	8	4
"	0.5	0.6 d	0	0

Let p = the pitch of the laterals in inches (*i.e.* the axial spacing of the laterals),

d = the effective diameter of the hooped core in inches.

The spacing factor should not be taken at more than 32, even if p is less than 0.2 d , but intermediate values of the spacing factor may be obtained from the equation

$$s = 48 - 80 \frac{p}{d}$$

It will be seen from the above table that the advantage of hooping disappears with an increase in the spacing of the laterals, irrespective of the volume of hooping or the value of r .

Before the safe stress on the hooped core can be obtained it will be necessary to give values to W_f and u . A table for this purpose will be found below.

The value of the working compressive stress on the concrete of the hooped core having been obtained, the maximum permissible pressure or load may be obtained from the equation

$$P = c\{A + (m - 1)A_v\},$$

where A = the effective area of the pillar,

$$m = \frac{E_s}{E_c} = \text{modular ratio.}$$

A_v = area of vertical reinforcement,

P = total safe pressure on pillar.

WORKING STRESSES.

A safety factor of 4 at 90 days is recommended for all pillars.

The following table of working stresses is suitable if good materials are used, and is based on the assumption that test cubes have at least the strength given at the periods stated:—

TABLE SHOWING THE VALUE OF u AND c_p FOR PILLARS.

Proportions of concrete measured by volume.	Pounds of cement to 13½ cubic feet of sand and 27 cubic feet of shingle or broken stones.	Value of u at 28 days in pounds per square inch.	Value of u at 90 days in pounds per square inch.	Value of c_p at 90 days in pounds per square inch (safety factor = 4) (working factor = 1/4).
1 : 2 : 4	610	1800	2400	600
1 : 1½ : 3	810	2100	2800	700
1 : 1 : 2	1220	2700	3600	900

It is assumed that the tests of the strength of the concrete are made on unrammed cubes of the same consistency as the concrete used on the work.*

LIMITATIONS OF STRESS ON PILLARS.

The following limits of stress should be observed in pillars:

(a) The stress on the metal reinforcement (*i.e.* the value of

* The limit of 2400 lbs. per square inch given in the previous report of the Committee was adopted on the assumption that the cubes would be rammed with iron rammers under laboratory conditions.

m.c) should not exceed 0.5 of the yield point of the metal ;

- (b) Whatever the percentage of lateral reinforcement the working stress on the concrete of pillars should not exceed $(0.34 + 0.32f) u$, where

f = form factor

u = ultimate crushing resistance of the concrete.

Form of laterals.	Form factor.	Value of $(0.34 + 0.32f)u$.
Rectilinear	0.5	0.5 <i>u</i>
Independent circular hoops	0.75	0.58 <i>u</i>
Helical	1.00	0.66 <i>u</i>

If these limits are adopted, the working stress on hooped concrete will always fall within the "limit of continued endurance" for plain concrete.

. PILLARS ECCENTRICALLY LOADED.

If a pillar initially straight is loaded eccentrically, as when a beam rests on a bracket attached to the pillar, it may be regarded as fixed at the base and free at the loaded end. Then it must bend in the plane passing through the load, the deflection at the top being *d_n*. Let *e* be the eccentricity of the load measured from the centre of the pillar when straight. Then the bending moment at the base of the pillar is *W(d_n + e)*. But it is known that *d_n* will be small compared with *e*, provided that *W* is small compared with $2EI/l^2$, and this will be the case in such conditions as are likely to occur in designing concrete pillars. Then the bending moment may be taken as *We*, and the extreme "fibre" stress at the edge of the base of the pillar, treating it as homogeneous, will be

$$f = W \left(\frac{1}{A} \pm \frac{e}{S_m} \right)$$

very nearly, where *A* is the whole section of the pillar, and *S_m* the section modulus relatively to an axis through the centre of gravity and at right angles to the plane of bending.

In dealing with reinforced pillars which are not homogeneous, it is convenient to substitute for the actual section of the pillar what may be termed the equivalent section, or section of concrete equivalent in resistance to the actual pillar. If *A* is the effective area of

section of the pillar (including the area of reinforcement), and A_v is the area of vertical reinforcement, then the equivalent section is

$$A_e = A + (m - 1)A_v.$$

If d is the depth of the section in the plane of bending, the Inertia moment relatively to the neutral axis can be expressed in the form

$$I = nAd^3,$$

and the section modulus in the form $S_m = 2nAd$ (see Appendix V.).

It is desirable in pillars that there should be no tension, and generally when the vertical load is considerable there is none. Cases in which the eccentricity is so great that there is tension must be treated by the methods applicable to beams if it is made a condition that the steel carries all the tension. In the following cases it is assumed that there is no tension.

Case I. Pillar of Circular Section, Reinforcements Symmetrical and Equidistant from the Neutral Axis.—Let m be the modular ratio = E_s/E_c , A the effective cross-section of the column in square inches, A_v the area of vertical reinforcement in square inches, d the diameter of the pillar, e the distance between the vertical reinforcing bars perpendicular to the neutral axis. Then the equivalent section is

$$A_e = A + (m - 1)A_v,$$

and the section modulus is (Appendix V.)

$$S_m = \frac{1}{8}Ad + \frac{1}{2}(m - 1)A_v \frac{d^2}{d}.$$

The stress at the edges of the section can then be calculated by the general equation

$$f = W \left(\frac{1}{A} \pm \frac{e}{S_m} \right)$$

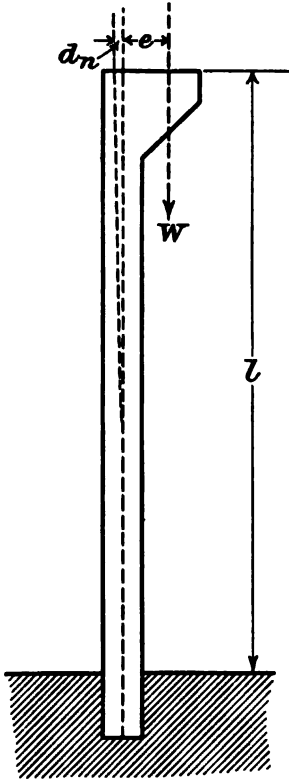

where e is the eccentricity of the load in inches, and W the weight or load in pounds. The greater value of stress must not exceed the safe stress stated above.

Case II. Rectangular Section with Reinforcement Symmetrical and Equidistant from the Neutral Axis. Using the same notation as in the last case, d being now the *depth* of the section in the plane of bending, the section modulus is (Appendix V.)

$$S_m = \frac{1}{8}Ad + \frac{1}{2}(m-1)A_v \frac{d_r^2}{d},$$

and the stresses are given by the same equation as in the previous case.

Case III. Column of Circular Section with Reinforcing Bars arranged in a Circle.—Using the same notation as in Case I., h , being the diameter of the circle of reinforcing bars, the section modulus is (Appendix V.)

$$S_m = \frac{1}{8}Ad + \frac{1}{2}(m-1)A_v \frac{d_r^2}{d},$$

and the stresses are given by the same equation as in Case I.

(c) *Long Pillars axially loaded.*

For pillars more than 18 diameters in length there is risk of lateral buckling of the pillar as a whole. The strength of such pillars would be best calculated by Gordon's formula, but there are no experiments on long pillars by which to test the values of the constants for a concrete or concrete and steel pillar. There does not seem, however, to be any probability of serious error if the total load is reduced in a proportion inferred from Gordon's formula to allow for the risk of buckling.

Let, as before, A = the *area* of the column in inches, A_v = the *area* of *vertical* reinforcement. Then $A_g = A + (m-1)A_v$ is the equivalent section. Let N be the *numerical* constant in the equation, $I = NA^3$ (Appendix V.), and d the least diameter of the pillar.

Then for a pillar fixed in direction at both ends Gordon's formula is

$$\frac{W}{Au} = \frac{1}{1 + \frac{l^2}{C_1 N d^2}} = \frac{1}{1 + C_2},$$

so that the pillar will carry less than a short column of the same

dimensions in the ratio of $1 + C_2$ to 1, or, in other words, the column will be safe if calculated as a short column, not for the actual weight or pressure P , but for a weight or pressure = $(1 + C_2)W$.

The constant C_1 has not been determined experimentally for reinforced long columns. But its probable value is

$$C_1 = \frac{4\pi^2 E_c}{u}$$

where u is the *ultimate* crushing stress. Putting $E_c = 2,000,000$ and $u = 2500$, then $C_1 = 32,000$. Looking at the well-understood uncertainty of the rules for long columns, a very exact calculation is useless. Some values of N for ordinary types of column are given in Appendix V. Taking these values, the following are the values of $1 + C_2$:—

VALUES OF $1 + C_2$.

$\frac{l}{d}$	Case I.	Case II.	Case III.
	$N = 0.098.$	$N = 0.075.$	$N = 0.0646.$
20	1.13	1.17	1.19
25	1.20	1.26	1.30
30	1.29	1.38	1.44

The differences of $1 + C_2$ for considerable differences of N are not very great. In any case N can be found by the method in the Appendix with little trouble.

In the case of columns fixed at one end and rounded or unfixed at the other, $2C_2$ must be substituted for C_2 . If the column is rounded at both ends, $4C_2$ must be substituted for C_2 .

APPENDIX VII.

BACH'S THEORY OF THE RESISTANCE OF FLAT SLABS SUPPORTED ON ALL EDGES AND UNIFORMLY LOADED.

By W. C. UNWIN.

The experiments of Professor Bach show that a flat square slab supported all round fractures along a diagonal, and the greatest stress is therefore on the diagonal section. It is the same apparently

with rectangular slabs, though the evidence is not quite so clear. But if a diagonal fracture is assumed a very simple theory gives the stress.

. Let the figure represent a rectangular slab with sides equal to $2a$ and $2b$ in inches. Let the diagonal $BD = d$; and the thickness of the slab = h in inches. Draw AE perpendicular to BD and let $AE = c$ in inches. Draw FG bisecting the sides, then GF bisects AE . Let W be the total load on the slab in pounds.

The forces acting on the left of the diagonal section BD are the weight $\frac{1}{2}W$ of the half slab acting at $\frac{1}{3}c$ from BD and the supporting forces acting at G and F , which have a resultant $\frac{1}{2}W$, acting at $\frac{1}{3}c$ from BD .

Since $cd = 4ab,$
 $d = 2\sqrt{(a^2 + b^2)}$
 $c = \frac{2ab}{\sqrt{(a^2 + b^2)}}$

The bending moment on the diagonal section BD is

$$= \frac{W}{2} \left(\frac{c}{2} - \frac{c}{3} \right) = \frac{Wc}{12} = \frac{Wab}{6\sqrt{(a^2 + b^2)}}$$

The intensity of tensile or compressive stress is

$$f = \frac{6M}{dh^2} = \frac{Wab}{2h^2(a^2 + b^2)}$$

This may be put in the form

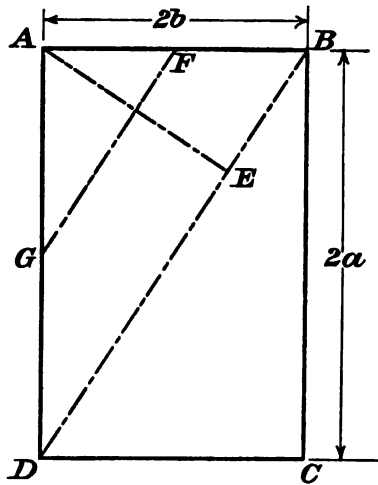

$$f = \frac{W}{h^2} \cdot \frac{\frac{a}{b}}{\left(\frac{a^2}{b^2} + 1 \right)}$$

$$\frac{a}{b} =$$

1

1.5

1

$$f =$$

$$0.25 \frac{W}{h^2}$$

$$0.23 \frac{W}{h^2}$$

$$0.20 \frac{W}{h^2}$$

It would seem that if Bach's formula is to be used in calculating slabs, the reinforcing rods should be perpendicular to the diagonals of the rectangle.

APPENDIX VIII.

COMPARISON OF THE RESULTS GIVEN BY VARIOUS RULES FOR THE STRENGTH OF FLAT RECTANGULAR SLABS SUPPORTED ON ALL EDGES AND UNIFORMLY LOADED.

By WILLIAM DUNN.

The theories of Professor Grashof and of Professor Rankine assume that the maximum bending stress on the slab is at the centre, where there are two principal stresses on planes normal to each other, these planes coinciding with the major and minor axes of the slab.

The stress on the plane formed by the major axis of the slab (which is the greater of the two principal stresses) may be found in a simple manner as follows:—

Let the *length* of the slab = l , and the *breadth* = b (where l is equal to or greater than b).

Calculate the bending moment on the slab (disregarding the end supports) as a beam supported or fixed at the sides only, of a span b under the total load on the slab. Multiply this bending moment by the *factor* for the span b in the following table, to allow for the effect of the end supports. The result is the actual bending moment on the long axis of the slab.

When $\frac{l}{b} =$	Grashof's and Rankine's rule.		French Government rule.	
	$F_b = \frac{l^2}{l^2 + b^2} =$	$F_l = \frac{b^2}{l^2 + b^2}$	$F_b = \frac{1}{1 + 2\frac{b^2}{l^2}}$	$F_l = \frac{1}{1 + 2\frac{l^2}{b^2}}$
1.0	0.50	0.50	0.33	0.33
1.5	0.83	0.16	0.71	0.09
2.0	0.94	0.05	0.89	0.03

The stress on the section formed by the long axis of the slab is found in the usual way by equating this actual bending moment B to the resistance moment R of that section.

Similarly the stress on the plane formed by the minor axis of the slab is found by assuming the slab supported or fixed at the ends (disregarding the effect of the side supports), calculating the bending moment as if the slab were a beam of span l under the total load on the slab. Reduce the bending moment so found by the factor by the span l (F_1 in the table above), and the result is the actual bending moment on the short axis of the slab.

The stress on the section formed by that axis is found as before by equating this B bending moment to the B resistance moment R of that section.

The reasoning by which we find the factors F_1 and F_2 is not entirely satisfactory, and other writers give other values. In the Instructions issued by the French Government to the Ingénieurs des

BENDING MOMENTS (Supported or Fixed).

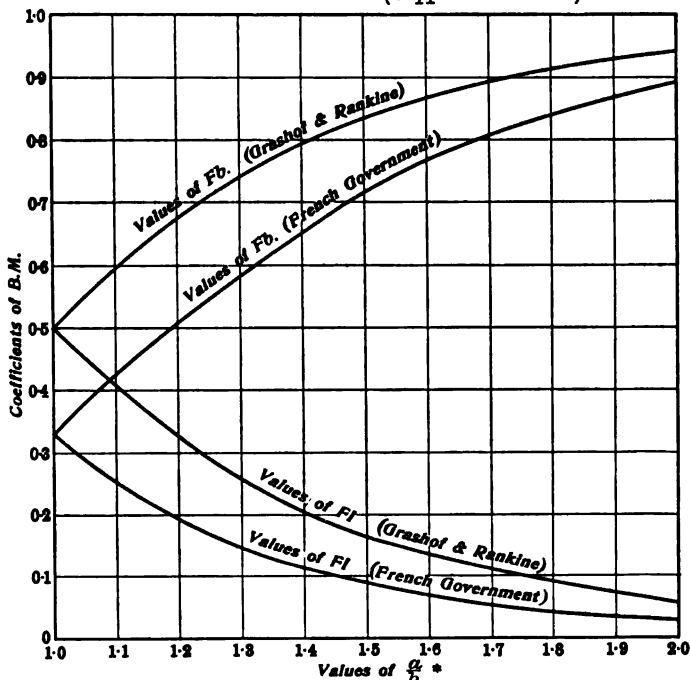

Ponts et Chaussées with the Report of the Ministerial Commission du Ciment Armé the factors adopted give a greater importance to

* Referred to as l/b in the text.—AUTHORS.

the effects of the third and fourth supports. The values of F_1 and F_2 , according to that report, are also given in the table above.

The maximum stresses on the sections as found by the foregoing rules when the slab is supported but not fixed all round are given in the table below, W being the total weight or load uniformly distributed over the slab, d_s the depth of the slab, and f the maximum stress due to bending.

STRESSES (Supported only).

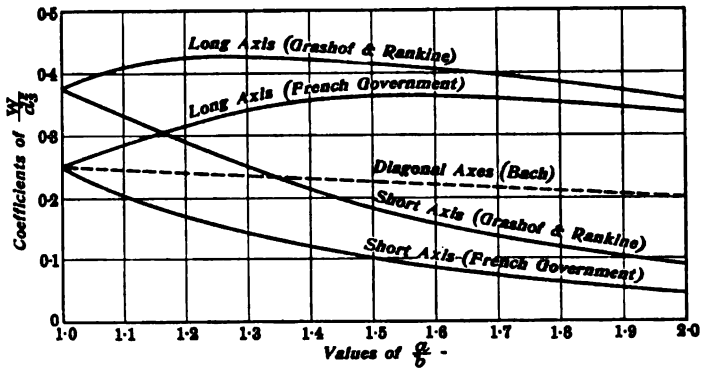

When $\frac{l}{b} =$	Values of f according to Grashof and Rankine.		Values of f according to French Government rule.	
	On long axis.	On short axis.	On long axis.	On short axis.
1.0	$0.375 \frac{W}{d_s^2}$	$0.375 \frac{W}{d_s^2}$	$0.250 \frac{W}{d_s^2}$	$0.250 \frac{W}{d_s^2}$
1.5	$0.416 \frac{W}{d_s^2}$	$0.183 \frac{W}{d_s^2}$	$0.361 \frac{W}{d_s^2}$	$0.101 \frac{W}{d_s^2}$
2.0	$0.352 \frac{W}{d_s^2}$	$0.088 \frac{W}{d_s^2}$	$0.333 \frac{W}{d_s^2}$	$0.045 \frac{W}{d_s^2}$

These results may be more readily compared by the diagram given above.

It is implicitly assumed in the foregoing that the strength to resist bending is the same in both directions, so that the reinforcements longitudinal and transverse should be of equal area and at the same depth from the compressed face: they should be placed parallel to the ends and sides.

The stresses found by Bach's formula are also plotted on the diagram.

INDEX

NOTE.—Page numbers in italics refer to the recommendations of the R.I.B.A. Report, 1911.

- ADHESION**, nature of, 71
—, safe working stress, 74, 312
— stresses, calculation of, in beams, 74, 76
— —, in columns, 109
— —, in reservoirs, 209
— —, in slabs, 198
— to various surfaces, 72
Aggregate, 14, 305, 306
Alternating stress, 22
Anchoring bars, 312
Arch action, of brick over lintels, 187
— — in beams, 83
Arched beams, 183
Assumptions made in theory of resisting moments, 25, 311
- BACH's tests of columns**, 105
— theory for flat slabs, 324
Bars, 10
Beams, bending moments in, 157, 311
—, bent, 183
—, continuous *versus* non-continuous, 4, 5
—, curved or bent sharply, 183
—, rectangular, singly reinforced, 26, 312
— —, doubly reinforced, 40
— T-beams, 38, 312
—, shearing forces in, 156
—, size of, 172, 241
—, spans of, 311
Bending, simple, 26
Bending and direct compression, 61
— — — tension, 47
Bending moments in beams, end bays, 161, 169
— — in beams, at outside column, 171
Bending moments in beams with triangular water load, 210
— — in beams, simple formulæ for, at centre, 165
— — — in beams, simple formulæ for, at support, 169
— — on interior columns, 123
— — on outside columns, 143, 153
— — on slabs, 188, 193, 311
Bends and hooks, 77, 312
Bent beams, 183
Bond. See **ADHESION**
Brick concrete, 15
— piers, modulus of elasticity of, 247
— — and walls as supports, 247
- CAMBER**, 239
Cantilevers, 185
Cement, specification of, 12, 306
—, weight of, 17, 307
Centering, 238, 240, 246, 309
Chimneys, 249
Cinder concrete, 15
Clay in aggregate, 13
Coefficient of elasticity for concrete, 25, 104, 311
— of elasticity for steel, 10, 311
— of expansion with temperature, 10
— of friction, 84
Columns, bending moments on general, 94
—, bending moments on inside columns, 123
—, bending moments on outside columns, 143, 153
—, Considère's formulæ, 98
—, design of long, 110, 323

- Columns, design of short, 97, 317
 —, factor of safety in, 107, 108
 —, footings for, 114
 —, French rules for, 101
 —, lateral reinforcement of, 97, 317
 —, loads on interior, 115, 140, 310
 —, splices in, 113
 —, reinforcement of, 7, 44
 —, tests of, 107, 108, 109
 Compression, reinforcement, 40
 —, simple, 44
 Concentrated loads, moments due to, 167, 168, 170
 Concrete, 1, 15
 —, consistency of, 18, 309
 — cover to reinforcement, 243, 305, 308
 —, effect on strength of alternately wetting and drying, 19
 —, effect on strength of variation of stress, 22
 —, increase of strength with age, 18, 310
 —, proportioning, 16, 307
 —, weight of reinforced, 310
 —, wetness and dryness of, 18
 Conductivity, electrical, 250, 254
 Continuity, effect on bending moment, 157
 Continuous beams *versus* non-continuous, 4, 5
 Contractor, 258
 Corrosion, electrolytic, 254
 Cover of concrete, 78, 243, 305, 308
 Cracks in beams, 82
 — in reservoirs, 203
- DEFLECTION of beams, 179, 180, 193
 Diagonal compression, 180
 — tension, 3, 79, 315
 Distribution bars, 185, 199
 Double reinforcement, 40
 Drawings, 233
- EARTH pressure, formulæ and values for, 219, 225
 — on reservoirs, 204
 Eccentricities of load on columns, 94
 —, determination of, 123, 153
 —, design for, 109, 112, 321
 —, on inside columns, with ends of beams partially restrained, 142
- Economy in cost of slabs, 31
 Elastic limit of steel, 9
 Electrolytic corrosion, 254
 Equivalent beam, 42
 — concrete area, 46
 Expanded metal, 199
 Experimental data referring to beams, 78, 80
 — — — bond, 73
 — — — columns, 105
 — — — modulus of concrete, 104
 Experiments, need for, 253
- FACTOR of safety, 9, 22, 107, 108, 254
 Fatigue of concrete, 24
 Finish, 237
 Fire resistance, 242, 305
 Floors, finish of, 238
 —, loads on, 234
 —, minimum thickness of, 243
 Flues, minimum thickness of, 243
 Footings to columns, 114
 — of retaining walls, 230
 Foundation rafts, 247
 French rules for columns, 101
 — for modular ratio, 26
 Frost, effect on retaining walls, 225
 —, lowest temperature for concreting, 240, 308
- GRIP length, 73
- HAUNCHES, as resisting shear, 88
 —, desirability of, at columns, 109, 147
 —, desirability of, at sharp bends, 186
 Helical reinforcement, 98, 317
 Hooks and bends, 77, 312
- INDENTED bars, 10
- JOISTS, steel, 195
- KAHN bars, 11
- LAPS in column bars, 113
 — in circular reservoirs, 74, 209
 Lightning conductors, 250
 Lintels, 186
 Loads, 310
 — on columns, 234

- Loads on floors, 234
 —, test, 235
- MODULAR ratio, m , 26**
 Modulus of elasticity of concrete, 25,
 104, 311
 — — — steel, 10, 311
- Moment of inertia, calculation of,
 128, 129, 133
 — — — of beams, may be assumed
 constant, 311
- Mortar, cement, and sand, 307
- NAVIER's theorem and bent beams, 186**
 Notation, general, xviii.
 — of Appendix I., 262
 — of R.I.B.A. Report, 301
- PIERS, concrete and brick, 247**
 —, piles for, 248
 Piles, 248
 Pillars, 317
 —, eccentrically loaded, 321
 Pohlmann bar, 12
- QUANTITIES, 245**
- RANKINE, Prof., 326**
 — on earth pressure, 219
 Regulations, Fire Offices Committee,
 242
 —, French, for columns, 101
 —, R.I.B.A., 1911.. 300
- Reinforced concrete, its uses and
 advantages, 1, 2
 Reinforcement in beams, 3
 — in slabs, 198
 — of columns, 7
 — of retaining walls, 228
 —, patent bars, 10
- Reservoirs, 201
 —, circular, 74, 205
 —, rectangular, 210
 —, water towers, 212
- Resisting moments, singly reinforced
 sections, 25, 315
 —, doubly reinforced sections,
 40
 —, T-beams, 38, 314
 —, bending and direct com-
 pression, 61
 —, bending and direct tension,
 47
- Retaining walls, 219
- Reversal of stresses, 22, 23
 R.I.B.A. Report, 1911.. 26, 38, 39,
 73, 111, 300
- SAND, 13**
 Sea water, 309
- Settlement of supports, effect on
 beams, 181, 316
 — slabs, 193, 316
- Shear, nature of stress, 79, 315
 —, resistance of bent-up bars, 81,
 316
 —, resistance of concrete, 80, 180,
 315
 —, resistance of haunches, 88
 —, resistance of stirrups, 86, 316
 —, in beams, 156
 —, in T-beams, 90
- Silos, 23, 58, 247
- Slabs, bending moments on, supported
 two sides, 188, 311
 —, bending moments on, supported
 four sides, 315, 324, 326
 —, reinforcement in, 198
 — supported on R. C. beams, 192,
 194
 — supported on R.S. joists, 192,
 195
 —, shear in, of T-beams, 90
- Slope, definition of, 123
- Sloping slabs, centering to, 246
- Specialist engineer, 256
- Specification, general, 233
 —, aggregate, 14, 305
 —, cement, 12, 306
 —, sand, 13, 306
 —, steel, 8, 307
- Spiral reinforcement in columns, 98,
 317
- Splices to columns, 113
- Steel, 8, 31, 246, 307
- Stirrups, 86, 184, 193, 316
- Strain, 41
- Stress in concrete, bending, 312
 —, compression, 103, 312,
 320
 — in interior columns due to ec-
 centric loading, 130, 136
 — in outside columns due to ec-
 centric loading, 147, 149,
 150
 — in steel, 202, 312
 —, variation in magnitude, as af-
 fecting working value, 22
- Student, notes for, 253

- T-BEAMS**, negative moments at
 centre of span, 162
 —, resisting moment of, 38, 313
 —, shear stresses in slab, 90
 —, width of slab in compression,
 38, 92, 313
- Temperature coefficient of expansion,
 10
- Test blocks, 241, 309
 — loads, 235, 310
- Torsion on beams, 192, 193
- VIBRATION**, general, 239, 309
- Vibration, as affecting the equivalent
 dead load, 310
 —, as affecting the working stress
 on columns, 99
- WATER** tanks, 74, 202
 — tightness, 201
 — towers, 212
- Welding, 308
- Wet and dry concrete, 18
- Wind bracing, 213
- Working stress, 9, 312
 —, as affected by varying magni-
 tude of stresses, 22

THE END



juv
350 a
nu

TA 683
F2

263603
Fabru

UNIVERSITY OF CALIFORNIA LIBRARY

